

Styli and accessories

When precision counts, insist on genuine Renishaw styli. Don't settle for less!

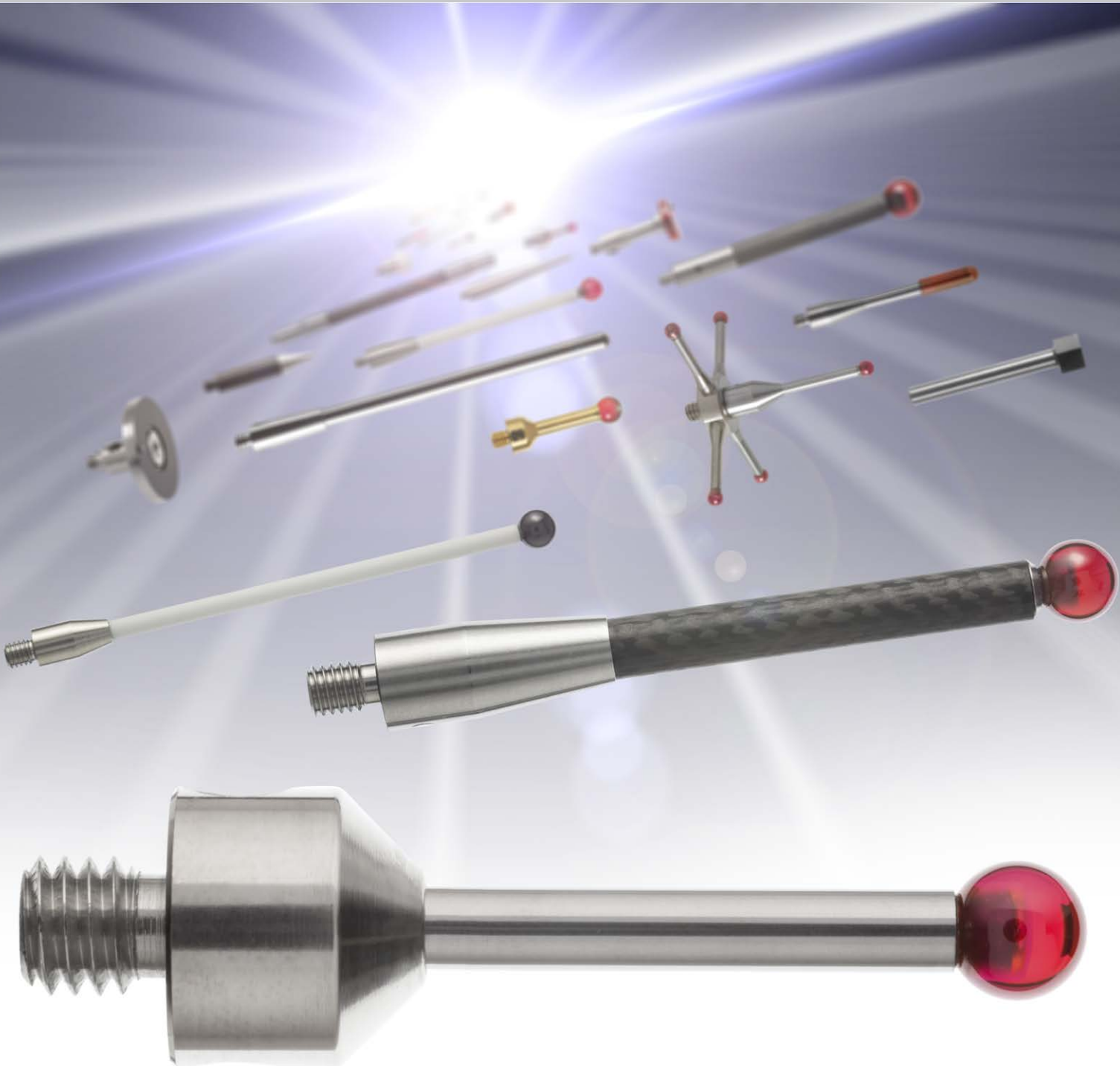

Contents



Section 1

Technical specifications quick reference guides

Quick selection from our extensive range.



Section 2

Accuracy at the point of contact

An explanation of why it is important to choose the right stylus for your application and an overview of the entire range of stylus types.



Section 3

M2 threaded stylus range

Styli for use with the industry standard CMM probes TP2, TP20, TP200 and REVO™.



Section 4

M3 threaded stylus range

Styli for use with manual CMM probes TP1 and TP6 and the most flexible scanning probe, SP25M and REVO™.



Section 5

M4 threaded stylus range

Optimised for stiffness and weight, styli purposefully designed for the high accuracy TP7M and our comprehensive range of probing for machine tools.



Section 6

M5 threaded stylus range

A premium range specifically designed for highest accuracy scanning probes from Renishaw and other manufacturers.



Section 7

Styli for Faro arms

These styli have been designed especially for use on Faro portable arm CMMs.



Section 8

Accessories

All of the 'bits and pieces' that you need to assemble anything from the most complex stylus clusters to a simple star.

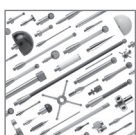

Section 9

Product listing by part number

The complete catalogue presented in part number order.

Technical specifications

Tip material properties

Stylus type	Material	Grade	Deviation from spherical form	Structure	Composition	Purity	Density	Hardness	Compression strength	Bending strength	Fracture toughness K1c
			(μm)	-	(wt%)	(%)	(g/cm^3)	HV	(MPa)	(MPa)	($\text{MN}/\text{m}^{3/2}$)
AL ₂ O ₃ Ruby balls	Synthetic ruby monocrystalline	Grade 5*	0.13	mono	99% AL ₂ O ₃	99.90	3.90	2300	2100	400-700	1
Silicon nitride balls	Hard pressed Si ₃ N ₄	Grade 5*	0.13	poly	Si ₃ N ₄	90	3.0-3.2	1600	3000	850	6
Zirconia oxide balls	Sintered ZrO ₂	Grade 5*	0.13	poly	ZrO ₂	90-95	6.05	1200	2000	1000	10
Alumina hollow balls	White ceramic sintered alumina AL ₂ O ₃	-	1	poly	AL ₂ O ₃	99.80	3.8-3.9	1900	2500	350	3.5
Silver steel discs	Silver steel	-	1	-	-	-	8	450	-	-	-
Silver steel simple cylinder	Silver steel	-	Roundness 4 μm	-	-	-	8	200	-	-	-
Ruby ball ended cylinder	Synthetic ruby	Ball: Grade 5*	Ball deviation from spherical form : 0.13	mono	99% AL ₂ O ₃	99.90	3.99	2300	2300	400-700	1
Tungsten carbide ball ended cylinder	Tungsten carbide	-	+ 20 μm end radius	-	92-93.5% WC 6.5-8% CO	14.8	14.95	1550	6000	-	-
Silver steel simple pointer	Silver steel	-	Cone angle 30°	-	-	-	8	300	-	-	-
Tungsten carbide radius end pointer	Tungsten carbide	-	Cone angle 30°	-	92-93.5% WC 6.5-8% CO	99.90	15	1550	6000	-	-
Aluminium hollow balls	Al. alloy 6082-T6	-	30 μm	-	95.2-98.3% AL	-	2.7	95	-	-	-

* Refers to DIN-5401 ball grade standard
** Grade 3 sphericity balls are available on request.

Extension material properties

Material	Coefficient of expansion @25°C
Stainless steel	$16 \times 10^{-6}/^\circ\text{C}$
Tungsten carbide	$5 \times 10^{-6}/^\circ\text{C}$
White ceramic sintered alumina	$8.1 \times 10^{-6}/^\circ\text{C}$
Carbon fibre	$-0.4 \times 10^{-6}/^\circ\text{C}$
Titanium	$9.2 \times 10^{-6}/^\circ\text{C}$
Ruby	$4.5 \times 10^{-6}/^\circ\text{C}$
Silicon nitride	$3.2 \times 10^{-6}/^\circ\text{C}$
Zirconia	$10.5 \times 10^{-6}/^\circ\text{C}$

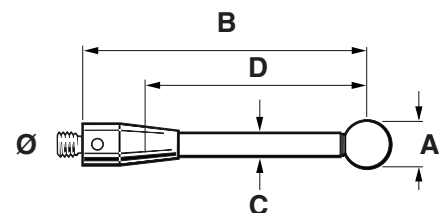

- A** Ball diameter
- B** Overall length
- C** Stem diameter
- D** Effective working length
- Ø M2 = 3 mm
- Ø M3 = 4 mm
- Ø M4 = 7 mm
- Ø M5 = 10 mm

M2 styli and extensions quick reference guide*

Ruby ball / stainless steel stem

Ball diameter	1.0 (0.4)	1.5 (0.06)	2.0 (0.08)	2.5 (0.10)	3.0 (0.12)	4.0 (0.16)	5.0 (0.20)	6.0 (0.24)	8.0 (0.32)
Length 10 mm	A-5000-7806	A-5000-7802	A-5000-7807	A-5000-7803	A-5000-3604	A-5000-4154	A-5000-4155	A-5000-4156	A-5000-4158
20 mm	–	–	A-5000-3603	A-5000-7804	A-5000-4160	A-5000-4161	–	–	–

Ruby ball / tungsten carbide stem

Ball diameter	0.3 (0.012)	0.5 (0.020)	0.7 (0.028)	1.0 (0.04)	1.5 (0.06)	2.0 (0.08)	2.5 (0.10)	3.0 (0.12)	4.0 (0.16)	5.0 (0.20)
Length 10 mm	A-5000-7800	A-5000-7805	A-5000-7801	A-5003-1325	–	–	–	–	–	–
20 mm	–	A-5003-1345	A-5003-0577	A-5000-7808	A-5003-0034	A-5003-3822	A-5003-1896	A-5003-0938	A-5003-1029	A-5003-0046
30 mm	–	–	–	A-5000-8663	A-5003-0035	A-5003-0036	A-5003-0038	A-5003-0040	A-5003-0043	A-5003-0047
40 mm	–	–	–	–	–	A-5003-0037	A-5003-0039	A-5003-0041	A-5003-0044	A-5003-0048
50 mm	–	–	–	–	–	–	–	A-5003-0042	A-5003-0045	A-5003-0049

Ruby ball / ceramic stem

Ball diameter	3.0 (0.12)	4.0 (0.16)	5.0 (0.20)	6.0 (0.24)
Length 30 mm	A-5003-4177	A-5003-1370	A-5003-4779	A-5003-4780
50 mm	A-5003-0064	A-5003-0065	A-5003-0066	A-5003-0470

Ruby ball / carbon fibre stem

Ball diameter	4.0 (0.16)	5.0 (0.20)	6.0 (0.24)
Length 30 mm	A-5003-4241	A-5003-4781	A-5003-4782
50 mm	A-5003-2285	A-5003-2286	A-5003-2287
75 mm	A-5003-4784	A-5003-4785	A-5003-4786
100 mm	A-5003-2289	A-5003-2290	A-5003-2291

Stylus extensions

Length	5.0 (0.20)	10.0 (0.40)	20.0 (0.79)	30.0 (1.19)	40.0 (1.58)	50.0 (1.97)	70.0 (2.76)	90.0 (3.55)
Stainless steel	A-5004-7610	A-5004-7585	A-5004-7586	A-5004-7591	A-5004-7611	–	–	–
Ceramic	–	–	–	A-5003-0070	A-5003-0071	A-5003-0072	–	–
Carbon fibre	–	–	–	–	A-5003-2280	A-5003-2281	A-5003-2282	A-5003-2283

* These are a selection of the most popular styli

M3 styli and extensions quick reference guide*

Ruby ball / stainless steel stem

Ball diameter		1.0 (0.04)	2.0 (0.08)	3.0 (0.12)	4.0 (0.16)	5.0 (0.20)
Length	21 mm	A-5000-3551	A-5000-3552	A-5000-3553	A-5000-7606	A-5000-7630
	31 mm	–	–	–	A-5000-3554	A-5000-7648

Ruby ball / tungsten carbide stem

Ball diameter		0.5 (0.020)	1.5 (0.06)	2.0 (0.08)	2.5 (0.10)	3.0 (0.12)	4.0 (0.16)	5.0 (0.20)
Length	21 mm	A-5000-7632	A-5003-0050	–	A-5003-0054	–	–	–
	30 mm	–	A-5003-0051	A-5003-0052	A-5003-0055	A-5003-0057	–	–
	40 mm	–	–	A-5003-0053	A-5003-0056	A-5003-0058	A-5003-0060	A-5003-0062
	50 mm	–	–	–	–	A-5003-0059	A-5003-0061	A-5003-0063

Ruby ball / ceramic stem

Ball diameter		3.0 (0.12)	4.0 (0.16)	5.0 (0.20)
Length	50 mm	A-5003-0067	A-5003-0068	A-5003-0069

Ruby ball / carbon fibre stem

Ball diameter		6.0 (0.24)	8.0 (0.32)
Length	75 mm	A-5003-4860	A-5003-4862
	100 mm	A-5003-4861	A-5003-4863

Stylus extensions

Length	10.0 (0.40)	20.0 (0.79)	35.0 (1.38)	50.0 (1.97)	75.0 (2.95)	100.0 (3.94)
Stainless steel	A-5004-7609	A-5004-7583	A-5004-7584	–	–	–
Ceramic	–	–	–	A-5003-0075	–	–
Carbon fibre	–	–	–	–	A-5003-4864	A-5003-4865

*These are a selection of the most popular styli

M4 styli and extensions quick reference guide*

Ruby ball / stainless steel stem

Ball diameter	1.0 (0.04)	2.0 (0.08)	3.0 (0.12)	4.0 (0.16)	5.0 (0.20)	6.0 (0.24)	8.0 (0.32)
Length 10 mm	–	–	–	–	A-5000-6350	–	–
20 mm	A-5000-7545	A-5000-7547	A-5000-7549	A-5000-7551	–	A-5000-7555	A-5000-7557
30 mm	–	–	–	–	A-5000-6352	–	–
50 mm	–	–	–	–	A-5000-7521	–	–
100 mm	–	–	–	–	A-5000-7522	–	–

Ruby ball / tungsten carbide stem

Ball diameter	1.0 (0.04)	2.0 (0.08)	3.0 (0.12)	4.0 (0.16)	5.0 (0.20)	6.0 (0.24)
Length 20 mm	A-5003-4792	A-5003-2932	A-5003-4793	A-5003-4794	A-5003-4795	A-5003-4796
50 mm	–	A-5003-4797	A-5003-3680	A-5003-4799	A-5003-4800	A-5003-4801

Ruby ball / ceramic stem

Ball diameter	5.0 (0.20)	6.0 (0.24)	8.0 (0.32)
Length 50 mm	A-5003-0235	A-5000-3709	A-5000-7795
75 mm	A-5003-0236	A-5003-2764	A-5003-4802
100 mm	A-5000-9761	A-5000-3712	A-5000-7796

Ruby ball / carbon fibre stem

Ball diameter	6.0 (0.24)	8.0 (0.32)
Length 50 mm	A-5003-1436	–
100 mm	A-5003-1358	–
150 mm	A-5003-1255	–
200 mm	A-5003-1075	–
300 mm	–	A-5003-3461

Stylus extensions

Length	10.0 (0.40)	15.0 (0.60)	20.0 (0.79)	30.0 (1.19)	50.0 (1.97)	100.0 (3.94)
Stainless steel	A-5004-7599	A-5004-7600	A-5004-7601	A-5004-7602	–	–
Ceramic	–	–	–	A-5000-7754	A-5000-7755	A-5000-7727

*These are a selection of the most popular styli

M5 styli and extensions quick reference guide*

Ruby ball / tungsten carbide stem

Ball diameter	0.3 (0.012)	0.5 (0.020)	0.7 (0.028)	1.0 (0.04)	1.5 (0.06)	2.0 (0.08)	2.5 (0.10)	3.0 (0.12)	4.0 (0.16)	5.0 (0.20)
Length 20 mm	A-5003-5201	A-5003-5202	A-5003-5203	A-5003-5204	A-5003-5205	A-5003-5206	A-5003-5207	A-5003-5208	A-5003-5209	A-5003-5210
30 mm	A-5003-5211	A-5003-5212	A-5003-5213	A-5003-5214	A-5003-5215	A-5003-5216	A-5003-5217	A-5003-5218	A-5003-5219	A-5003-5220
40 mm	–	–	–	–	A-5003-5221	A-5003-5222	A-5003-5223	A-5003-5224	–	–
50 mm	A-5003-5225	A-5003-5226	A-5003-5227	A-5003-5228	A-5003-5229	A-5003-5230	A-5003-5232	A-5003-5234	A-5003-5235	A-5003-5236
75 mm	A-5003-5240	A-5003-5241	A-5003-5242	A-5003-5243	A-5003-5244	–	–	A-5003-5253	A-5003-5248	A-5003-5249
100 mm	–	–	–	–	–	–	A-5003-5254	–	–	–

Ruby ball / carbon fibre stem

Ball diameter	2.5 (0.10)	6.0 (0.24)	8.0 (0.32)	10.0 (0.40)
Length 20 mm	–	–	–	–
30 mm	–	–	–	–
40 mm	–	–	–	–
50 mm	–	A-5003-5237	A-5003-5238	A-5003-5239
75 mm	–	A-5003-5250	A-5003-5251	A-5003-5252
100 mm	–	A-5003-5259	A-5003-5261	A-5003-5263
150 mm	–	A-5003-5265	A-5003-5266	A-5003-5267
200 mm	–	A-5003-5268	A-5003-5269	A-5003-5270
300 mm	–	A-5003-5271	A-5003-5272	A-5003-5273

Stylus extensions

Length	10.0 (0.40)	20.0 (0.79)	30.0 (1.19)	40.0 (1.58)	50.0 (1.97)	60.0 (2.37)	70.0 (2.76)	80.0 (3.15)	90.0 (3.55)	100.0 (3.94)
CF/Titanium (Ø11 mm)	–	–	–	A-5555-0647	A-5555-0648	A-5555-0649	A-5555-0623	A-5555-0650	A-5555-0651	A-5555-0652
CF/Titanium (Ø20 mm)	–	–	–	A-5555-0620	A-5555-0657	A-5555-0658	–	A-5555-0621	–	A-5555-0659
Stainless steel	A-5555-0142	A-5555-0140	A-5555-0669	–	A-5555-0670	–	–	–	–	A-5555-0136
Aluminium tube	–	–	–	–	A-5555-0671	–	–	–	–	A-5555-0127

Length	120.0 (4.73)	150.0 (5.91)	180.0 (7.09)	200.0 (7.88)	250.0 (9.85)	300.0 (11.82)	400.0 (15.76)	500.0 (19.70)	600.0 (23.64)
CF/Titanium (Ø11 mm)	A-5555-0425	A-5555-0424	A-5555-0653	A-5555-0654	A-5555-0655	A-5555-0642	A-5555-0656	–	–
CF/Titanium (Ø20 mm)	A-5555-0660	A-5555-0621	A-5555-0662	A-5555-0663	A-5555-0427	A-5555-0664	A-5555-0665	A-5555-0667	A-5555-0668
Stainless steel	–	–	–	–	–	–	–	–	–
Aluminium tube	–	–	–	A-5555-0125	–	–	–	–	–

*These are a selection of the most popular styli

Accuracy at the point of contact

2.1



Accuracy at the point of contact

As industry has developed its requirement for increasingly diverse and complex manufactured parts, inspection systems have had to work hard to keep up. The use of co-ordinate measuring machines (CMMs) with probing systems and in-process inspection on machine tools are two of the solutions offered by Renishaw to help you maximise your productivity and maintain the highest quality.

Successful gauging depends very much on the ability of the probe's stylus to access a feature and then maintain accuracy at the point of contact. At Renishaw, we have used our expertise in probe and stylus design to develop a comprehensive range of CMM and machine tool styli to offer you the greatest possible precision.

These notes explain the critical features of every stylus type, helping you to choose the right design for each inspection need.

What is a stylus?

A stylus is that part of the measuring system which makes contact with the component, causing the probe's mechanism to displace. The generated signal enables a measurement to be taken. The feature to be inspected dictates the type and size of stylus used. In all cases, however, maximum rigidity of the stylus and perfect sphericity of the tip are vital.

To achieve this, Renishaw's stylus stems are produced on CNC machine tools to exacting standards. Great care is taken to ensure that location faces give maximum stiffness whilst stylus mass is optimised to suit Renishaw's range of probes.

Genuine Renishaw stylus balls are produced to the highest standards and are bonded to the stems in such a way as to ensure maximum joint integrity.

The performance of your gauging can easily be degraded if you use a stylus with poor ball roundness, poor ball location, bad thread fit or a compromised design that allows excessive bending during measurement. To ensure the integrity of the data you gather, make certain that you specify and use a stylus from the comprehensive range of genuine Renishaw styli.

What naming protocol do Renishaw use to describe their styli range?

Renishaw uses the following naming protocol to allow easy identification of styli by name and part number. The examples below show how this protocol is assigned and describe the abbreviations used:

Straight styli

M2 STY D2R L20 EWL14 d1.4SS

The above protocol describes an M2 threaded straight stylus fitted with a 2 mm diameter ruby ball. It has an overall length of 20 mm, has an effective working length (EWL) of 14 mm and has a 1.4 mm diameter stainless steel stem.

Star styli

M2 STR D2R L20 5BALL L19.5 S32

The above protocol describes an M2 threaded star stylus fitted with a 2 mm diameter ruby ball. It has 5 balls on the star and an overall length of 19.5 mm (from the centre of the ball to the rear of the star mounting face when assembled to a probe). The span of the star cluster is 32 mm.

Disc styli

M2 DSC SD18 SLVS T2.2 L2.6 BR-Y

The above protocol describes an M2 threaded disc stylus with a spherical diameter disc of 18 mm. It is made from silver steel with a disc thickness of 2.2 mm and a length of 2.6 mm. BR stands for balls/rollers followed by yes (Y) or no (N).

Cylinder styli

M2 CYL D3 SLVS L13 EWL4

The above protocol describes an M2 threaded cylinder stylus with a critical measuring element diameter of 3 mm made from silver steel. It has an overall length of 13 mm and an EWL of 4 mm.

Extensions

M4 EXT L15 d7 SS

The above protocol describes an M4 threaded extension with a length of 15 mm diameter and a diameter of 7 mm. The extension is made from stainless steel.

Terminology

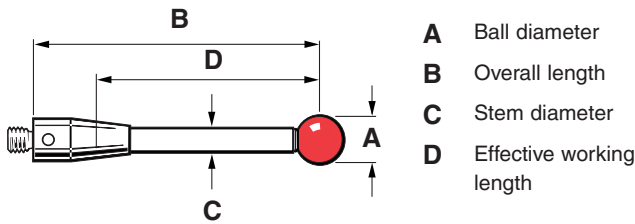

Overall length

Renishaw uses a standard description of overall length, measuring from the rear mounting face of the stylus to the centre of the ball.

Effective working length (EWL)

This is measured from the centre of the ball to the point at which the stem will foul against the feature when measuring 'normal' to the part.

Choosing a stylus

To maintain accuracy at the point of contact we recommend that you:

Keep styli short

The more that a stylus bends or deflects, the lower the accuracy. Probing with the minimum stylus length for your application is the best option.

Minimise joints

Every time you join styli and extensions, you introduce potential bending and deflection points. Try, wherever possible, to keep to the minimum number of pieces for your application.

Keep the ball as large as possible

There are two reasons for this;

- firstly, it maximises your ball/stem clearance thereby reducing the chances for false triggers caused by 'shanking out' on the stylus stem
- secondly, the larger ball reduces the effect of the surface finish of the component being inspected.

The range of genuine Renishaw styli

Ball material

Ruby

The industry standard and the optimum stylus ball material for a vast majority of measurement applications, ruby is one of the hardest known materials. Synthetic ruby is 99% pure aluminium oxide which is grown into crystals (or "boules") at 2000 °C using the Verneuil process.

The boules are then cut and gradually machined into a highly spherical form. Ruby balls are exceptionally smooth on the surface, have great compressive strength and a high resistance to mechanical corrosion.

Very few applications exist where ruby is not the preferred ball material, however there are two applications where balls manufactured from other materials are recommended.

The first is for heavy duty scanning applications on aluminium. Because the materials attract, a phenomenon known as 'adhesive wear' can occur which involves build up of aluminium from the surface onto the ball. A better ball material for such applications is silicon nitride.

The second is in heavy duty scanning applications on cast iron. Interaction between the two materials can result in 'abrasive wear' of the ruby ball surface. For such applications, Zirconia balls are recommended.

Silicon nitride

Silicon nitride possesses many similar properties to ruby. It is a very hard and wear-resistant ceramic which can be machined into very high precision spheres. It can also be polished to an extremely smooth surface finish. Silicon nitride does not have the attraction to aluminium and so does not exhibit the adhesive wear seen with ruby in similar applications. However, silicon nitride does show significant abrasive wear characteristics when scanning on steel surfaces and so its applications are best confined to aluminium.

Zirconia

Zirconia is a particularly tough ceramic material with hardness and wear characteristics approaching those of ruby. Its surface properties make it an ideal material for aggressive scanning applications on cast iron components.

Stem material

Steel

Stylus stems manufactured from stainless steel are used widely for styli with ball/tip diameters of 2 mm or greater and with lengths up to 30 mm. Within this range, one-piece steel stems offer the optimum stiffness to weight ratio, giving adequate ball/stem clearance without compromising stiffness with a joint between the stem and threaded body.

Please contact us if you require any styli with special ball materials. We can recommend the most suitable material for scanning different materials

Styli and accessories

Tungsten carbide

Tungsten carbide stems are best used for maximising stiffness with either small stem diameters required for ball diameters of 1 mm and below, or lengths up to 50 mm. Beyond this, weight can become a problem and stiffness is lost due to deflection at the stem to body joint.

Ceramic

For ball diameters greater than 3 mm, and lengths over 30 mm, ceramic stems offer stiffness comparable to steel but are significantly lighter than tungsten carbide. Ceramic stemmed styli can also offer additional crash protection to your probe as the stem will shatter in a collision.

Carbon fibre (Renishaw GF)

There are many grades of carbon fibre materials. However, Renishaw GF combines optimum stiffness characteristics, both longitudinally and in torsion (important in star constructions), with extremely low weight. Carbon fibre is inert and this, combined with a special resin matrix, provides excellent protection in the most hostile of machine tool environments.

Renishaw GF is ideal for maximising stiffness while giving very low mass for styli above 50 mm in length. It is the optimum stem material for high accuracy strain gauge technology probes with excellent vibration damping characteristics and negligible co-efficient of thermal expansion.

The genuine Renishaw stylus range comprises several types:

Straight styli



These are the simplest form of stylus, incorporating highly spherical industrial ruby balls and a choice of stem material.

Ruby is an extremely hard material and hence stylus wear is minimised. It is also of low density, keeping tip mass to a minimum, which avoids unwanted probe triggers caused by machine motion or vibration.

Mounted on stems made from a range of materials – stainless steel, tungsten carbide, ceramic and a specialised carbon fibre material, “Renishaw GF” – these simple ruby ball styli are suitable for most inspection applications.

Each stylus has an effective working length (EWL) which is the penetration that can be achieved by the ball before the stem fouls against the feature.

The size of the ball and the EWL of the stylus chosen are dictated by the size of the feature to be inspected. However, keeping the stylus ball as large as possible and the stem as short as possible will ensure maximum ball/stem clearance, whilst providing a greater yet still rigid EWL. Using larger ruby balls also reduces the effect of the surface finish of the component being inspected.

Probing with very long stylus/extension combinations is not recommended with standard kinematic touch trigger probes as the rigidity is reduced and accuracy lost due to stylus bending. This is not the case with other types of probe such as those with strain gauge technology, as their very low trigger forces permit the use of long stylus/extension combinations without a significant loss of accuracy.

Star styli

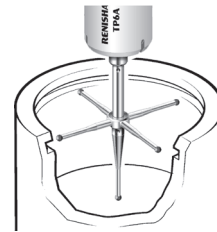

These stylus clusters provide you with multiple-tip probing of complex features and bores. Four or five ruby ball systems are mounted rigidly on a stainless steel centre. Three standard sizes are offered – alternatively, you can create custom-made star styli using a 5-way stylus centre and any of the genuine Renishaw stylus range.

Star styli can be used to inspect a variety of different features. Their use can reduce inspection cycle times by allowing multi-tip probing, minimising the need to move the probe to extreme points of internal features such as the sides or grooves in a bore. Using star styli also allows effective probing in the $-Z$ (upwards) direction when using a 5-way probe, provided that the stylus tips extend beyond the diameter of the probe body. Each tip on a star stylus requires datuming (sometimes referred to as ‘qualifying’ or ‘calibrating’) in the same manner as a single-ball stylus. The ‘span’ of star styli is taken from ball centre to ball centre.

Disc styli



These styli are used to probe undercuts and grooves within bores which may be inaccessible to star styli. They are ‘sections’ of highly spherical balls and are available in various diameters and thicknesses. Full rotational adjustment and the ability to add a centre stylus are features of the Renishaw range of disc styli that make them particularly flexible and easy to use.

Probing with the 'spherical edge' of a simple disc is effectively the same as probing on or about the equator of a large stylus ball. However, only a small area of this ball surface is available for contact and hence thinner discs require careful angular alignment in order to ensure correct contact with the feature being probed.

A simple disc requires datuming for only one diameter (usually in a ring gauge), but limits effective probing to only X and Y directions.

Adding a 'radius end roller' allows you to datum and hence probe in the Z direction, provided that the centre of the 'radius end roller' extends beyond the diameter of the probe. The 'radius end roller' can be datumed on a sphere or a slip gauge. Rotating and locking the disc about its centre axis allows the 'radius end roller' to be positioned to suit the application.

Discs may also have a threaded centre to allow the fixing of a centre stylus, giving the additional flexibility of probing the bottom of deep bores (where access for the disc may be limited).

Styli for specialist applications

A range of specialist styli is available to enable probing of features such as thread form, thin sectioned material, tool setting and other specialist applications.

Cylinder styli



These are used for probing holes in thin sheet material. In addition, various threaded features can be probed and the centres of tapped holes located. Ball-ended cylinder styli allow full datuming and probing in X, Y and Z directions, thus allowing surface inspection to be performed.

Pointer and ceramic hollow ball styli



Pointer styli are designed for the inspection of thread forms, specific points and scribed lines (to lower accuracy). The use of a radius end pointer stylus allows more accurate datuming and probing of features as detailed above and can also be used to inspect the location of very small holes.

Ceramic hollow ball styli are ideal for probing deep features and bores in X, Y and Z directions, with the need to datum only one ball. There are two versions in the range, 18 and 30 mm diameter, specially designed for the TP2 / TP20 / TP200 and TP6 probes respectively. Probing with such a large diameter ball can average out the effects of very rough surfaces.

Tool setting styli



Typically, these are fitted with a square tip and can have threaded or plain shaft attachments. The tip faces are ground to ensure high squareness and parallelism. The TS27R tool setting probe for machining centres can also be fitted with a tungsten carbide disc stylus.

Crash protection devices



Renishaw's stylus crash protection devices are designed to break in the event of impact and protect the probe from damage.

Accessories and tools

A wide range of accessories including extensions, 4 and 5-way centres and stylus knuckles complement the genuine Renishaw stylus range to achieve fully flexible inspection.

Stylus centres



These provide maximum probing flexibility with a single probe. Taking up to five styli of the same mounting thread, this accessory allows you to build stylus configurations to your own specification.

Stylus knuckles



These give full adjustment about two axes, allowing the stylus to be orientated to probe angled features. This adjustment is especially useful when the probe cannot be correctly orientated by the probe head, or when access for the head is limited.

Stylus extensions



These provide additional probing penetration by extending the stylus away from the probe. However, using stylus extensions can reduce probe accuracy due to loss of rigidity. This is not the case with electronic probes, whose extremely low trigger forces render them less sensitive to this type of inaccuracy.

Stylus thread adaptors



These allow M2, M3, M4 and M5 threaded styli to be interchanged on the majority of touch trigger probes. They are particularly useful for adapting the extensive range of specialised application M2 styli for use on larger probes.

Stylus tools

Specifically designed for mounting styli correctly onto probes and for the construction of specialised stylus combinations, Renishaw's stylus tools protect your investment.

The S7 stylus tool



The stylus tool is used for tightening styli and accessories when connecting to one another or directly into the probe. It is specifically designed to yield if excessive tightening force is applied, avoiding damage to the threads of stylus and probe.

A stylus crank



A stylus crank can allow access to features that are otherwise difficult to reach, and are often used in lathe inspection applications.

Renishaw stylus kits

Renishaw styli and accessories are available in a wide selection of kits, ranging from a small precision set of the most frequently used styli, to a comprehensive set to meet virtually every inspection need.

Some sets are housed in a quality wooden case for maximum protection and superb presentation. The styli are held in a wood insert, individually located in a nylon sleeve providing protection for the mounting threads. This type of box features a removable module which houses up to twelve ruby ball styli and contains a tray for discs, tools and accessories. This allows the stylus selection for a particular inspection task to be brought to the CMM's table. The sloping lid design of this kit provides easy access to styli, minimising handling of ruby balls and contact surfaces, thus aiding cleanliness.

Probing kits are also available to include a probe, probe head, extension bars and styli.

Custom design service

Renishaw's Styli division offers a unique service by providing customers with a total custom stylus solution for their probing needs for CMM, machine tool, Equator or scanning applications, where a standard stylus may not be suitable.

The division includes expertise in applications, design, engineering and manufacturing with extensive experience in providing tailor-made stylus product solutions to specific customer's requirements.

Our expertise allows us to develop a product that satisfies customer demand for accuracy, piece part feature inspection, delivery and cost. All of these aspects are considered within the design of a custom stylus, ensuring that the solution incorporates the ideal choice of ball & stem materials and optimises probe performance for your particular application.

Renishaw's Styli division has designed over 10,000 different custom styli for a wide range of probing applications worldwide ranging from aeronautical & automotive to high volume manufacturing, so the solution to your application problem may already exist.

For advice and further details, please contact your nearest Renishaw distributor.

We always recommend using Renishaw styli in order to maximise your quality & probing performance.

Custom stylus request form

Please complete the form and send it back to us. Our design team will review the supplied information and present you with a solution for your application.

Customer _____	Customer email _____
Company _____	Customer telephone _____

Stylus information

Type of stylus (please indicate on diagrams below) Other* * Please attach as much information as possible, including a sketch of the stylus.

Thread M2 M3 M4 M5 Other _____

Tip material Ruby Silicon nitride Stainless steel Tungsten carbide Zirconia

Stem material Carbon fibre Ceramic Stainless steel Tungsten carbide

Quantity of styli required _____

Type of stylus Dimensions given are: Metric (mm) Imperial (in)

A

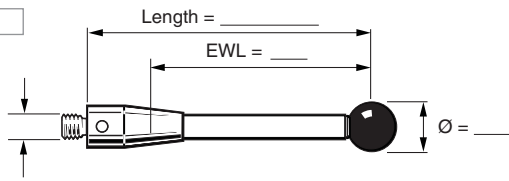

C

Is there a ball/roller? Yes No

If yes, please specify height of ball/roller: _____

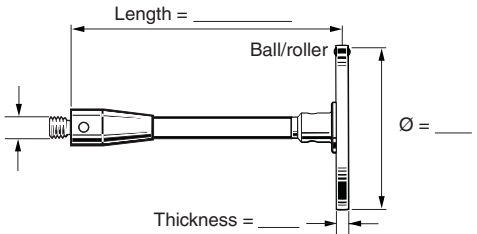

B

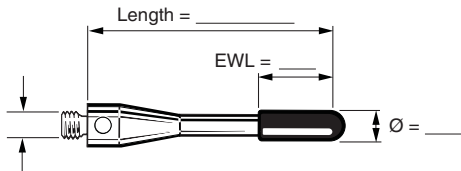

Probe information	Orientation Vertical <input type="checkbox"/> Horizontal <input type="checkbox"/>
Type of probe _____	Application Scanning <input type="checkbox"/> Inspection <input type="checkbox"/>
Material being measured _____	

Additional information

Grade 3 high accuracy styli

With the increased use of very high accuracy CMMs, the specification of the stylus ball has become a significant factor when calculating error budgets. High precision measuring machines require precision styli. Renishaw offers grade 3 styli with a form deviation of ± 0.08 microns.

The sphericity of your stylus ball can affect your CMM measurements. To ensure the accuracy of your measurements, use a minimum of AFBMA 3290 / DIN 5401-11.1993 Grade 5 balls.

As standard, Renishaw uses Grade 5 stylus balls with a sphericity of $0.13 \mu\text{m}$ and not the lesser Grade 10 balls that most other manufacturers use.

Grade 3 balls, with a sphericity of $0.08 \mu\text{m}$, are also available.

Grade 3 ball design considerations:

Investigations into the effect of the design and construction of styli using such a highly specified ball have indicated that the form of the ball can be degraded by machining a hole in it and through distortion from gluing it onto a spigot. Renishaw has researched ways to improve the design of the high accuracy Grade 3 ball styli.

All Grade 3 styli being produced by Renishaw are constructed using an undrilled ball bonded into a spherical cup. Measurements taken before and after assembly of this design have shown that the form of the ball remains well within specification throughout the process.

In order to easily identify a Grade 3 ball stylus, the stems are coated in Titanium Nitride, giving them a gold coloured finish.

Due to limits of measurement capability and bond strength, Grade 3 ball styli are only available with a minimum ball diameter of 1 mm. The styli are not serialised and are supplied with a certificate of roundness.

Contact your local Renishaw office for more details.

M2 threaded stylus range

3.1









REVO® 5-axis measurement multi-sensor system





Renishaw's probing systems are designed to give optimum performance using styli from Renishaw's comprehensive range. The following probes all use M2 threaded styli, however, with suitable adaptors, other thread sizes may be used.

- TP2
- TP20
- TP200
- REVO®







Ruby ball styli (stainless steel stems)

Ball material		Part number								
Ruby		A-5000-7806	A-5000-7802	A-5000-7807	A-5000-7803	A-5000-3604	A-5000-4154	A-5000-4155	A-5000-4156	A-5000-4158
Silicon nitride		A-5004-0210	A-5004-1918	A-5003-6120	A-5004-1920	A-5003-2138	A-5003-9524	A-5004-1921	A-5004-0237	A-5004-1922
Zirconia		A-5003-7757	A-5004-0165	A-5003-7723	A-5004-2913	A-5004-2914	A-5003-7261	A-5003-2186	A-5004-2203	A-5004-2915
A	Ball dia. mm (in.)	1.0 (0.04)	1.5 (0.06)	2.0 (0.08)	2.5 (0.10)	3.0 (0.12)	4.0 (0.16)	5.0 (0.20)	6.0 (0.24)	8.0 (0.32)
B	Length mm (in.)	10.0 (0.40)	10.0 (0.40)	10.0 (0.40)	10.0 (0.40)	10.0 (0.40)	10.0 (0.40)	10.0 (0.40)	10.0 (0.40)	11.0 (0.44)
C	Stem dia. mm (in.)	0.7 (0.028)	0.7 (0.028)	1.0 (0.04)	1.0 (0.04)	1.5 (0.06)	1.5 (0.06)	2.5 (0.10)	2.5 (0.10)	2.5 (0.10)
D	EWL* mm (in.)	4.5 (0.18)	4.5 (0.18)	6.0 (0.24)	6.5 (0.25)	7.0 (0.28)	10.0 (0.40)	10.0 (0.40)	10.0 (0.40)	11.0 (0.44)
	Mass grammes	0.3	0.3	0.3	0.3	0.4	0.4	0.7	0.9	1.5
10 mm range										

Ball material		Part number			
Ruby		A-5000-3603	A-5000-7804	A-5000-4160	A-5000-4161
Silicon nitride		A-5003-1730	A-5004-1923	A-5003-6691	A-5004-0236
Zirconia		A-5004-2916	A-5004-2917	A-5004-1057	A-5004-2918
A	Ball dia. mm (in.)	2.0 (0.08)	2.5 (0.10)	3.0 (0.12)	4.0 (0.16)
B	Length mm (in.)	20.0 (0.79)	20.0 (0.79)	20.0 (0.79)	20.0 (0.79)
C	Stem dia. mm (in.)	1.4 (0.05)	1.4 (0.05)	1.5 (0.06)	1.5 (0.06)
D	EWL* mm (in.)	14.0 (0.56)	16.4 (0.64)	17.0 (0.67)	20.0 (0.79)
	Mass grammes	0.4	0.4	0.5	0.6
20 mm range					

Ruby ball styli (tungsten carbide stems)

Ball material		Part number			
Ruby		A-5000-7800**	A-5000-7805	A-5000-7801	A-5003-1325
Silicon nitride		A-5004-2016**	A-5003-2020		A-5004-2018
Zirconia			A-5003-7672	A-5004-2632	A-5004-2919
A	Ball dia. mm (in.)	0.3 (0.012)	0.5 (0.020)	0.7 (0.028)	1.0 (0.04)
B	Length mm (in.)	10.0 (0.40)	10.0 (0.40)	10.0 (0.40)	10.0 (0.40)
C	Stem dia. mm (in.)	0.2 (0.01)	0.4 (0.02)	0.5 (0.020)	0.7 (0.028)
D	EWL* mm (in.)	2.0 (0.08)	3.0 (0.12)	4.0 (0.16)	4.0 (0.16)
	Mass grammes	0.3	0.3	0.3	0.3
10 mm range					

**Grade 10 balls

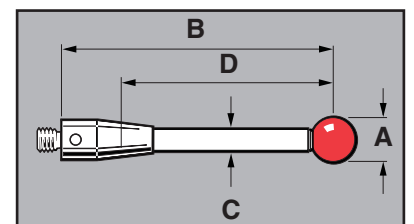

Ruby ball styli (tungsten carbide stems) – continued

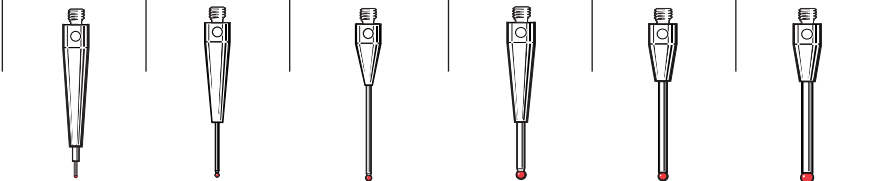
Ball Material		Part number					
Ruby		A-5004-7398	A-5003-1345	A-5003-0577	A-5000-7808	A-5003-0033	A-5003-0034
Silicon nitride		A-5004-7399	A-5004-2019		A-5004-1508	A-5004-2021	A-5004-1925
Zirconia			A-5004-2920	A-5004-1714	A-5004-0435	A-5004-2921	A-5004-2922
A	Ball dia. mm (in.)	0.3 (0.012)	0.5 (0.020)	0.7 (0.028)	1.0 (0.04)	1.0 (0.04)	1.5 (0.06)
B	Length mm (in.)	20.0 (0.79)	20.0 (0.79)	20.0 (0.79)	20.0 (0.79)	20.0 (0.76)	20.0 (0.76)
C	Stem dia. mm (in.)	0.2 (0.01)	0.3 (0.012)	0.5 (0.020)	0.7 (0.028)	0.8 (0.04)	1.0 (0.04)
D	EWL* mm (in.)	2.0 (0.08)	7.0 (0.28)	12.0 (0.48)	7.0 (0.28)	12.5 (0.50)	12.5 (0.50)
	Mass grammes	0.50	0.48	0.32	0.50	0.41	0.50
20 mm range							

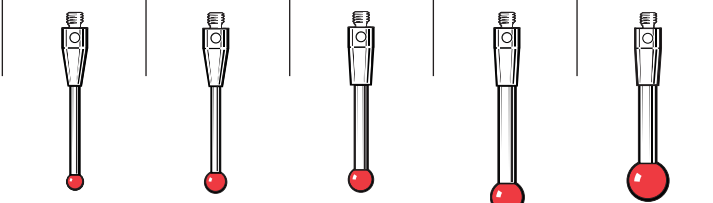

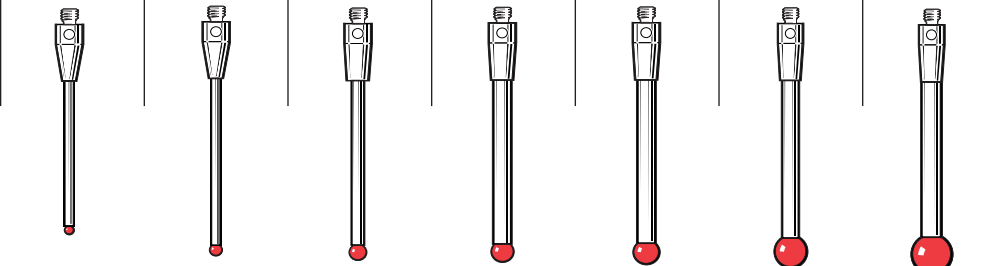

Ball material		Part number				
Ruby		A-5003-3822	A-5003-1896	A-5003-0938	A-5003-1029	A-5003-0046
Silicon nitride		A-5004-1017	A-5004-1928	A-5004-1021	A-5004-1929	A-5004-1930
Zirconia		A-5004-2923	A-5004-2924	A-5004-0437	A-5004-2925	A-5004-2926
A	Ball dia. mm (in.)	2.0 (0.08)	2.5 (0.10)	3.0 (0.12)	4.0 (0.16)	5.0 (0.20)
B	Length mm (in.)	20.0 (0.79)	20.0 (0.79)	20.0 (0.79)	22.0 (0.87)	20.0 (0.79)
C	Stem dia. mm (in.)	1.0 (0.04)	1.0 (0.04)	1.5 (0.06)	2.0 (0.08)	2.5 (0.10)
D	EWL* mm (in.)	14.0 (0.55)	15.5 (0.62)	17.0 (0.67)	22.0 (0.87)	20.0 (0.79)
	Mass grammes	0.48	0.50	0.77	1.24	1.98
20 mm range						

Ball material		Part number						
Ruby		A-5000-8663	A-5003-0035	A-5003-0036	A-5003-0038	A-5003-0040	A-5003-0043	A-5003-0047
Silicon nitride		A-5004-2022	A-5004-1931	A-5003-7573	A-5004-1932	A-5004-1933	A-5004-1944	A-5004-1945
Zirconia		A-5004-2927	A-5004-1711	A-5004-1058	A-5004-2928	A-5004-0264	A-5004-2929	A-5004-2930
A	Ball dia. mm (in.)	1.0 (0.04)	1.5 (0.06)	2.0 (0.08)	2.5 (0.10)	3.0 (0.12)	4.0 (0.16)	5.0 (0.20)
B	Length mm (in.)	27.5 (1.08)	30.0 (1.19)	30.0 (1.19)	30.0 (1.19)	30.0 (1.19)	30.0 (1.19)	30.0 (1.19)
C	Stem dia. mm (in.)	0.7 (0.028)	1.0 (0.04)	1.5 (0.06)	2.0 (0.08)	2.0 (0.08)	2.0 (0.08)	2.5 (0.10)
D	EWL* mm (in.)	20.5 (0.81)	22.5 (0.89)	22.5 (0.89)	22.5 (0.89)	27.0 (1.06)	30.0 (1.19)	30.0 (1.19)
	Mass grammes	0.40	0.58	0.99	1.48	1.49	1.57	2.57
30 mm range								

*Effective working length



Ruby ball styli (ceramic stems)

Ball material		Part number			
Ruby		A-5003-4177	A-5003-1370	A-5003-4779	A-5003-4780
Silicon nitride		A-5004-1946	A-5004-1952	A-5004-1953	A-5004-1954
Zirconia		A-5004-2931	A-5004-2932	A-5004-2933	A-5004-2934
A	Ball dia. mm (in.)	3.0 (0.12)	4.0 (0.16)	5.0 (0.20)	6.0 (0.24)
B	Length mm (in.)	30.0 (1.19)	30.0 (1.19)	30.0 (1.19)	30.0 (1.19)
C	Stem dia. mm (in.)	2.0 (0.08)	2.0 (0.08)	2.5 (0.10)	2.5 (0.10)
D	EWL* mm (in.)	27.0 (1.06)	30.0 (1.19)	30.0 (1.19)	30.0 (1.19)
	Mass grammes	0.44	0.68	0.93	1.11

30 mm range				
--------------------	-----------------------------------------------------------------------------------	-----------------------------------------------------------------------------------	-----------------------------------------------------------------------------------	-----------------------------------------------------------------------------------

Ruby ball styli (carbon fibre stems)

Ball material		Part number		
Ruby		A-5003-4241	A-5003-4781	A-5003-4782
Silicon nitride		A-5004-1955	A-5004-1956	A-5004-1957
Zirconia		A-5004-2935	A-5004-2936	A-5004-0618
A	Ball dia. mm (in.)	4.0 (0.16)	5.0 (0.20)	6.0 (0.24)
B	Length mm (in.)	30.0 (1.19)	30.0 (1.19)	30.0 (1.19)
C	Stem dia. mm (in.)	2.0 (0.08)	3.0 (0.12)	3.0 (0.12)
D	EWL* mm (in.)	30.0 (1.19)	30.0 (1.19)	30.0 (1.19)
	Mass grammes	0.57	0.79	0.96

30 mm range			
--------------------	-------------------------------------------------------------------------------------	-------------------------------------------------------------------------------------	-------------------------------------------------------------------------------------

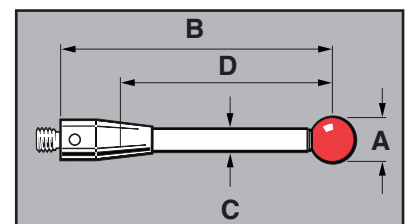

Ruby ball styli (tungsten carbide stems)

Ball material	Part number								
Ruby	A-5003-0037	A-5003-0039	A-5003-0041	A-5003-0044	A-5003-0048	A-5003-0042	A-5003-0045	A-5003-0049	
Silicon nitride	A-5003-7269	A-5004-1959	A-5004-1960	A-5004-1961	A-5004-1962	A-5004-1963	A-5004-1964	A-5004-1965	
Zirconia	A-5004-2937	A-5004-2938	A-5004-1059	A-5004-2939	A-5004-2940	A-5004-2942	A-5004-2943	A-5004-2944	
A	Ball dia. mm (in.)	2.0 (0.08)	2.5 (0.10)	3.0 (0.12)	4.0 (0.16)	5.0 (0.20)	3.0 (0.12)	4.0 (0.16)	5.0 (0.20)
B	Length mm (in.)	40.0 (1.58)	40.0 (1.58)	40.0 (1.58)	40.0 (1.58)	40.0 (1.58)	50.0 (1.97)	50.0 (1.97)	50.0 (1.97)
C	Stem dia. mm (in.)	1.5 (0.06)	2.0 (0.08)	2.0 (0.08)	2.0 (0.08)	2.5 (0.10)	2.0 (0.08)	2.0 (0.08)	2.5 (0.10)
D	EWL* mm (in.)	32.5 (1.28)	32.5 (1.28)	37.0 (1.46)	40.0 (1.58)	40.0 (1.58)	47.0 (1.85)	50.0 (1.97)	50.0 (1.97)
	Mass grammes	1.29	1.95	1.97	2.04	3.17	2.44	2.52	3.75

40 mm – 50 mm range

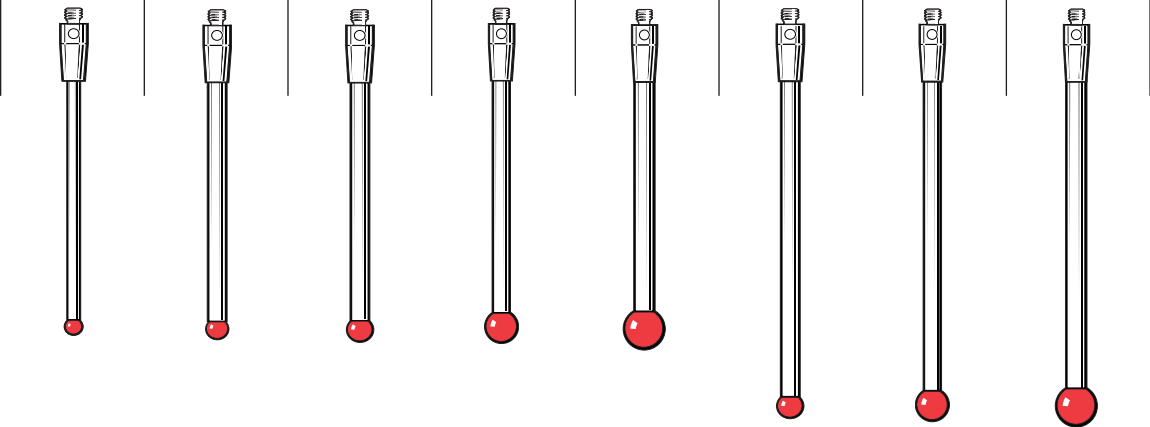

*Effective working length

Ruby ball styli (ceramic stems)

Ball material		Part number			
Ruby		A-5003-0064	A-5003-0065	A-5003-0066	A-5003-0470
Silicon nitride		A-5004-1967	A-5004-1519	A-5004-1968	A-5004-1969
Zirconia		A-5004-2945	A-5004-2946	A-5004-2947	A-5004-2948
A	Ball dia. mm (in.)	3.0 (0.12)	4.0 (0.16)	5.0 (0.20)	6.0 (0.24)
B	Length mm (in.)	50.0 (1.97)	50.0 (1.97)	50.0 (1.97)	50.0 (1.97)
C	Stem dia. mm (in.)	2.0 (0.08)	2.0 (0.08)	2.5 (0.10)	2.5 (0.10)
D	EWL* mm (in.)	47.0 (1.85)	50.0 (1.97)	50.0 (1.97)	50.0 (1.97)
	Mass grammes	0.83	0.91	1.31	1.49

50 mm range

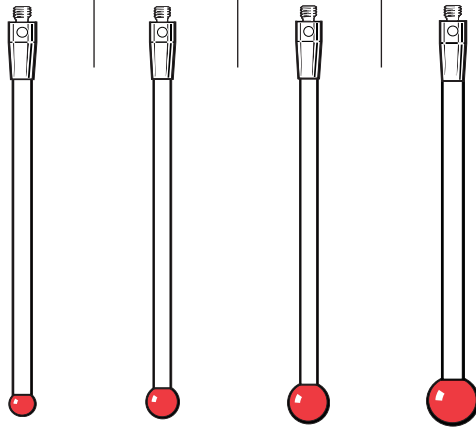

Ruby ball styli (carbon fibre stems)

Ball material		Part number		
Ruby		A-5003-2285	A-5003-2286	A-5003-2287
Silicon nitride		A-5004-1970	A-5004-1971	A-5004-1972
Zirconia		A-5004-1331	A-5004-1330	A-5004-1329
A	Ball dia. mm (in.)	4.0 (0.16)	5.0 (0.20)	6.0 (0.24)
B	Length mm (in.)	50.0 (1.97)	50.0 (1.97)	50.0 (1.97)
C	Stem dia. mm (in.)	3.0 (0.12)	3.0 (0.12)	3.0 (0.12)
D	EWL* mm (in.)	50.0 (1.97)	50.0 (1.97)	50.0 (1.97)
	Mass grammes	1.00	1.10	1.20

50 mm range

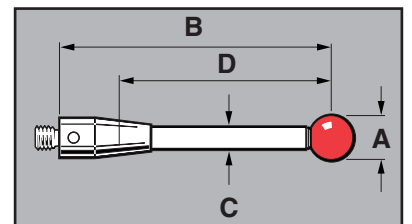
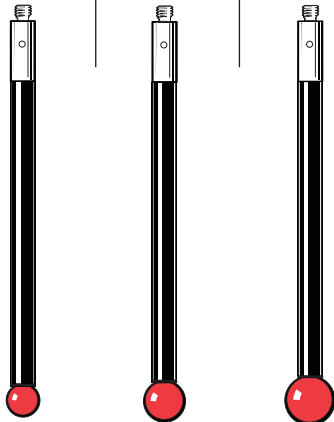

Ruby ball styli (carbon fibre stems) – continued

Ball material	Part number					
Ruby	A-5003-4784	A-5003-4785	A-5003-4786	A-5003-2289	A-5003-2290	A-5003-2291
Silicon nitride	A-5004-1973	A-5004-1974	A-5004-1975	A-5004-1976	A-5004-1977	A-5004-1978
Zirconia	A-5004-2949	A-5004-2950	A-5004-2951	A-5004-2952	A-5004-2953	A-5004-2954
A Ball dia. mm (in.)	4.0 (0.16)	5.0 (0.20)	6.0 (0.24)	4.0 (0.16)	5.0 (0.20)	6.0 (0.24)
B Length mm (in.)	75.0 (2.96)	75.0 (2.96)	75.0 (2.96)	100.0 (3.94)	100.0 (3.94)	100.0 (3.94)
C Stem dia. mm (in.)	2.0 (0.8)	3.0 (0.12)	3.0 (0.12)	3.0 (0.12)	3.0 (0.12)	3.0 (0.12)
D EWL* mm (in.)	75.0 (2.96)	75.0 (2.96)	75.0 (2.96)	100.0 (3.94)	100.0 (3.94)	100.0 (3.94)
Mass grammes	0.75	1.35	1.45	1.50	1.59	1.78

75 mm –
100 mm range

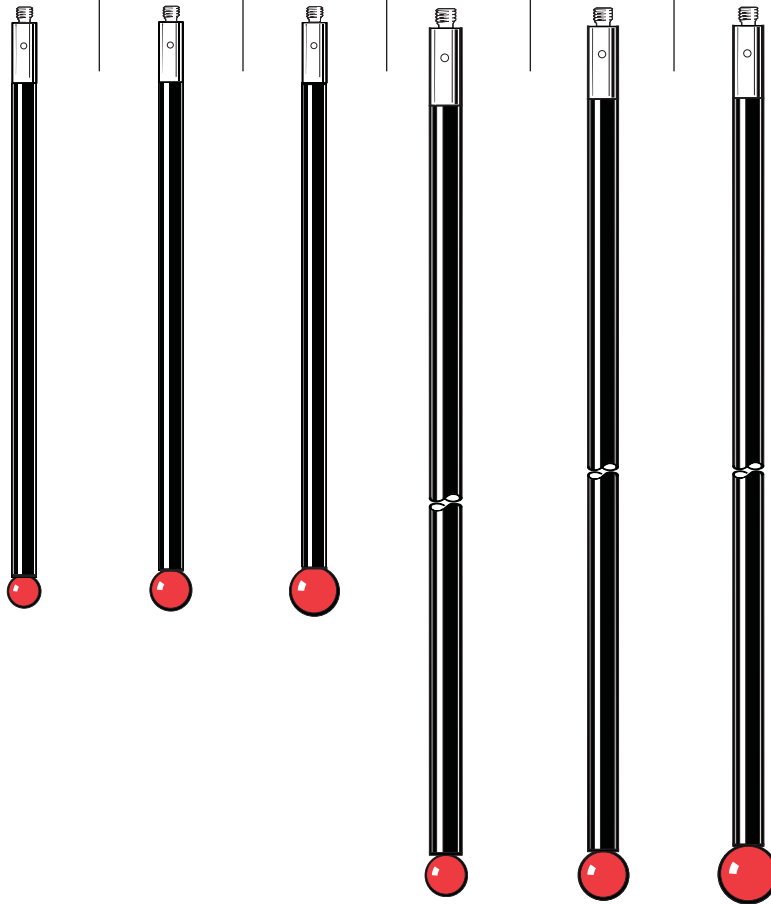

M2 threaded
styli range
3.7

*Effective working length

Recommended REVO styli (stainless steel stem)

Ball material		Part number					
Ruby		A-5000-7806	A-5000-7807	A-5000-3604	A-5000-4154	A-5000-4156	A-5000-4158
Silicon nitride						A-5004-0237	
Zirconia							
A	Ball dia. mm (in.)	1.0 (0.04)	2.0 (0.08)	3.0 (0.12)	4.0 (0.16)	6.0 (0.24)	8.0 (0.32)
B	Length mm (in.)	10.0 (0.40)	10.0 (0.40)	10.0 (0.40)	10.0 (0.40)	10.0 (0.40)	11.0 (0.44)
C	Stem dia. mm (in.)	0.7 (0.028)	1.0 (0.04)	1.5 (0.06)	1.5 (0.06)	2.5 (0.10)	2.5 (0.10)
D	EWL* mm (in.)	4.5 (0.18)	6.0 (0.24)	7.0 (0.28)	10.0 (0.40)	10.0 (0.40)	11.0 (0.44)
	Mass grammes	0.3	0.3	0.4	0.4	0.9	1.5

10 mm range

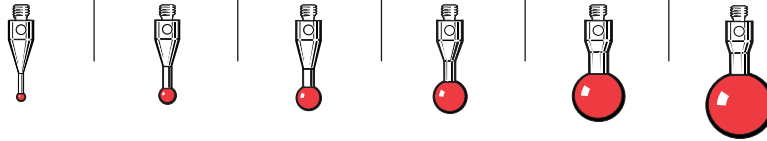

Ball material		Part number		
Ruby		A-5000-3603	A-5000-4160	A-5000-4161
Silicon nitride		A-5003-1730		
Zirconia				
A	Ball dia. mm (in.)	2.0 (0.08)	3.0 (0.12)	4.0 (0.16)
B	Length mm (in.)	20.0 (0.79)	20.0 (0.79)	20.0 (0.79)
C	Stem dia. mm (in.)	1.4 (0.05)	1.5 (0.06)	1.5 (0.06)
D	EWL* mm (in.)	14.0 (0.56)	17.0 (0.67)	20.0 (0.79)
	Mass grammes	0.4	0.5	0.6

20 mm range

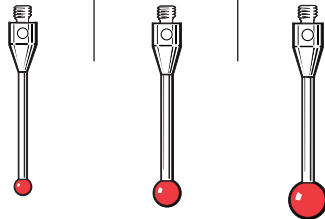

Recommended REVO styli (tungsten carbide stem)

Ball material	Part number					
Ruby	A-5000-7805	A-5003-1345	A-5003-0577	A-5003-0033	A-5000-8663	A-5003-0035
Silicon nitride						
Zirconia						
A Ball dia. mm (in.)	0.5 (0.020)	0.5 (0.020)	0.7 (0.028)	1.0 (0.04)	1.0 (0.04)	1.5 (0.06)
B Length mm (in.)	10.0 (0.40)	20.0 (0.79)	20.0 (0.79)	20.0 (0.79)	27.5 (1.08)	30.0 (1.19)
C Stem dia. mm (in.)	0.4 (0.02)	0.3 (0.012)	0.5 (0.020)	0.8 (0.04)	0.7 (0.028)	1.0 (0.04)
D EWL* mm (in.)	3.0 (0.12)	7.0 (0.28)	12.0 (0.48)	12.5 (0.50)	20.5 (0.81)	22.5 (0.89)
Mass grammes	0.3	0.48	0.32	0.41	0.4	0.58

10 – 30 mm
range

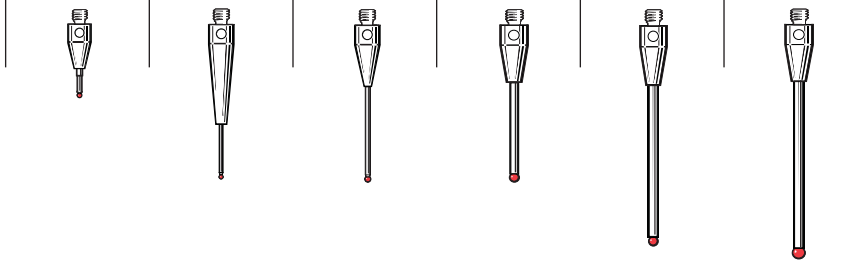

Recommended REVO styli (ceramic stem)

Ball material	Part number		
Ruby	A-5004-3404	A-5003-6985	A-5003-4779
Silicon nitride	A-5004-7273	A-5004-7123	
Zirconia			
A Ball dia. mm (in.)	2.0 (0.08)	2.0 (0.08)	5.0 (0.20)
B Length mm (in.)	30.0 (1.19)	40.0 (1.58)	30.0 (1.19)
C Stem dia. mm (in.)	1.5 (0.06)	1.5 (0.06)	2.5 (0.10)
D EWL* mm (in.)	22.5 (0.89)	32.5 (1.28)	30.0 (1.19)
Mass grammes	0.51	0.58	0.93

30 – 40 mm
range

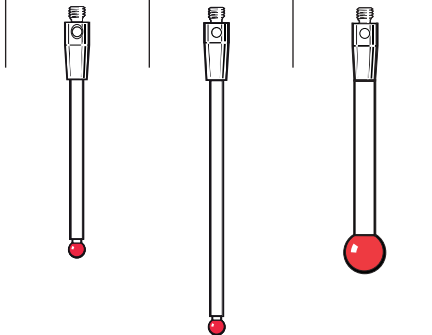

Recommended REVO styli (carbon fibre stem)

Ball material	Part number				
Ruby	A-5003-7852	A-5003-3877	A-5003-9506	A-5003-2285	A-5003-2287
Silicon nitride					
Zirconia					
A Ball dia. mm (in.)	3.0 (0.12)	3.0 (0.12)	3.0 (0.12)	4.0 (0.16)	6.0 (0.24)
B Length mm (in.)	30.0 (1.19)	40.0 (1.58)	50.0 (1.97)	50.0 (1.97)	50.0 (1.97)
C Stem dia. mm (in.)	2.0 (0.08)	2.0 (0.08)	2.0 (0.08)	3.0 (0.12)	3.0 (0.12)
D EWL* mm (in.)	27.5 (1.08)	37.5 (1.48)	47.0 (1.85)	50.0 (1.97)	50.0 (1.97)
Mass grammes	0.45	0.75	0.9	1.0	1.2

30 – 50 mm
range

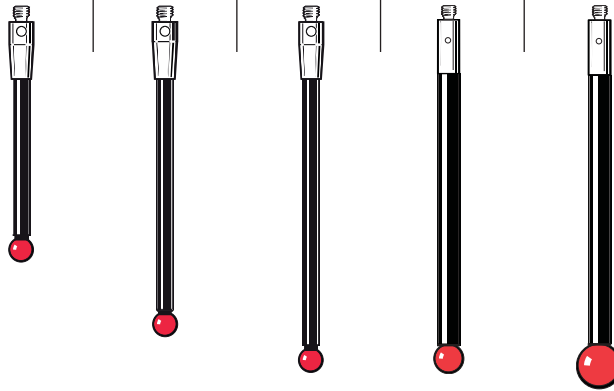



Recommended REVO styli (ceramic hemisphere)

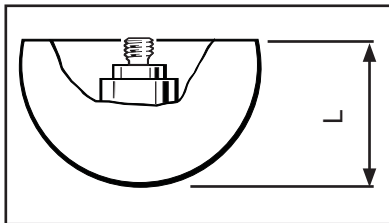
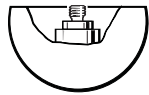



Ball material	Part number
Ceramic	A-5000-3614
A Ball dia. mm (in.)	18.0 (0.71)
B Length mm (in.)	11.0 (0.44)
C Mass grammes	3.3

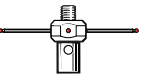
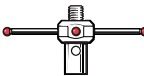
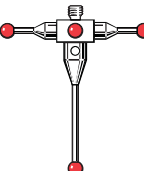
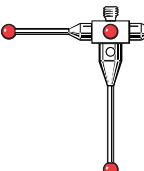

Star styli (fixed)

Part number	A-5003-4011 Tungsten carbide	A-5000-7811 Tungsten carbide	A-5003-4787 Tungsten carbide	A-5003-4788 Tungsten carbide	A-5000-7629 Stainless steel	A-5000-3626 Stainless steel
Span mm (in.)	10.0 (0.40)	10.0 (0.40)	20.0 (0.79)	20.0 (0.79)	18.0 (0.71)	30.0 (1.19)
Ball dia. mm (in.)	0.5 (0.020)	1.0 (0.04)	0.5 (0.020)	1.0 (0.04)	2.0 (0.08)	2.0 (0.08)
Stem dia. mm (in.)	0.3 (0.012)	0.7 (0.028)	0.3 (0.012)	0.7 (0.028)	1.4 (0.05)	1.4 (0.05)
EWL* mm (in.)	N/A	N/A	N/A	N/A	12.0 (0.48)	12.0 (0.48)
Mass grammes	0.7	0.5	0.7	0.9	1.3	1.8
						

Star styli centres

Part number	A-5003-4789 Tungsten carbide	A-5003-4790 Tungsten carbide	A-5003-4791 Tungsten carbide	A-5000-3609 Stainless steel
Ball dia mm (in.)	1.0 (0.04)	0.5 (0.020)	1.0 (0.04)	2.0 (0.08)
Overall length mm (in.)	8.5 (0.33)	18.5 (0.73)	18.5 (0.73)	16.3 (0.64)
Stem dia. mm (in.)	0.7 (0.028)	0.4 (0.02)	0.7 (0.028)	1.4 (0.05)
EWL* mm (in.)	3.5 (0.14)	7.0 (0.28)	11.0 (0.44)	12.0 (0.48)
Mass grammes	0.31	0.43	0.45	0.44
				

Disc styli

Part number	A-5000-3611 Ruby	A-5004-1387 Silver steel	A-5004-1395* Silver steel	A-5004-1396* Silver steel	A-5000-7809* Silver steel
Disc dia mm (in.)	6.0 (0.24)	10.0 (0.40)	12.0 (0.47)	14.0 (0.55)	18.0 (0.71)
Disc depth mm (in.)	1.2 (0.05)	1.2 (0.05)	1.6 (0.06)	1.6 (0.06)	1.5 (0.06)
Roller depth mm (in.)	2.0 (0.08)	2.5 (0.10)	2.5 (0.10)	2.5 (0.10)	2.5 (0.10)
Stem dia. mm (in.)	2.0 (0.08)	2.0 (0.08)	4.2 (0.17)	4.2 (0.17)	4.2 (0.17)
Mass grammes	0.6	1.0	2.0	2.5	3.0

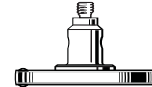

Part number	A-5000-3613 Silver steel	A-5000-7810* Silver steel	A-5000-4187* Silver steel
Disc dia mm (in.)	18.0 (0.71)	25.0 (0.99)	25.0 (0.99)
Disc depth mm (in.)	2.2 (0.09)	1.5 (0.06)	3.0 (0.12)
Roller depth mm (in.)	3.0 (0.12)	2.5 (0.10)	N/A
Stem dia. mm (in.)	N/A	4.2 (0.17)	N/A
Mass grammes	2.7	4.0	3.8

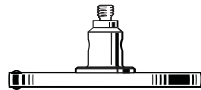

Part number	A-5555-0298 Ceramic	A-5555-0297 Ceramic	A-5555-0299 Ceramic	A-5555-0300 Ceramic
Disc dia mm (in.)	4.0 (0.16)	8.0 (0.32)	14.0 (0.55)	20.0 (0.79)
Disc depth mm (in.)	1.0 (0.04)	1.5 (0.06)	2.0 (0.08)	2.5 (0.10)
Roller depth mm (in.)	N/A	N/A	N/A	N/A
Stem dia. mm (in.)	1.0 (0.04)	1.5 (0.06)	N/A	N/A
Mass grammes	1	1	1	3.8



* M2 stylus can be attached to front face

Cylinder styli

Part number	A-5004-7589 Silver steel	A-5004-7590 Silver steel	A-5000-8876 Ruby	A-5000-8877 Ruby	A-5000-7812 Ruby	A-5003-0073 Ruby
Cylinder dia mm (in.)	1.5 (0.06)	3.0 (0.12)	1.0 (0.04)	1.5 (0.06)	2.0 (0.08)	4.0 (0.16)
Overall length mm (in.)	10.75 (0.42)	12.75 (0.50)	15.0 (0.60)	15.0 (0.60)	20.0 (0.79)	22.0 (0.87)
Stem dia. mm (in.)	1.0 (0.04)	1.5 (0.06)	N/A	N/A	1.6 (0.07)	2.0 (0.08)
EWL* mm (in.)	1.25 (0.05)	3.8 (0.15)	8.0 (0.32)	8.0 (0.32)	7.2 (0.29)	10.0 (0.40)
Mass grammes	0.3	0.6	0.3	0.3	0.5	0.9



*Effective working length

Parallel hemispherical ended styli (tungsten carbide)

Part number	A-5003-1208	A-5003-1210	A-5003-1218	A-5003-1219	A-5003-1228	A-5003-0074	A-5003-1258
Cylinder dia mm (in.)	0.3 (0.012)	0.5 (0.020)	1.0 (0.04)	1.5 (0.06)	2.0 (0.08)	2.0 (0.08)	3.0 (0.12)
Overall length mm (in.)	10.2 (0.41)	15.3 (0.61)	35.5 (1.40)	15.8 (0.63)	16.0 (0.63)	40.0 (1.58)	22.5 (0.89)
EWL* mm (in.)	2.7 (0.11)	7.8 (0.31)	28.0 (1.10)	8.3 (0.33)	8.5 (0.34)	32.0 (1.26)	22.5 (0.89)
Mass grammes	0.3	0.3	0.7	0.6	0.8	2.0	2.0

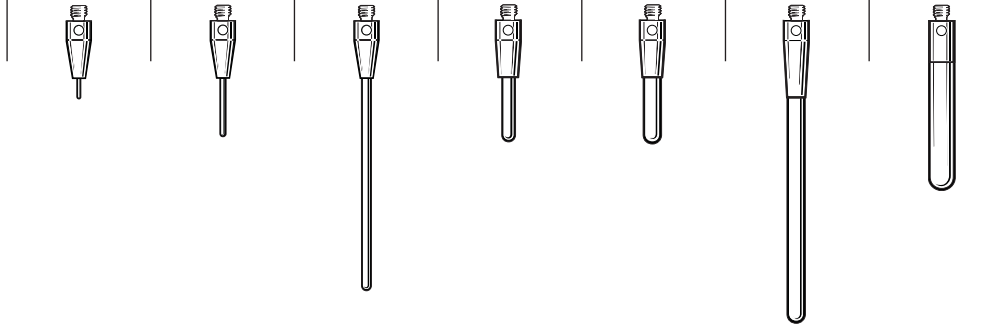

Stylus extensions (stainless steel)

Part number	A-5004-7610	A-5004-7585	A-5004-7586	A-5004-7591	A-5004-7611
Length mm (in.)	5.0 (0.20)	10.0 (0.40)	20.0 (0.79)	30.0 (1.19)	40.0 (1.58)
Stem dia. mm (in.)	3.0 (0.12)	3.0 (0.12)	3.0 (0.12)	3.0 (0.12)	3.0 (0.12)
Mass grammes	0.2	0.4	0.9	1.4	1.8

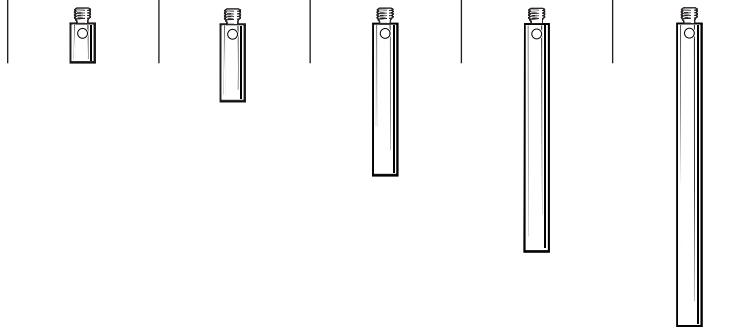

Stylus extensions (ceramic)

Part number	A-5003-0070	A-5003-0071	A-5003-0072
Length mm (in.)	30.0 (1.19)	40.0 (1.58)	50.0 (1.97)
Stem dia. mm (in.)	3.0 (0.12)	3.0 (0.12)	3.0 (0.12)
Mass grammes	0.97	1.22	1.51

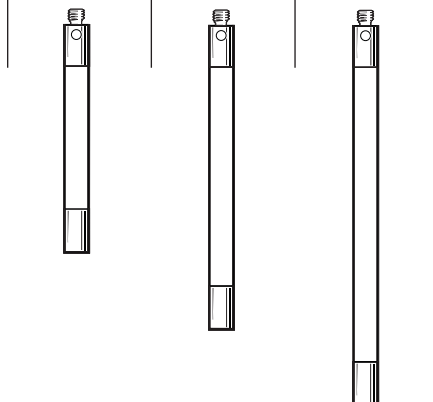

*Effective working length

Stylus extensions (carbon fibre)

Part number	A-5003-2280	A-5003-2281	A-5003-2282	A-5003-2283
Length mm (in.)	40.0 (1.58)	50.0 (1.97)	70.0 (2.76)	90.0 (3.55)
Stem dia. mm (in.)	3.0 (0.12)	3.0 (0.12)	3.0 (0.12)	3.0 (0.12)
Outer dia. mm (in.)	3.5 (0.14)	3.5 (0.14)	3.5 (0.14)	3.5 (0.14)
Mass grammes	0.9	1.0	1.3	1.5

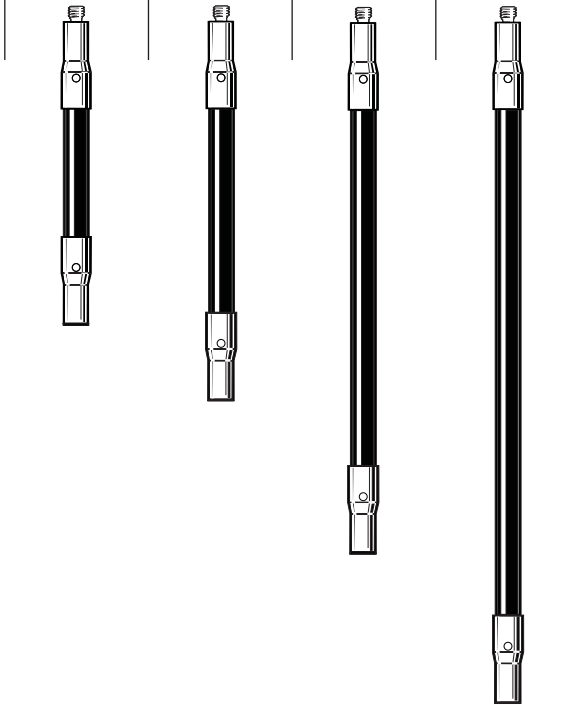

Tightening tool recommended: A-5003-2300

M2 threaded
stylus range

3.15

Special purpose styli

Part number	A-5004-7588 Silver steel	A-5000-7813 Tungsten carbide	A-5000-3614 Ceramic	A-5004-7400 Ceramic
Length mm (in.)	15.0 (0.60)	10.0 (0.40)	11.0 (0.44)	18.0 (0.71)
Ball dia. mm (in.)	N/A	N/A	18.0 (0.71)	30.0 (1.19)
End feature mm (in.)	Flat Rad 0.05 (0.002)	Spherical Rad 0.1 (0.004)	N/A	N/A
Mass grammes	0.7	0.7	3.3	14.5
Angles	30° inclusive	30° inclusive	N/A	N/A

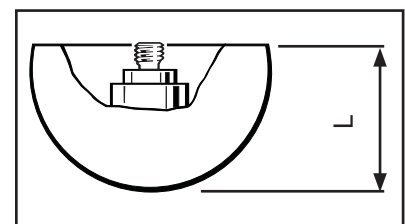

M3 threaded stylus range

4.1













SP25M with two FCR25s on a modular rail system

Renishaw's probing systems are designed to give optimum performance using styli from Renishaw's comprehensive range. The following probes all use M3 threaded styli, however, with suitable adaptors, other thread sizes may be used.

- TP1
- TP6
- REVO®
- SP25M

Ruby ball styli (stainless steel stems)

Ball material		Part number			
Ruby		A-5004-7401	A-5004-0421	A-5004-0422	A-5004-0423
Silicon nitride					
Zirconia					
A	Ball dia. mm (in.)	1.0 (0.04)	2.0 (0.08)	3.0 (0.12)	4.0 (0.16)
B	Length mm (in.)	10.0 (0.40)	10.0 (0.40)	10.0 (0.40)	10.0 (0.40)
C	Stem dia. mm (in.)	0.7 (0.028)	1.5 (0.06)	1.5 (0.06)	2.5 (0.10)
D	EWL* mm (in.)	4.0 (0.16)	6.0 (0.24)	6.5 (0.25)	7.0 (0.28)
	Mass grammes	0.6	0.5	0.5	0.7
					

Ball material		Part number						
Ruby		A-5000-3551	A-5000-3552	A-5000-3553	A-5000-7606	A-5000-7630	A-5000-3554	A-5000-7648
Silicon nitride		A-5004-1979	A-5003-5723	A-5003-6257	A-5003-5061	A-5003-6695	A-5004-1980	A-5004-1981
Zirconia		A-5004-2955	A-5003-5736	A-5004-2956	A-5003-5737	A-5003-9500	A-5004-2957	A-5004-2958
A	Ball dia. mm (in.)	1.0 (0.04)	2.0 (0.08)	3.0 (0.12)	4.0 (0.16)	5.0 (0.20)	4.0 (0.16)	5.0 (0.20)
B	Length mm (in.)	21.0 (0.83)	21.0 (0.83)	21.0 (0.83)	21.0 (0.83)	21.0 (0.83)	31.0 (1.23)	31.0 (1.23)
C	Stem dia. mm (in.)	0.7 (0.028)	1.4 (0.05)	1.5 (0.06)	2.5 (0.10)	2.5 (0.10)	2.5 (0.10)	3.5 (0.14)
D	EWL* mm (in.)	4.0 (0.16)	9.6 (0.38)	14.7 (0.58)	17.2 (0.68)	21.0 (0.83)	27.0 (1.07)	31.0 (1.23)
	Mass grammes	1.0	1.0	1.0	1.3	1.5	2.5	3.0
21 mm – 31 mm range								

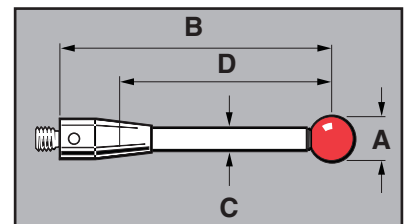

Ruby ball styli (tungsten carbide stems)

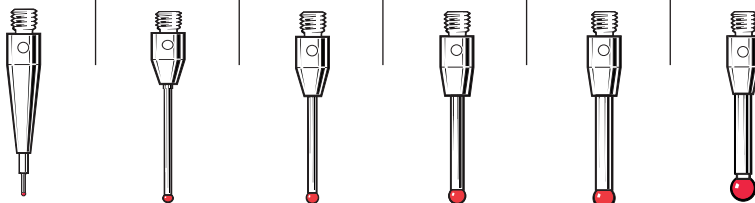
Ball material		Part number					
Ruby		A-5000-7632	A-5004-2442	A-5003-0050	A-5003-3676	A-5003-0054	A-5004-7402
Silicon nitride		A-5004-2023		A-5004-1198		A-5004-1982	
Zirconia		A-5004-2959		A-5004-2960		A-5004-2961	
A	Ball dia. mm (in.)	0.5 (0.020)	1.0 (0.04)	1.5 (0.06)	2.0 (0.08)	2.5 (0.10)	3.0 (0.12)
B	Length mm (in.)	21.0 (0.83)	20.0 (0.79)	20.0 (0.79)	20.0 (0.79)	20.2 (0.80)	20.0 (0.79)
C	Stem dia. mm (in.)	0.4 (0.02)	0.7 (0.028)	1.0 (0.04)	1.5 (0.06)	2.0 (0.08)	2.0 (0.08)
D	EWL* mm (in.)	2.0 (0.08)	12.5 (0.50)	12.5 (0.50)	12.5 (0.50)	12.5 (0.50)	14.0 (0.55)
	Mass grammes	1.0	0.7	0.8	1.1	1.3	1.4
20 mm – 30 mm range							

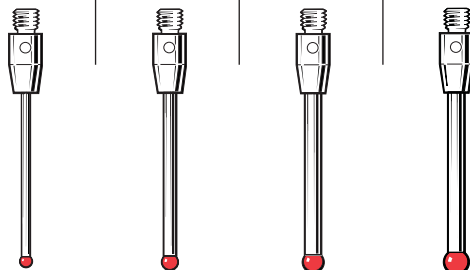
Ball material		Part number			
Ruby		A-5003-0051	A-5003-0052	A-5003-0055	A-5003-0057
Silicon nitride		A-5003-8091	A-5003-5724	A-5004-1983	A-5004-1984
Zirconia		A-5004-2962	A-5003-5738	A-5004-2963	A-5003-6766
A	Ball dia. mm (in.)	1.5 (0.06)	2.0 (0.08)	2.5 (0.10)	3.0 (0.12)
B	Length mm (in.)	30.0 (1.19)	30.0 (1.19)	30.0 (1.19)	30.0 (1.19)
C	Stem dia. mm (in.)	1.0 (0.04)	1.5 (0.06)	2.0 (0.08)	2.0 (0.08)
D	EWL* mm (in.)	22.5 (0.89)	22.8 (0.90)	22.5 (0.89)	24.0 (0.94)
	Mass grammes	0.93	1.32	1.81	1.83
20 mm – 30 mm range					

Ruby ball styli (tungsten carbide stems)

Ball material		Part number							
Ruby		A-5003-0053	A-5003-0056	A-5003-0058	A-5003-0060	A-5003-0062	A-5003-0059	A-5003-0061	A-5003-0063
Silicon nitride		A-5004-1985	A-5004-1986	A-5004-1987	A-5004-1195	A-5004-1718	A-5004-1199	A-5004-1988	A-5004-1201
Zirconia		A-5003-2043	A-5004-2964	A-5004-2965	A-5003-6767	A-5004-2966	A-5004-2968	A-5003-6768	A-5003-7665
A	Ball dia. mm (in.)	2.0 (0.08)	2.5 (0.10)	3.0 (0.12)	4.0 (0.16)	5.0 (0.20)	3.0 (0.12)	4.0 (0.16)	5.0 (0.20)
B	Length mm (in.)	40.0 (1.58)	40.0 (1.58)	40.0 (1.58)	40.0 (1.58)	40.0 (1.58)	50.0 (1.97)	50.0 (1.97)	50.0 (1.97)
C	Stem dia. mm (in.)	1.5 (0.06)	2.0 (0.08)	2.0 (0.08)	2.0 (0.08)	2.5 (0.10)	2.0 (0.08)	2.0 (0.08)	2.5 (0.10)
D	EWL* mm (in.)	32.5 (1.28)	32.5 (1.28)	33.7 (1.33)	36.0 (1.42)	40.0 (1.58)	43.7 (1.72)	46.0 (1.82)	50.0 (1.97)
	Mass grammes	1.58	2.28	2.30	2.38	3.50	2.78	2.85	4.10

40 mm – 50 mm range

Ruby ball styli (ceramic stems)

Ball material		Part number							
Ruby		A-5004-3646	A-5004-2545	A-5004-6040	A-5004-0154	A-5004-6735	A-5003-0067	A-5003-0068	A-5003-0069
Silicon nitride							A-5004-1989	A-5003-5725	A-5004-1990
Zirconia							A-5004-2969	A-5003-5739	A-5004-2970
A	Ball dia. mm (in.)	2.0 (0.08)	2.5 (0.10)	3.0 (0.12)	4.0 (0.16)	5.0 (0.20)	3.0 (0.12)	4.0 (0.16)	5.0 (0.20)
B	Length mm (in.)	40.0 (1.58)	40.0 (1.58)	40.0 (1.58)	40.0 (1.58)	40.0 (1.58)	50.0 (1.97)	50.0 (1.97)	50.0 (1.97)
C	Stem dia. mm (in.)	1.5 (0.06)	2.0 (0.08)	2.0 (0.08)	2.0 (0.08)	2.5 (0.10)	2.0 (0.08)	2.0 (0.08)	2.5 (0.10)
D	EWL* mm (in.)	32.5 (1.28)	32.5 (1.28)	32.5 (1.28)	36.0 (1.42)	40.0 (1.58)	43.7 (1.72)	46.0 (1.82)	50.0 (1.97)
	Mass grammes	0.9	1.1	1.1	1.2	1.7	1.17	1.24	1.33

50 mm range

*Effective working length

Ruby ball styli (carbon fibre stems)

Ball material	Part number				
Ruby	A-5003-4860	A-5003-4862	A-5003-4861	A-5003-4863	
Silicon nitride	A-5003-5726	A-5004-1991	A-5003-5727	A-5004-5466	
Zirconia	A-5003-5740	A-5003-6771	A-5003-5741	A-5003-6778	
A	Ball dia. mm (in.)	6.0 (0.24)	8.0 (0.32)	6.0 (0.24)	8.0 (0.32)
B	Length mm (in.)	75.0 (2.96)	75.0 (2.96)	100.0 (3.94)	100.0 (3.94)
C	Stem dia. mm (in.)	4.0 (0.16)	4.0 (0.16)	4.0 (0.16)	4.0 (0.16)
D	EWL* mm (in.)	75.0 (2.96)	75.0 (2.96)	100.0 (3.94)	100.0 (3.94)
	Mass grammes	2.40	2.98	2.89	3.47

75 mm –
100 mm range

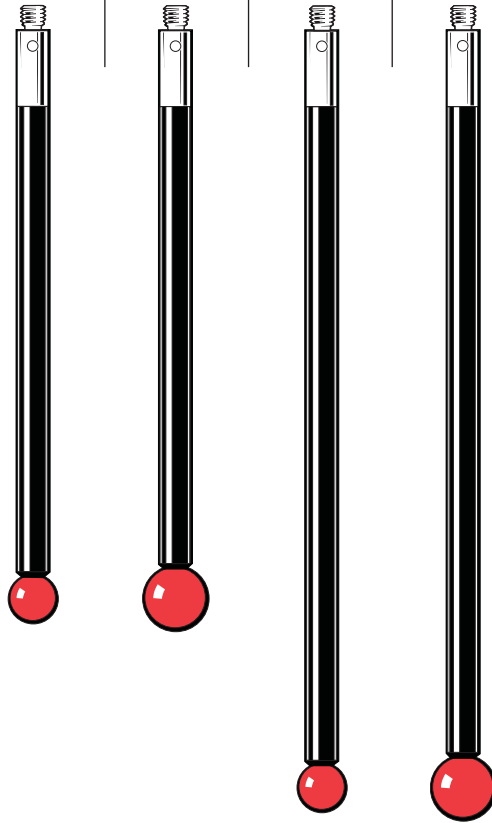

M3 threaded
stylus range

4.5

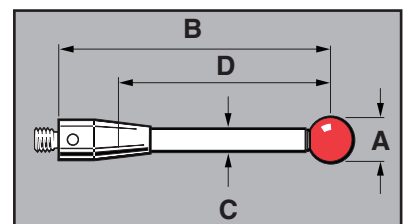

Ruby ball styli (carbon fibre stems)

M3 threaded
stylus range

4.6

Ball material		Part number						
Ruby		A-5003-7057	A-5003-7056	A-5003-7055	A-5003-7054	A-5003-7445	A-5003-7446	A-5003-7447
Silicon nitride		A-5004-1992	A-5004-1993	A-5004-1994	A-5004-1995	A-5004-1996**	A-5004-1997**	A-5004-1998**
Zirconia		A-5004-2972	A-5003-9495	A-5004-2973	A-5004-2974	A-5004-2975**	A-5004-2976**	A-5004-2977**
A	Ball dia. mm (in.)	10.0 (0.40)	10.0 (0.40)	10.0 (0.40)	10.0 (0.40)	12.0 (0.48)	12.0 (0.48)	12.0 (0.48)
B	Length mm (in.)	75.0 (2.96)	100.0 (3.94)	150.0 (5.91)	200.0 (7.88)	100.0 (3.94)	150.0 (5.91)	200.0 (7.88)
C	Stem dia. mm (in.)	4.0 (0.16)	4.0 (0.16)	4.0 (0.16)	4.0 (0.16)	4.0 (0.16)	4.0 (0.16)	4.0 (0.16)
D	EWL* mm (in.)	75.0 (2.96)	100.0 (3.94)	150.0 (5.91)	200.0 (7.88)	100.0 (3.94)	150.0 (5.91)	200.0 (7.88)
	Mass grammes	4.05	4.53	5.49	6.47	5.9	6.9	7.9

75 mm – 200 mm
range

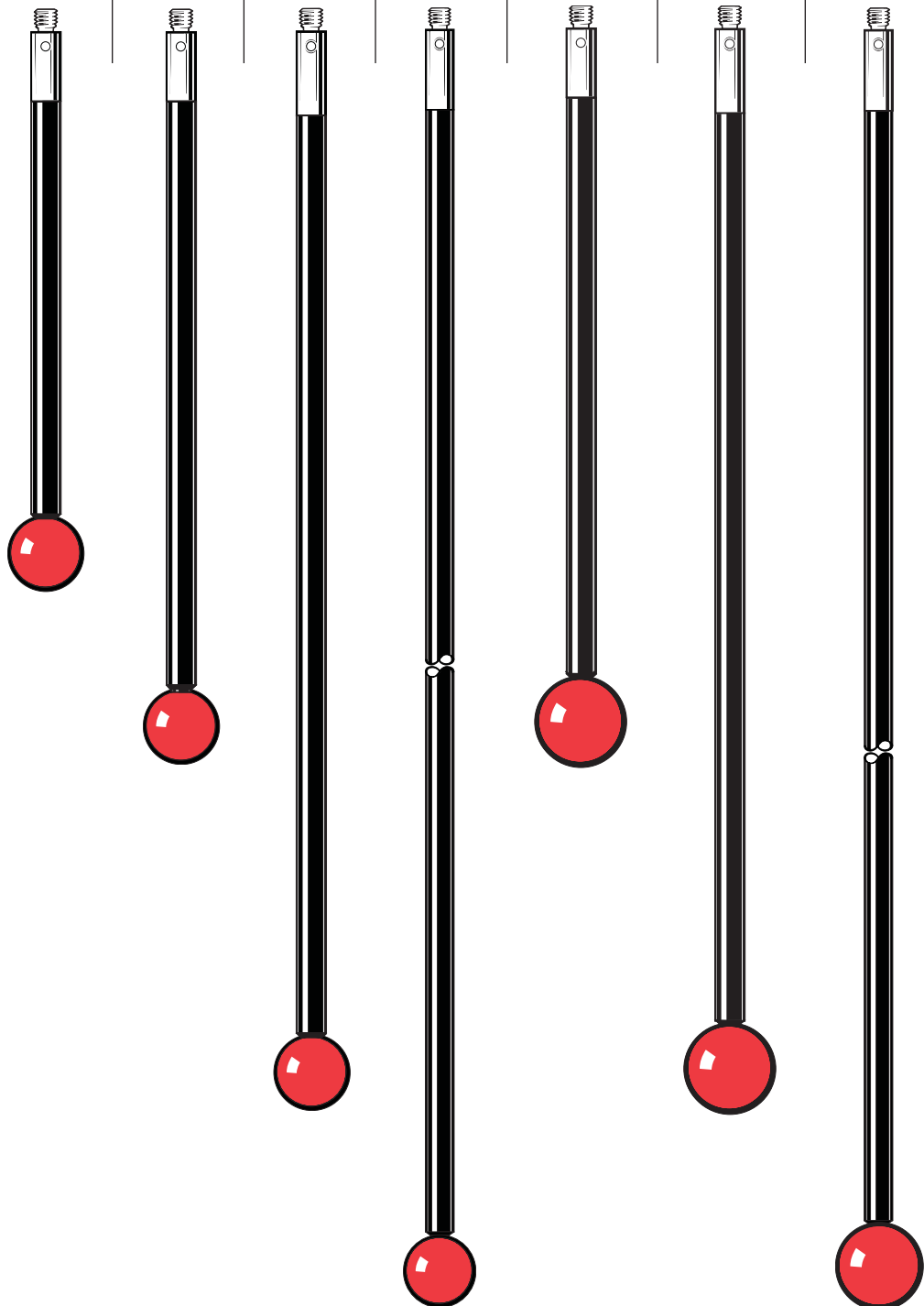

* Effective working length

** Specials

Stylus extensions (stainless steel)

Part number	A-5004-7609	A-5004-7583	A-5004-7584
Length mm (in.)	10.0 (0.40)	20.0 (0.79)	35.0 (1.38)
Stem dia. mm (in.)	4.0 (0.16)	4.0 (0.16)	4.0 (0.16)
Mass grammes	0.9	1.6	2.9



Stylus extension (ceramic)

Part number	A-5003-0075
Length mm (in.)	50.0 (1.97)
Stem dia. mm (in.)	4.0 (0.16)
Mass grammes	2.95



Stylus extensions (carbon fibre)

Part number	A-5003-4864	A-5003-4865
Length mm (in.)	75.0 (2.96)	100.0 (3.94)
Stem dia. mm (in.)	4.5 (0.17)	4.5 (0.17)
Mass grammes	2.53	3.02



Disc and hollow ball styli

Part number	A-5000-3615 Silver steel	A-5000-7612 Silver steel	A-5000-7669 Carbon steel
Disc dia mm (in.)	12.7 (0.50)	35.0 (1.38)	63.5 (2.51)
Disc depth mm (in.)	2.2 (0.09)	5.0 (0.20)	6.0 (0.24)
Stem dia. mm (in.)	3.5 (0.14)	N/A	N/A
Mass grammes	4.0	10.0	45.0

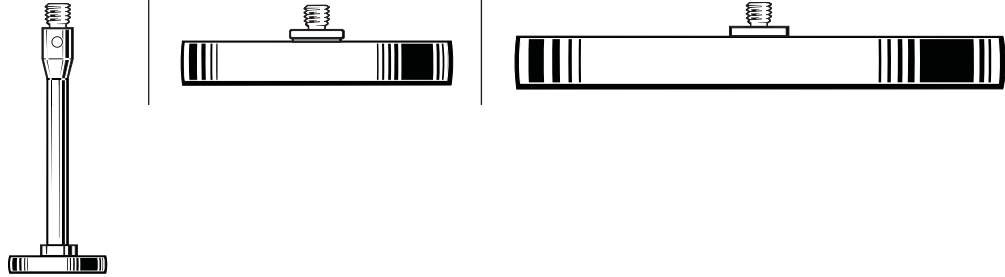

Part number	A-5004-3728 Ceramic	A-5000-7814 Ceramic	A-5003-7098 Ceramic
Disc dia mm (in.)	18.0 (0.71)	30.0 (1.19)	30.0 (1.19)
Disc depth mm (in.)	12.0 (0.48)	17.0 (0.67)	1.5 (0.06)
Stem dia. mm (in.)	N/A	N/A	4.0 (0.16)
Mass grammes	4	13.0	3.6

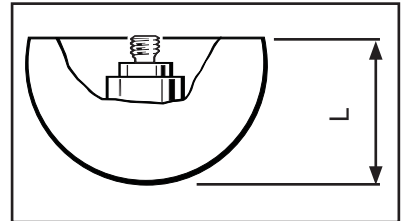
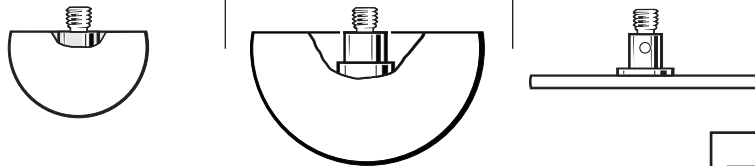

Star styli (fixed)

Part number	A-5003-0076 Stainless steel	A-5003-0077 Stainless steel
Span mm (in.)	30.0 (1.19)	50.0 (1.97)
Ball mm (in.)	2.0 (0.08)	2.0 (0.08)
Stem dia. mm (in.)	1.4 (0.05)	1.4 (0.05)
EWL* mm (in.)	11.0 (0.44)	11.0 (0.44)
Mass grammes	2.38	5.25

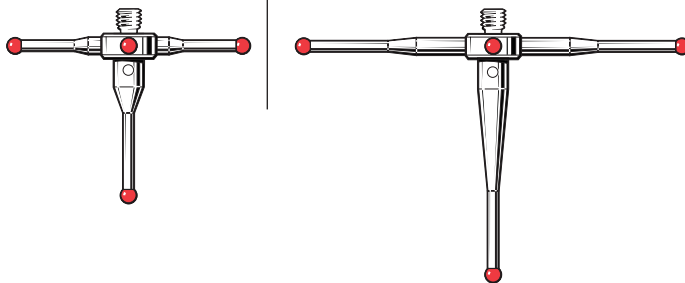

*Effective working length

M4 threaded stylus range



The OSP60 is a high-speed optical 3D scanning probe for machining centres

Renishaw's probing systems are designed to give optimum performance using styli from Renishaw's comprehensive range. The following probes all use M4 threaded styli, however, with suitable adaptors, other thread sizes may be used.

CMM

- TP1
- TP7
- SP600

Machine tool

- MP11
- LP2
- TS27R
- OMP40-2
- OMP400
- RMP60
- RP3
- RMP40
- RLP40
- OLP40
- OMP60
- OTS
- RMP600
- MP250
- HPRA
- HPPA
- HPMa
- OSP60
- PRIMO

Ruby ball styli (stainless steel stems)

Ball material	Part number				
Ruby	A-5000-6350	A-5000-7545	A-5000-7547	A-5000-7549	A-5000-7551
Silicon nitride			A-5003-5728		A-5003-5729
Zirconia			A-5003-5742		A-5003-5743
A Ball dia. mm (in.)	5.0 (0.20)	1.0 (0.04)	2.0 (0.08)	3.0 (0.12)	4.0 (0.16)
B Length mm (in.)	10.0 (0.40)	19.5 (0.77)	19.0 (0.75)	18.5 (0.73)	18.0 (0.71)
C Stem dia. mm (in.)	3.0 (0.12)	0.7 (0.028)	1.4 (0.05)	2.0 (0.08)	3.0 (0.12)
D EWL* mm (in.)	5.0 (0.20)	4.5 (0.18)	9.2 (0.36)	13.0 (0.52)	13.7 (0.54)
Mass grammes	1.9	2.5	2.3	2.0	2.1

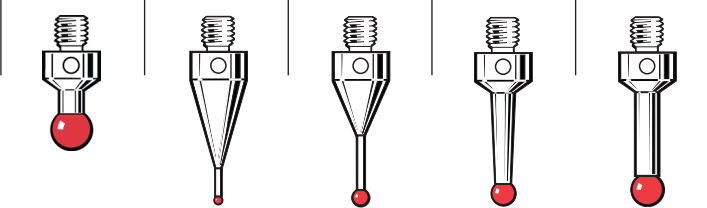

Part number	A-5000-7553	A-5000-6731	A-5000-6352	A-5000-7555	A-5000-7557
A Ball dia. mm (in.)	5.0 (0.20)	5.0 (0.20)	5.0 (0.20)	6.0 (0.24)	8.0 (0.32)
B Length mm (in.)	17.5 (0.69)	20.0 (0.79)	30.0 (1.19)	17.0 (0.67)	16.0 (0.63)
C Stem dia. mm (in.)	3.5 (0.14)	3.0 (0.12)	3.0 (0.12)	4.5 (0.18)	6.0 (0.24)
D EWL* mm (in.)	13.6 (0.55)	15.89 (0.63)	26.0 (1.03)	13.3 (0.53)	16.0 (0.63)
Mass grammes	2.3	2.4	3.0	3.0	3.9

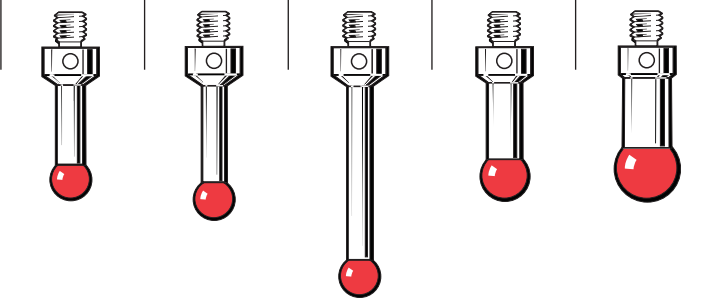

10 mm – 30 mm range

Ruby ball styli (Tungsten carbide stems)

Part number	A-5003-4792	A-5003-2932	A-5003-4793	A-5003-4794	A-5003-4795	A-5003-4796
A Ball dia. mm (in.)	1.0 (0.04)	2.0 (0.08)	3.0 (0.12)	4.0 (0.16)	5.0 (0.20)	6.0 (0.24)
B Length mm (in.)	20.0 (0.79)	20.0 (0.79)	20.0 (0.79)	20.0 (0.79)	20.0 (0.79)	20.0 (0.79)
C Stem dia. mm (in.)	0.7 (0.028)	1.5 (0.06)	2.0 (0.08)	2.0 (0.08)	2.5 (0.10)	2.5 (0.10)
D EWL* mm (in.)	10.0 (0.40)	10.0 (0.40)	8.5 (0.33)	8.5 (0.33)	7.9 (0.31)	10.7 (0.42)
Mass grammes	2.39	3.01	3.53	3.53	4.52	4.66

20 mm range

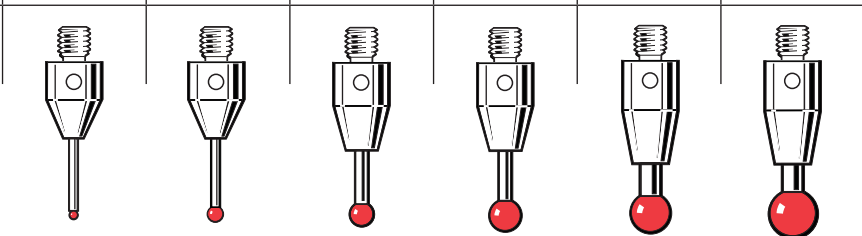
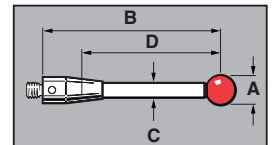



Ruby ball styli

Ceramic stems

Part number		A-5003-0233	A-5003-0235	A-5000-3709	A-5000-7795	A-5003-0236	A-5003-2764	A-5003-4802
		Ceramic	Ceramic	Ceramic	Ceramic	Ceramic	Ceramic	Ceramic
A	Ball dia. mm (in.)	4.0 (0.16)	5.0 (0.20)	6.0 (0.24)	8.0 (0.32)	5.0 (0.20)	6.0 (0.24)	8.0 (0.32)
B	Length mm (in.)	50.0 (1.97)	50.0 (1.97)	50.0 (1.97)	50.0 (1.97)	75.0 (2.96)	75.0 (2.96)	75.0 (2.96)
C	Stem dia. mm (in.)	3.0 (0.12)	3.8 (0.15)	4.5 (0.18)	4.5 (0.18)	3.8 (0.15)	4.5 (0.18)	4.5 (0.18)
D	EWL* mm (in.)	33.5 (1.32)	33.5 (1.32)	38.5 (1.50)	50.0 (1.97)	58.5 (2.30)	63.5 (2.51)	75.0 (2.96)
	Mass grammes	3.9	5.0	4.8	5.4	5.63	5.64	6.20

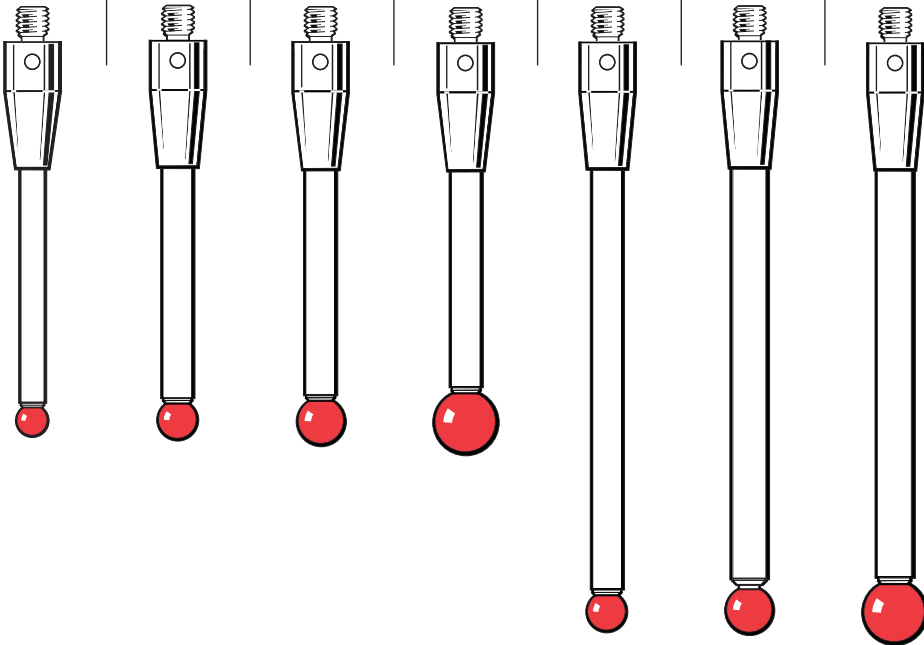
50 mm – 75 mm range



M4 threaded
stylus range

5.3

Tungsten carbide stems

Part number		A-5003-4797	A-5003-3680	A-5003-4799	A-5003-4800	A-5003-4801
		Tungsten carbide	Tungsten carbide	Tungsten carbide	Tungsten carbide	Tungsten carbide
A	Ball dia. mm (in.)	2.0 (0.08)	3.0 (0.12)	4.0 (0.16)	5.0 (0.20)	6.0 (0.24)
B	Length mm (in.)	50.0 (1.97)	50.0 (1.97)	50.0 (1.97)	50.0 (1.97)	50.0 (1.97)
C	Stem dia. mm (in.)	1.5 (0.06)	2.0 (0.08)	2.0 (0.08)	2.5 (0.10)	2.5 (0.10)
D	EWL* mm (in.)	40.0 (1.58)	38.5 (1.51)	38.5 (1.51)	37.9 (1.49)	40.7 (1.60)
	Mass grammes	3.80	4.94	4.99	6.72	6.86

50 mm range

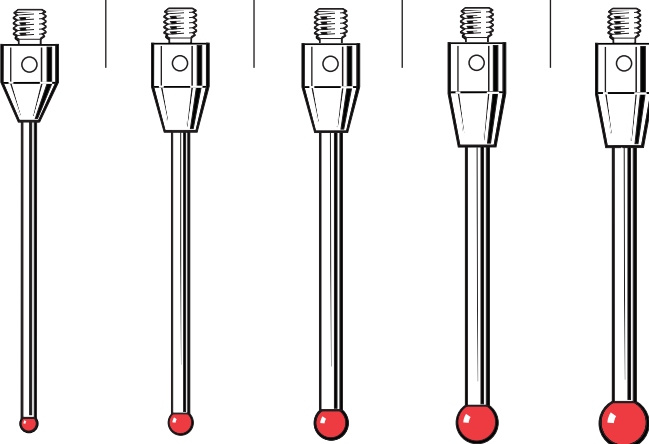

Stainless steel stems

Part number		A-5000-7521
		Stainless steel
A	Ball dia. mm (in.)	5.0 (0.20)
B	Length mm (in.)	50.0 (1.97)
C	Stem dia. mm (in.)	4.5 (0.18)
D	EWL* mm (in.)	33.5 (1.32)
	Mass grammes	5.8

50 mm range



*Effective working length

Ruby ball styli

M4 threaded
stylus range

5.4

Part number	A-5000-7522 Stainless steel	A-5000-9761 Ceramic	A-5000-7523 Stainless steel	A-5000-3712 Ceramic	A-5000-8156 Ceramic	A-5000-7796 Ceramic	A-5003-3461 Carbon fibre
A Ball dia. mm (in.)	5.0 (0.20)	5.0 (0.20)	5.0 (0.20)	6.0 (0.24)	6.0 (0.24)	8.0 (0.32)	8.0 (0.32)
B Length mm (in.)	100.0 (3.94)	100.0 (3.94)	150.0 (5.91)	100.0 (3.94)	150.0 (5.91)	100.0 (3.94)	300.0 (11.82)
C Stem dia. mm (in.)	4.5 (0.18)	3.8 (0.15)	4.4 (0.17)	4.5 (0.18)	4.5 (0.18)	4.5 (0.18)	4.5 (0.18)
D EWL* mm (in.)	83.2 (3.28)	83.5 (3.29)	133.0 (5.24)	88.5 (3.48)	135.0 (5.31)	100.0 (3.94)	300.0 (11.82)
Mass grammes	11.3	6.3	17.4	6.3	7.9	7.5	10.4

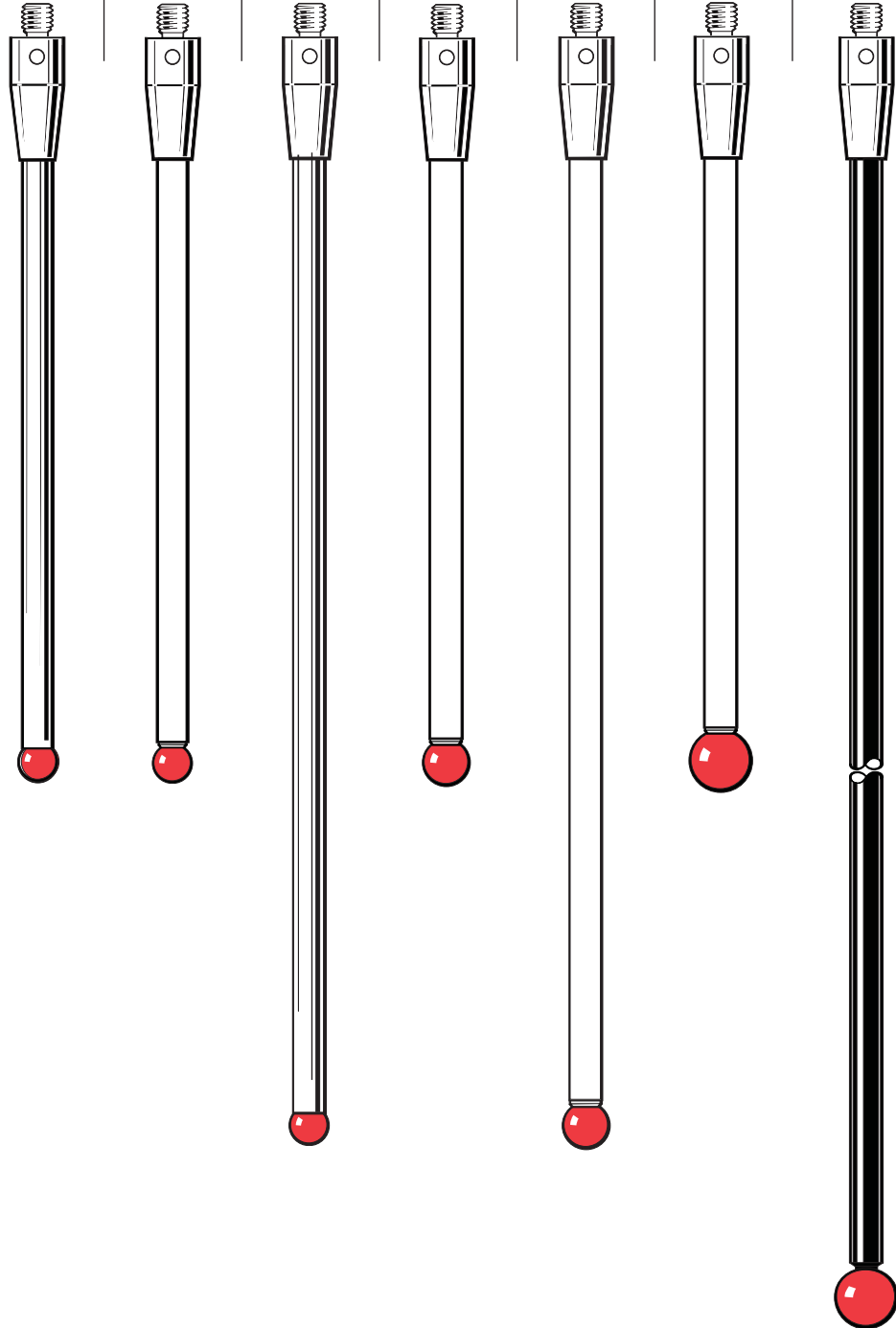

100 mm – 300 mm range

Ruby ball styli
(recommended for use with
OMP400 and RMP600)

Ball material	Part number			
Ruby	A-5003-7306	A-5003-6510	A-5003-6511	A-5003-6512
Silicon nitride	A-5003-5730	A-5003-5731		
Zirconia	A-5003-5744	A-5003-5745		
	Carbon fibre	Carbon fibre	Carbon fibre	Carbon fibre
A Ball dia. mm (in.)	6.0 (0.24)	6.0 (0.24)	6.0 (0.24)	6.0 (0.24)
B Length mm (in.)	50.0 (1.97)	100.0 (3.94)	150.0 (5.91)	200.0 (7.88)
C Stem dia. mm (in.)	4.5 (0.18)	4.5 (0.18)	4.5 (0.18)	4.5 (0.18)
D EWL* mm (in.)	38.5 (1.52)	88.5 (3.48)	138.5 (5.45)	188.5 (7.42)
Mass grammes	4.1	6.2	7.5	8.7

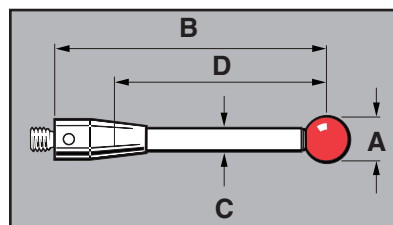
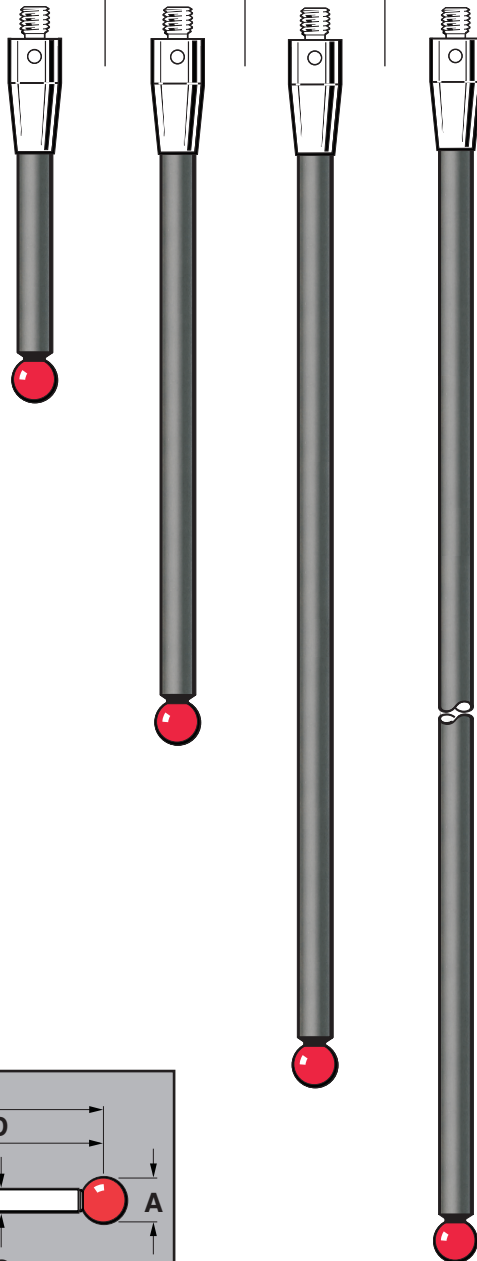

*Effective working length

Ruby ball styli
(recommended for use with MP700)

A-5003-1436**	A-5003-1358**	A-5003-1255**	A-5003-1075**
Carbon fibre	Carbon fibre	Carbon fibre	Carbon fibre
6.0 (0.24)	6.0 (0.24)	6.0 (0.24)	6.0 (0.24)
50.0 (1.97)	100.0 (3.94)	150.0 (5.91)	200.0 (7.88)
4.5 (0.18)	4.5 (0.18)	4.5 (0.18)	4.5 (0.18)
38.5 (1.52)	88.5 (3.48)	138.5 (5.46)	188.5 (7.42)
4.1	6.2	7.5	8.7

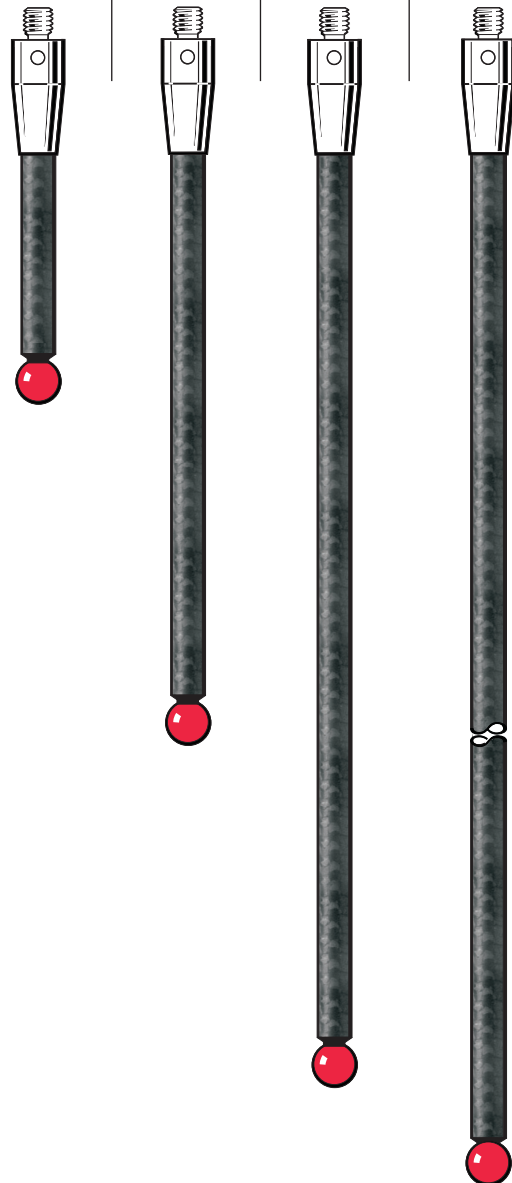

** This MP700 specific stylus has an additional internal design feature that in case of severe overtravel crash allows for a controlled reseating of the probe kinematics avoiding strain gauge damage.

M4 star styli

Ball material	Part number	
Ruby	A-5000-6462	A-5000-7098
A Ball dia. mm (in.)	6.0 (0.24)	6.0 (0.24)
B Length mm (in.)	100.0 (3.94)	50.0 (1.97)
C Stem dia. mm (in.)	4.5 (0.18)	4.5 (0.18)
D EWL* mm (in.)	88.5 (3.48)	38.5 (1.52)
Mass grammes	7.5	6.0

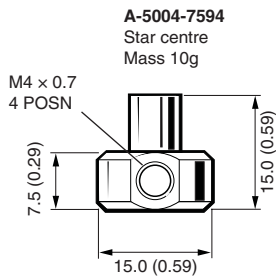
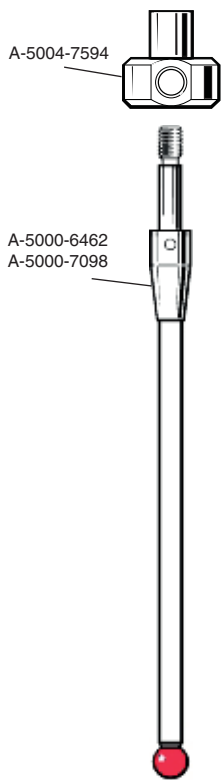

Disc styli

Part number	A-5000-7596	A-5000-7597	A-5000-7598
Diameter A mm (in.)	Ø30.0 (1.19)	Ø35.0 (1.38)	Ø50.0 (1.97)
Diameter B mm (in.)	Ø21.0 (0.83)	Ø21.0 (0.83)	Ø23.0 (0.91)
C mm (in.)	2.2 (0.09)	2.2 (0.09)	3.0 (0.12)
D mm (in.)	3.0 (0.12)	3.0 (0.12)	4.0 (0.16)
Mass grammes	8.01	9.57	13.55

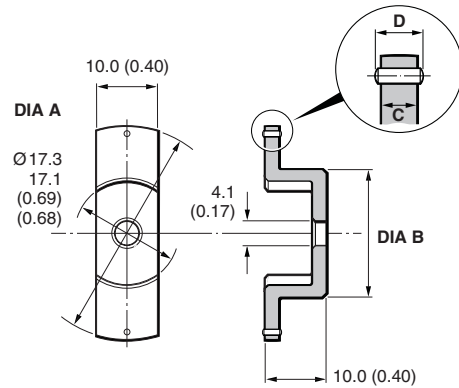

Part number	A-5000-6351
	Silver steel
Disc dia. mm (in.)	Ø30.0 (1.19)
Disc depth mm (in.)	3.0 (0.12)
Length mm (in.)	10.0 (0.40)
Rollers	N/A
Mass grammes	7.9

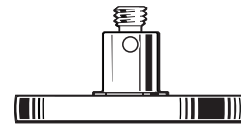

Swivel adaptor

Part number	A-5004-7607	A-5004-7608
Length A mm (in.)	10.0 (0.40)	13.5 (0.54)
Length B mm (in.)	12.5 (0.50)	16.0 (0.63)
Mass grammes	2.76	3.70

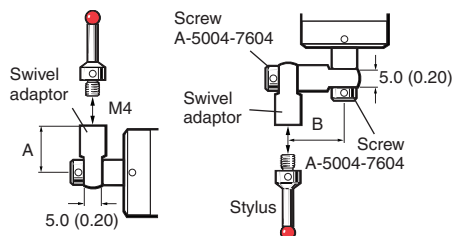

Styli crank

Part number	A-5004-7605	A-5004-7606
Length A mm (in.)	21.9 (0.86)	27.6 (1.09)
Mass grammes	6.07	6.94

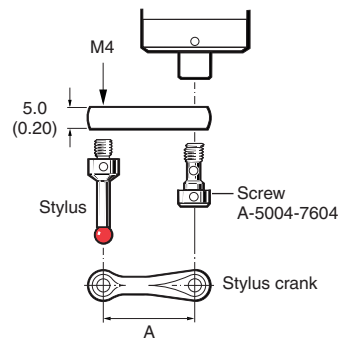

*Effective working length

OSP60 styli – M4 thread (ceramic stems)

Part number (standard)	A-5004-4472	A-5004-4474	A-5004-6470	A-5004-6471
Part number (calibrated)	A-5465-8576	A-5465-8577	A-5465-5008	A-5465-5009
Ball material	Ruby	Ruby	Silicon nitride	Silicon nitride
A Ball dia. mm (in.)	6.0 (0.24)	6.0 (0.24)	6.0 (0.24)	6.0 (0.24)
B Length mm (in.)	100.0 (3.94)	150.0 (5.91)	100.0 (3.94)	150.0 (5.91)
C Stem dia. mm (in.)	3.8 (0.15)	3.8 (0.15)	3.8 (0.15)	3.8 (0.15)
D ESWL* mm (in.)	62.9 (2.48)	71.5 (2.81)	62.9 (2.48)	71.5 (2.81)
Mass grammes	6.5	8.0	6.5	8.0

* ESWL = Effective Scanning Working Length, measured from the centre of the ball to the point at which the stem will foul against a vertical face when at the maximum scanning deflection.

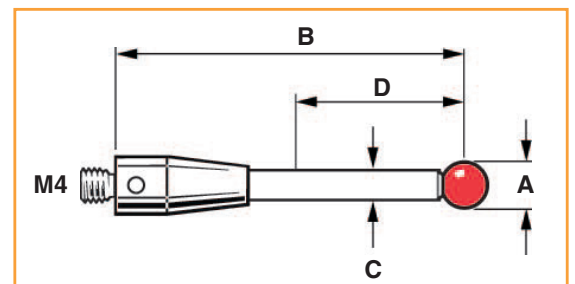
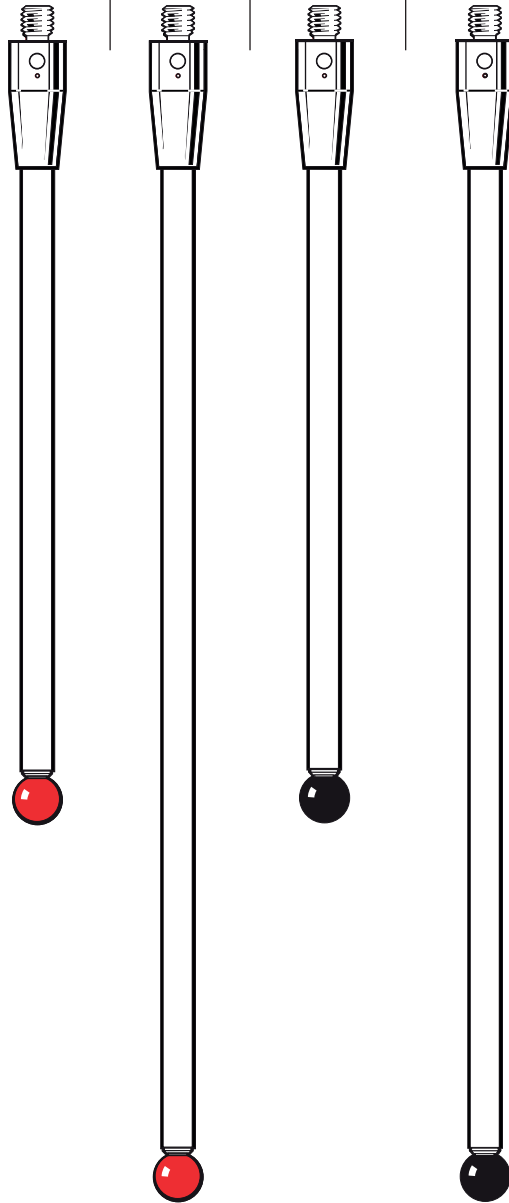

M4 threaded
 stylus range
5.7

OSP60 styli continued
M4 thread (ceramic stems)

Part number (standard)	A-5004-6463	A-5004-6464	A-5004-6465	A-5004-6467	A-5004-6468	A-5004-6469
Part number (calibrated)	A-5465-5001	A-5465-5002	A-5465-5003	A-5465-5005	A-5465-5006	A-5465-5007
Ball material	Ruby	Ruby	Ruby	Silicon nitride	Silicon nitride	Silicon nitride
A Ball diameter mm (inch)	2.0 (0.08)	3.0 (0.12)	4.0 (0.16)	2.0 (0.08)	3.0 (0.12)	4.0 (0.16)
B Length mm (inch)	80.0 (3.15)	100.0 (3.94)	100.0 (3.94)	80.0 (3.15)	100.0 (3.94)	100.0 (3.94)
C Stem diameter mm (inch)	1.5 (0.06)	2.0 (0.08)	2.0 (0.08)	1.5 (0.06)	2.0 (0.08)	2.0 (0.08)
D ESWL* mm (inch)	10.7 (0.42)	27.0 (1.06)	42.6 (1.68)	10.7 (0.42)	27.0 (1.06)	42.6 (1.68)
E Stem diameter mm (inch)	3.8 (0.15)	3.8 (0.15)	3.8 (0.15)	3.8 (0.15)	3.8 (0.15)	3.8 (0.15)
Mass (grammes)	5.9	7.4	7.4	5.9	7.4	7.4

* ESWL = Effective Scanning Working Length, measured from the centre of the ball to the point at which the stem will foul against a vertical face when at the maximum scanning deflection.

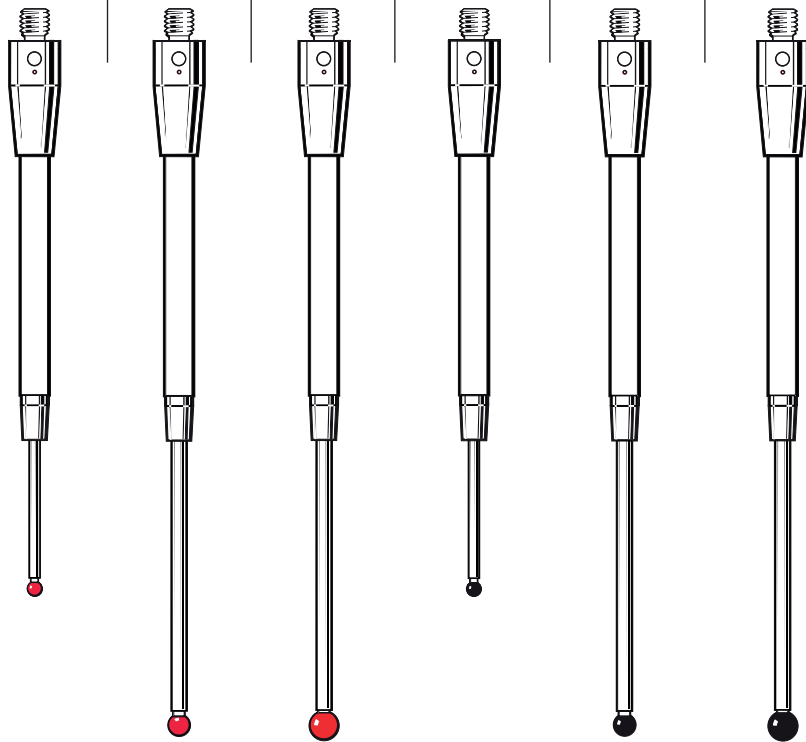

OSP60 standard range

During scanning the stylus is constantly deflected, so the ceramic stem has been designed to be narrow and therefore tightly control all squareness tolerances. This ensures that even when measuring a part with vertical surfaces, such as on prismatic parts, the risk of the stylus shank contacting the part before the stylus tip is minimised.

OSP60 calibrated range

In the variable temperature environment typical of a machine tool, the dimensional variation of the calibration sphere, compared with the machine structure, can degrade the performance of the measurement system. In the highest accuracy applications, this contribution to the overall system measurement uncertainty can be significant.

To ensure the highest possible measurement accuracy in all measurement conditions, the ball on each stylus within the OSP60 calibrated range is measured and UKAS certified. The exact ball diameter is engraved onto the stylus holder, so that this highly accurate value can be applied during probe calibration as an absolute reference.

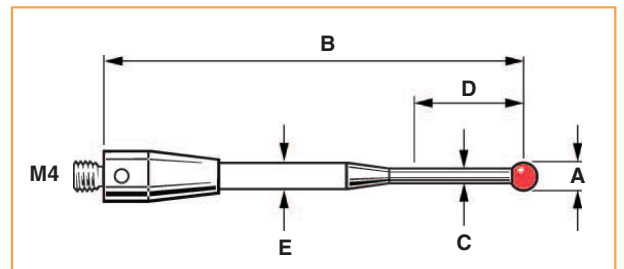
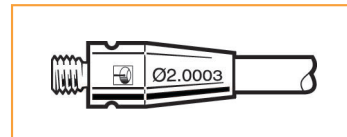

Primo toolsetter stylus

Part number	A-5472-3000	
	Tungsten carbide	
Ruby		
Silicon nitride		
Zirconia		
A	Disc dia. mm (in.)	26 (1.02)
B	Disc depth mm (in.)	4 (0.16)
C	Length A mm (in.)	11 (0.43)
D	Length B mm (in.)	31 (1.22)
	Mass grammes	34

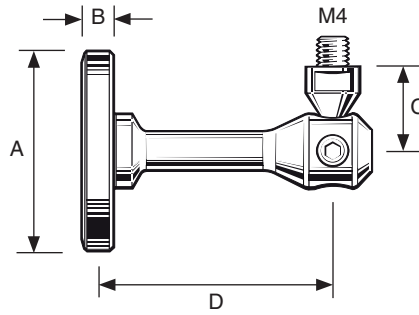

Flat bottom cylinder stylus (tungsten carbide)

Part number	A-5004-5370 Tungsten carbide
Cylinder dia. mm (in.)	1.0 (0.04)
Overall length mm (in.)	20.0 (0.79)
EWL mm (in.)	10.0 (0.40)
Mass grammes	2.5



This flat-bottomed stylus has been specifically designed for xy and accurate z point measurement with the face being precision ground parallel.

Crash protection devices

Part number For pack of ten	A-5004-7598	A-5004-7603	A-5004-7604	A-5004-7621	A-5003-0661* A-5004-1865	A-5004-7624 A-5004-1867	A-5004-6723 A-5004-1869
	Stainless steel	Stainless steel	Stainless steel	Silver steel	Silver steel	Silver steel	Silver steel
Length mm (in.)	8.0 (0.32)	8.0 (0.32)	10.0 (0.40)	12.0 (0.48)	15.2 (0.60)	9.0 (0.36)	16.0 (0.63)
Mass grammes	1.8	1.4	1.5	2.7	4.6	1.5	2.1
For use on	LP2	LP2	LP2	MP10	TS27R	HPMA	HPMA
				MP12		HPRA	HPRA
				RMP60		HPPA	HPPA
				OMP60			
				MP3			
				MP11			



Use **P-TL09-0003** to tighten.

* Please note: If you require the full TS27R break stem kit, please order A-5003-5171.

Part number	A-5004-7616	A-5004-7618	A-5004-7619	A-5004-7620	A-5004-7622
	M3 Silver steel	M3 Silver steel	M3 Silver steel	M4 Silver steel	M4 Silver steel
Length mm (in.)	13.3 (0.52)	22.3 (0.88)	30.3 (1.19)	13.5 (0.53)	19.0 (0.75)
Mass grammes	2.43	3.6	4.5	1.37	2.2
For use on	TS20	TS20	TS20	RP1/2	TSA

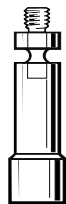

Cranked styli

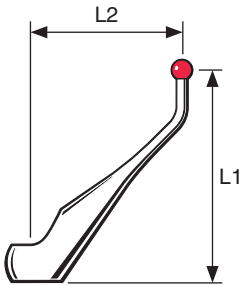
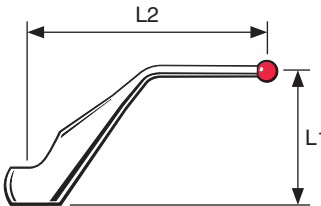
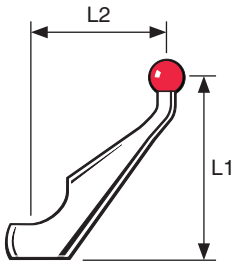
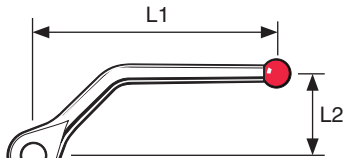
Part number	A-5000-5302 M4 Stainless steel	A-5000-5307 M4 Stainless steel	A-5000-6620 M4 Stainless steel	A-5000-7580 M4 Stainless steel
Ball diameter mm (in.)	3.0 (0.13)	3.0 (0.12)	5.0 (0.20)	4.0 (0.16)
Length L1 mm (in.)	32.0 (1.26)	20.1 (0.79)	27.4 (1.08)	38.8 (1.53)
Length L2 mm (in.)	21.9 (0.86)	34.9 (1.37)	19.0 (0.75)	12.5 (0.49)
Mass grammes	3.8	3.85	4.7	2.5
For use on	LP2	LP2	LP2	LP2
				

Tool datuming styli

Part number	A-5000-3212* Stainless steel	A-5000-6701* Stainless steel	A-5000-6713 Aluminium	A-5000-6403 Stainless steel
Overall length mm (in.)	53.0 (2.09)	43.0 (1.70)	96.5 (3.80)	32.5 (1.28)
Stem dia. mm (in.)	4.5 (0.18)	4.5 (0.18)	7.5 (0.30)	5.4 (0.22)
Mass grammes	4.5	4.3	21.9	11.0

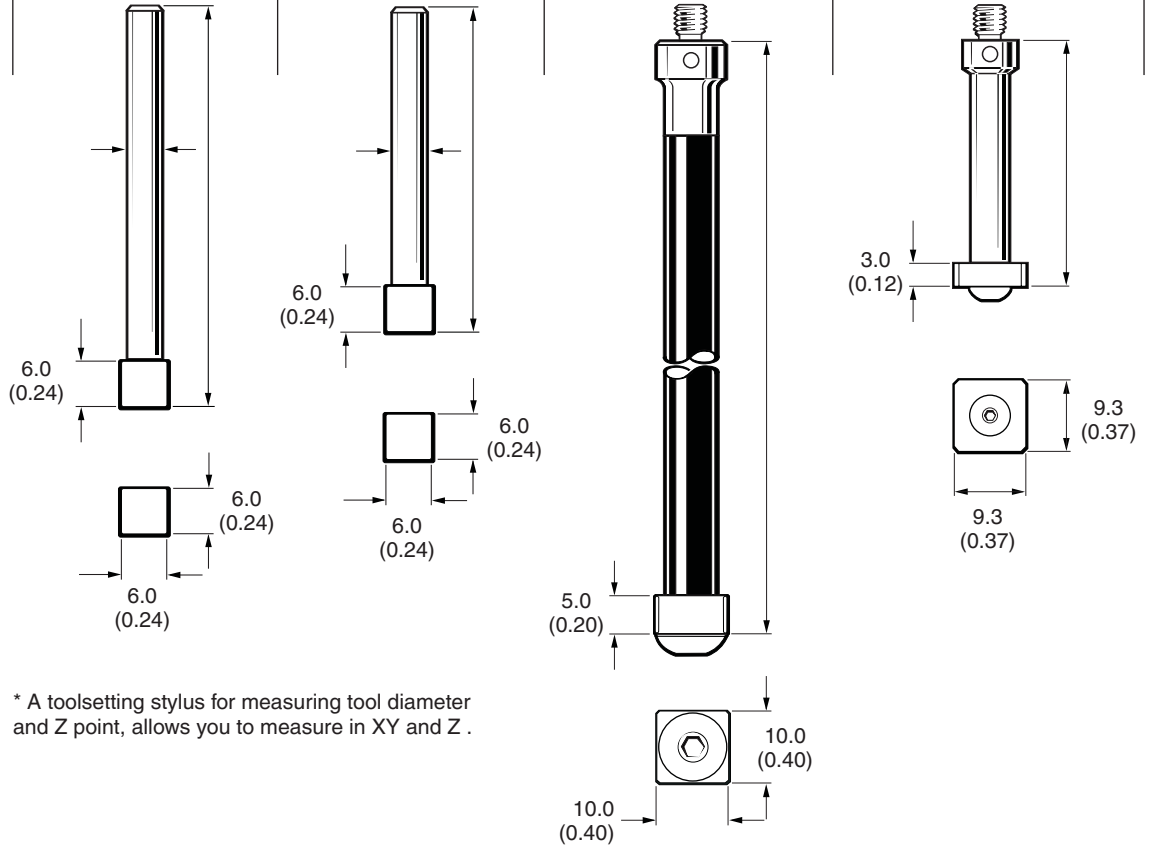

Part number	A-2116-0142
Length mm (in.)	30.3 (0.40)
Mass grammes	22.6
For use on	TSA

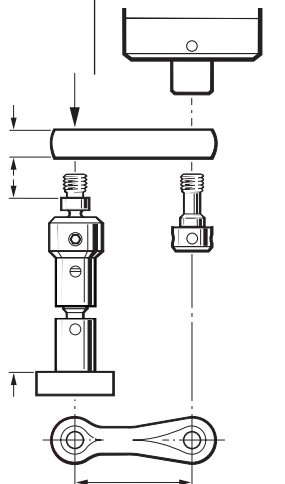

Tool datuming styli (continued)

Part number	A-2197-0157 Tungsten carbide	A-2197-0158 Tungsten carbide	A-2197-0159 Tungsten carbide	A-2197-0160 Tungsten carbide	A-2197-0161 Tungsten carbide	A-2197-0162 Tungsten carbide
Length mm (in.)	14.2 (0.56)	19.57 (0.77)	29.5 (1.16)	34.5 (1.36)	39.5 (1.55)	49.5 (1.95)
Mass grammes	14.86	16.0	20.0	20.7	21.8	23.5
For use on	HPPA	HPPA	HPPA	HPPA	HPPA	HPPA
	HPMA	HPMA	HPMA	HPMA	HPMA	HPMA
	HPRA	HPRA	HPRA	HPRA	HPRA	HPRA
	RP3	RP3	RP3	RP3	RP3	RP3
Replacement break stem	A-5004-7624	A-5004-7624	A-5004-6723	A-5004-6723	A-5004-6723	A-5004-6723

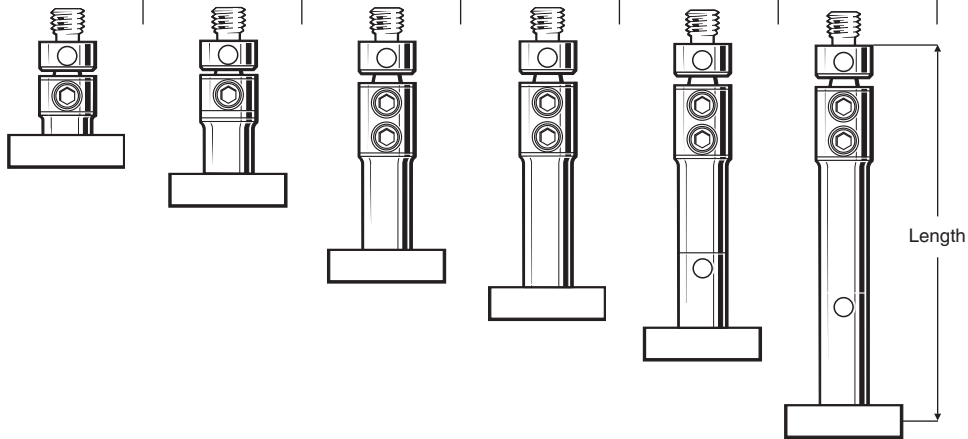

Part number	A-2008-0601 M3 Tungsten carbide	A-2008-0602 M3 Tungsten carbide	A-2008-0603 M3 Tungsten carbide	A-2048-2050 M4 Tungsten carbide	A-2048-2051 M4 Tungsten carbide	A-2116-0140 M4 Tungsten carbide	A-2116-0141 M4 Tungsten carbide
Length mm (in.)	15.4 (0.61)	24.0 (0.96)	32.4 (1.27)	23.2 (0.91)	32.0 (1.26)	32.0 (1.26)	42.0 (1.65)
Mass grammes	9.1	8.0	8.95	18.14	20.64	13.56	16.05
For use on	TS20	TS20	TS20	HPA (M6 MTG)	HPA (M6 MTG)	TSA	TSA
Replacement break stem	A-5004-7616	A-5004-7618	A-5004-7619	A-5004-7620	A-5004-7620	A-5004-7620	A-5004-7620

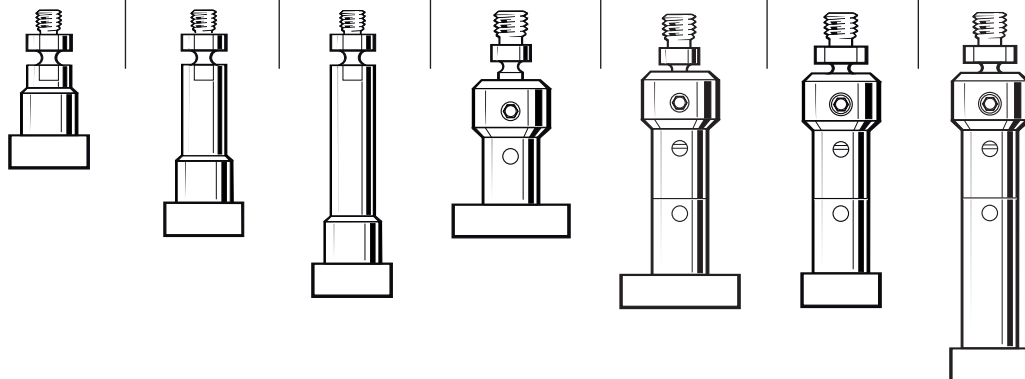

TS27R styli

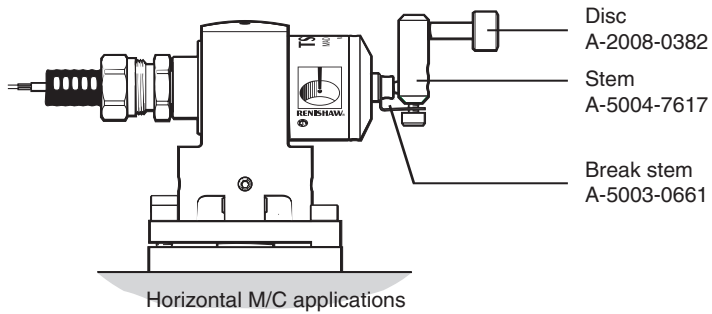
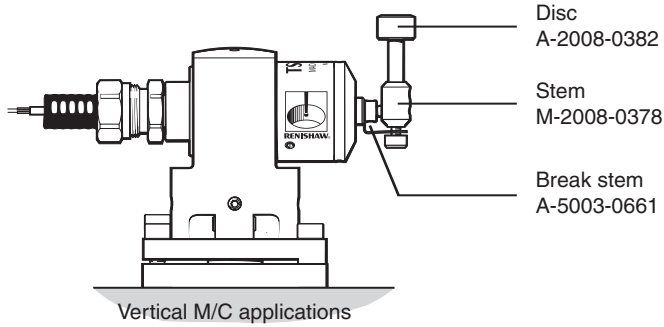

Horizontal machine application conversion
kit part number A-2008-0448

*Order also requires 2 x P-SC11-0404

TS27R styli – parallel shafted (not M4) – Not compatible with TS27 probes

Part number	A-2008-0382 Tungsten carbide	A-2008-0384 Ceramic
Overall length mm (in.)	23.0 (0.91)	22.0 (0.87)
Mass grammes	12.1	7.1

Stylus extensions

M4 threaded
stylus range

5.16

Part number	A-5004-7599 Stainless steel	A-5004-7600 Stainless steel	A-5004-7601 Stainless steel	A-5004-7602 Stainless steel	A-5000-7754 Ceramic	A-5000-7755 Ceramic	A-5000-7727 Ceramic	A-5003-0587 Ceramic
Length mm (in.)	10.0 (0.40)	15.0 (0.60)	20.0 (0.79)	30.0 (1.19)	30.0 (1.19)	50.0 (1.97)	100.0 (3.94)	200.0 (7.87)
Stem dia. mm (in.)	7.0 (0.28)	7.0 (0.28)	7.0 (0.28)	7.0 (0.28)	7.4 (0.30)	7.4 (0.30)	7.4 (0.30)	7.4 (0.30)
Mass grammes	2.4	3.7	4.8	7.4	5.1	6.7	10.6	26.7

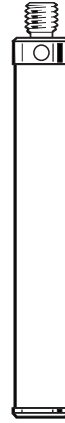

Tungsten carbide styli (stainless steel stems)

Part number	A-5000-7670	A-5000-7671	A-5000-7672	A-5000-9685	A-5000-9697
A Ball dia. mm (in.)	5.0 (0.20)	5.0 (0.20)	5.0 (0.20)	5.0 (0.20)	3.0 (0.12)
B Length mm (in.)	50.0 (1.97)	100.0 (3.94)	150.0 (5.91)	54.0 (2.12)	55.0 (2.17)
C Stem dia. mm (in.)	4.5 (0.18)	4.5 (0.18)	4.5 (0.18)	3.9 (0.15)	1.9 (0.07)
D EWL* mm (in.)	35.0 (1.38)	85.0 (3.35)	135.0 (5.31)	50.0 (1.97)	25.0 (0.99)
Mass grammes	6.2	11.9	18.2	6.9	3.8

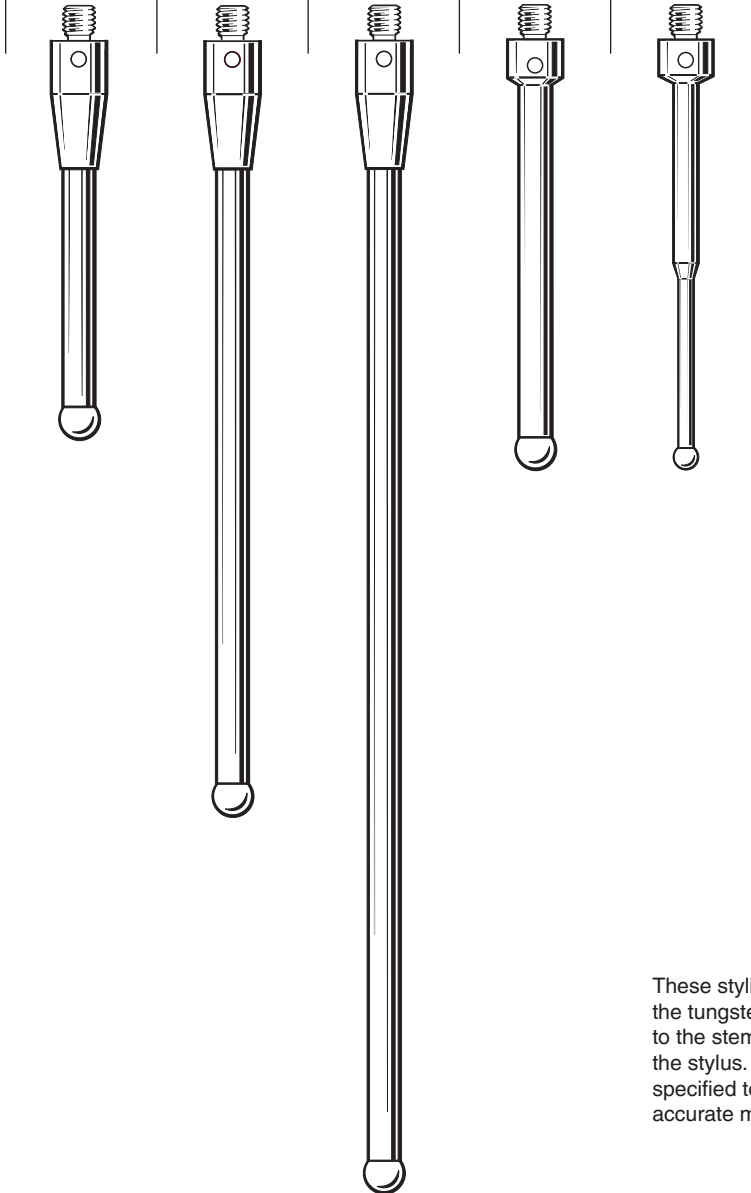

M4 threaded
 stylus range
5.17

These styli are for use on job contact probes; the tungsten carbide balls have been brazed to the stem to ensure conductivity through the stylus. The resistance of these styli are specified to be less than 0.1 Ω to ensure accurate measurement with your probe.

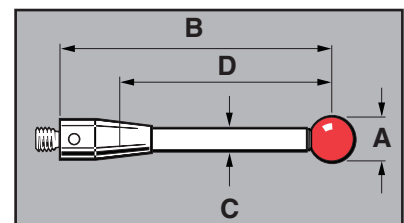

*Effective working length

M5 threaded stylus range

6.1

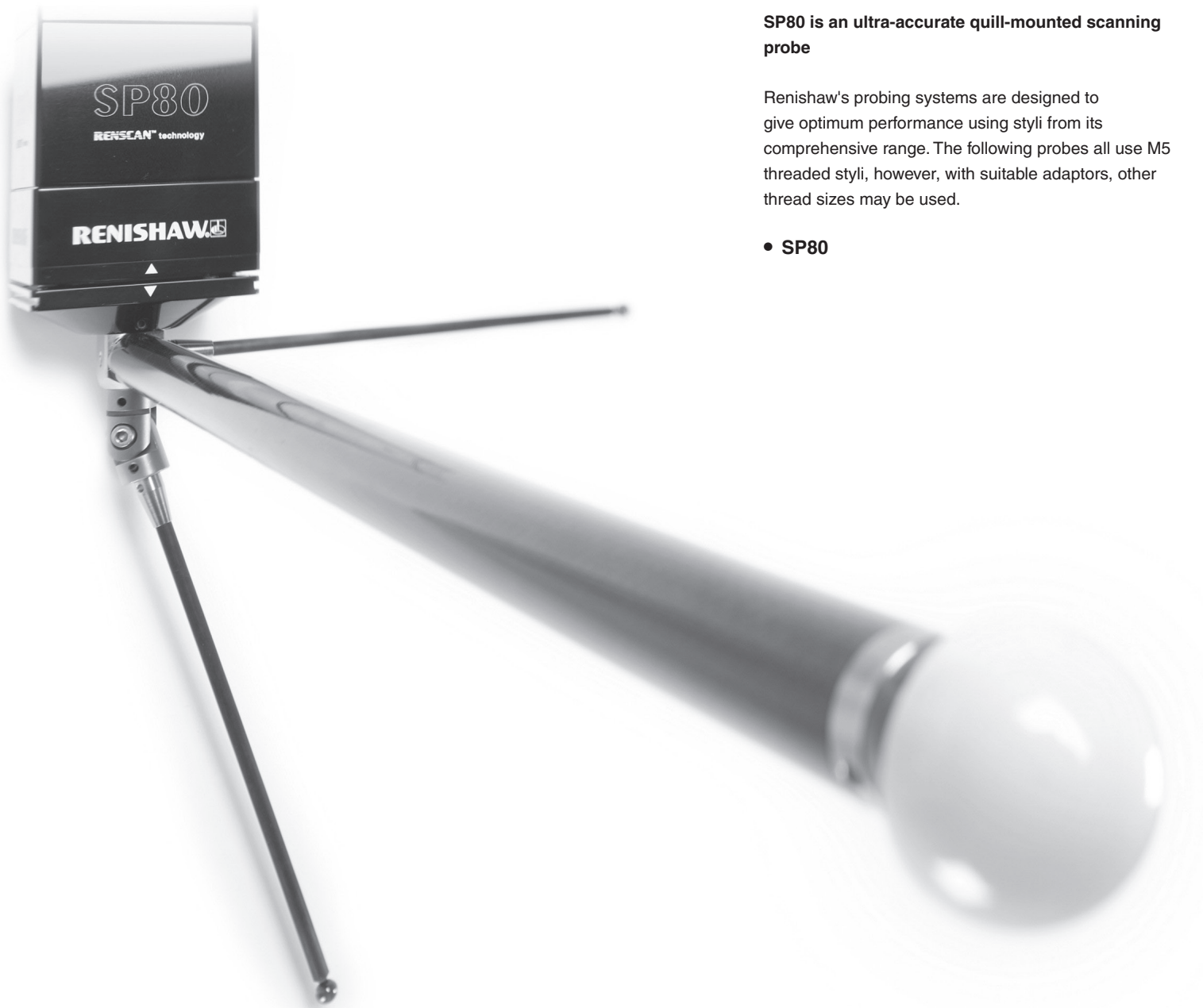

SP80 is an ultra-accurate quill-mounted scanning probe

Renishaw's probing systems are designed to give optimum performance using styli from its comprehensive range. The following probes all use M5 threaded styli, however, with suitable adaptors, other thread sizes may be used.

- SP80

Ruby micro ball styli (Tungsten carbide stems)

Part number	A-5003-5201	A-5003-5202	A-5003-5203
A Ball dia. mm (in.)	0.3 (0.012)	0.5 (0.020)	0.7 (0.028)
B Length mm (in.)	20.0 (0.79)	20.0 (0.79)	20.0 (0.79)
C Stem dia. mm (in.)	0.2 (0.008)	0.4 (0.016)	0.5 (0.020)
D EWL* mm (in.)	3.0 (0.12)	4.0 (0.16)	5.0 (0.20)
Mass grammes	6.5	6.5	6.5

20 mm range

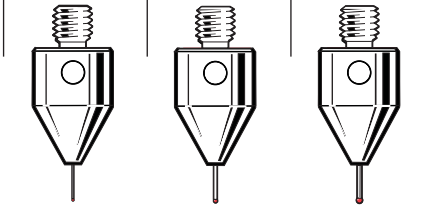

A-5003-5211	A-5003-5212	A-5003-5213
0.3 (0.012)	0.5 (0.020)	0.7 (0.028)
30.0 (1.19)	30.0 (1.19)	30.0 (1.19)
0.2 (0.008)	0.4 (0.016)	0.5 (0.020)
3.0 (0.12)	4.0 (0.16)	5.0 (0.20)
8.95	8.95	8.98

30 mm range

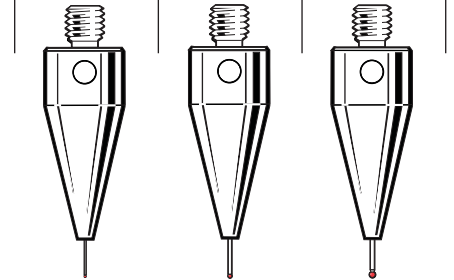

Part number	A-5003-5225	A-5003-5226	A-5003-5227
A Ball dia. mm (in.)	0.3 (0.012)	0.5 (0.020)	0.7 (0.028)
B Length mm (in.)	50.0 (1.97)	50.0 (1.97)	50.0 (1.97)
C Stem dia. mm (in.)	0.2 (0.008)	0.4 (0.016)	0.5 (0.020)
D EWL* mm (in.)	3.0 (0.12)	4.0 (0.16)	5.0 (0.20)
Mass grammes	15.79	15.79	15.79

50 mm range

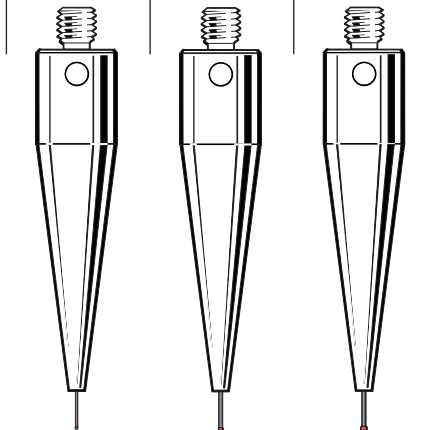

A-5003-5240	A-5003-5241	A-5003-5242
0.3 (0.012)	0.5 (0.020)	0.7 (0.028)
75.0 (2.96)	75.0 (2.96)	75.0 (2.96)
0.2 (0.008)	0.4 (0.016)	0.5 (0.020)
3.0 (0.12)	4.0 (0.16)	5.0 (0.20)
23.84	23.84	23.84

75 mm range

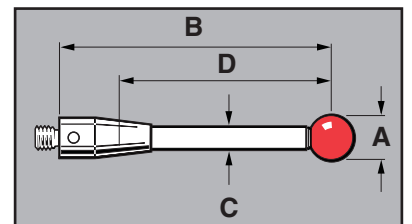
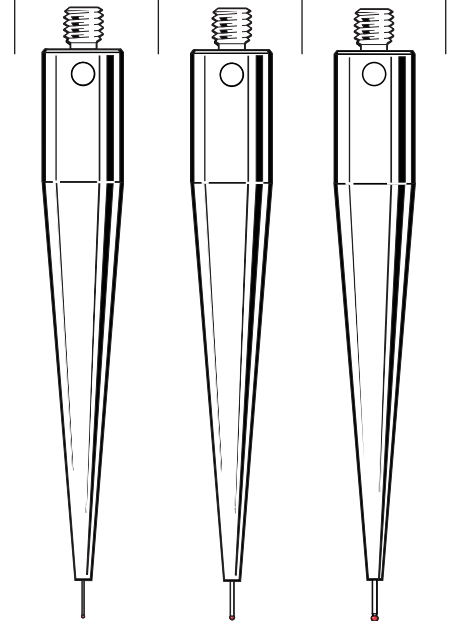

Ruby ball styli (tungsten carbide stems)

Ball material		Part number						
Ruby		A-5003-5204	A-5003-5205	A-5003-5206	A-5003-5207	A-5003-5208	A-5003-5209	A-5003-5210
Silicon nitride				A-5003-5732			A-5003-5733	
Zirconia				A-5003-5746			A-5003-5747	
A	Ball dia. mm (in.)	1.0 (0.04)	1.5 (0.06)	2.0 (0.08)	2.5 (0.10)	3.0 (0.12)	4.0 (0.16)	5.0 (0.20)
B	Length mm (in.)	20.0 (0.79)	20.0 (0.79)	20.0 (0.79)	20.0 (0.79)	20.0 (0.79)	20.0 (0.79)	20.0 (0.79)
C	Stem dia. mm (in.)	0.7 (0.028)	1.0 (0.04)	1.0 (0.04)	1.5 (0.06)	2.0 (0.08)	2.0 (0.08)	3.0 (0.12)
D	EWL* mm (in.)	5.0 (0.20)	11.0 (0.44)	11.0 (0.44)	11.0 (0.44)	11.0 (0.44)	11.9 (0.47)	11.5 (0.45)
	Mass grammes	6.52	4.68	4.70	4.84	5.12	5.19	6.06

20 mm range

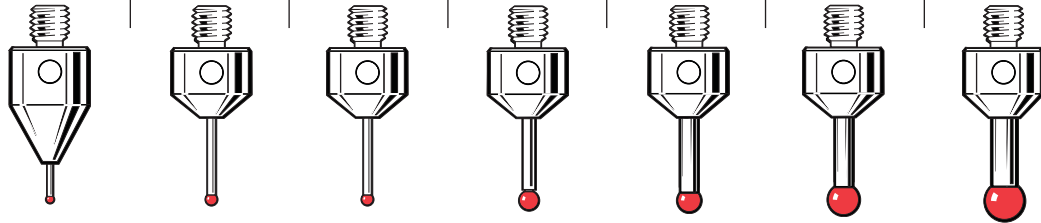

Part number	A-5003-5214	A-5003-5215	A-5003-5216	A-5003-5217	A-5003-5218	A-5003-5219	A-5003-5220	
A	Ball dia. mm (in.)	1.0 (0.04)	1.5 (0.06)	2.0 (0.08)	2.5 (0.10)	3.0 (0.12)	4.0 (0.16)	5.0 (0.20)
B	Length mm (in.)	30.0 (1.19)	30.0 (1.19)	30.0 (1.19)	30.0 (1.19)	30.0 (1.19)	30.0 (1.19)	30.0 (1.19)
C	Stem dia. mm (in.)	0.7 (0.028)	1.0 (0.04)	1.0 (0.04)	1.5 (0.06)	2.0 (0.08)	2.0 (0.08)	3.0 (0.12)
D	EWL* mm (in.)	5.0 (0.20)	12.0 (0.48)	21.0 (0.83)	21.0 (0.83)	21.0 (0.83)	21.9 (0.86)	21.5 (0.85)
	Mass grammes	9.01	7.28	4.81	5.14	5.58	5.64	7.10

30 mm range

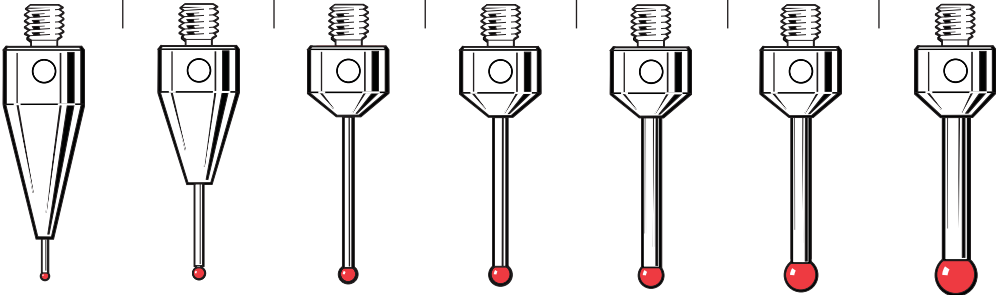

Part number	A-5003-5221	A-5003-5222	A-5003-5223	A-5003-5224	
A	Ball dia. mm (in.)	1.5 (0.06)	2.0 (0.08)	2.5 (0.10)	3.0 (0.12)
B	Length mm (in.)	40.0 (1.58)	40.0 (1.58)	40.0 (1.58)	40.0 (1.58)
C	Stem dia. mm (in.)	1.0 (0.04)	1.0 (0.04)	1.5 (0.06)	2.0 (0.08)
D	EWL* mm (in.)	22.0 (0.87)	31.0 (1.23)	31.0 (1.23)	31.0 (1.23)
	Mass grammes	7.39	4.93	5.40	6.04

40 mm range

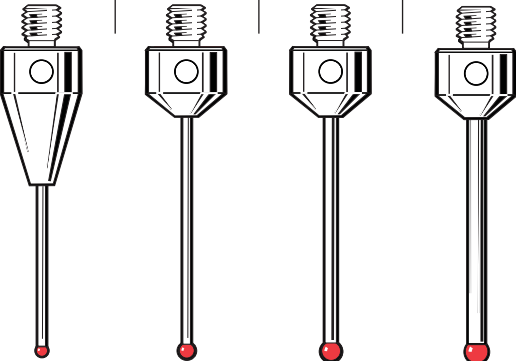

*Effective working length

Ruby ball styli (tungsten carbide stems – <5 mm ball diameter)

Part number	A-5003-5228	A-5003-5229	A-5003-5230	A-5003-5231	A-5003-5233	A-5003-5232	A-5003-5234	A-5003-5235
A Ball dia. mm (in.)	1.0 (0.04)	1.5 (0.06)	2.0 (0.08)	2.0 (0.08)	2.5 (0.10)	2.5 (0.10)	3.0 (0.12)	4.0 (0.16)
B Length mm (in.)	50.0 (1.97)	50.0 (1.97)	50.0 (1.97)	50.0 (1.97)	50.0 (1.97)	50.0 (1.97)	50.0 (1.97)	50.0 (1.97)
C Stem dia. mm (in.)	0.7 (0.028)	1.0 (0.04)	1.0 (0.04)	1.0 (0.04)	1.5 (0.06)	2.0 (0.08)	2.0 (0.08)	2.0 (0.08)
D EWL* mm (in.)	5.0 (0.20)	5.0 (0.20)	41.0 (1.62)	5.0 (0.20)	5.0 (0.20)	41.0 (1.62)	41.0 (1.62)	41.9 (1.65)
Mass grammes	15.81	14.82	5.05	14.85	14.94	6.48	6.50	6.55

50 mm range

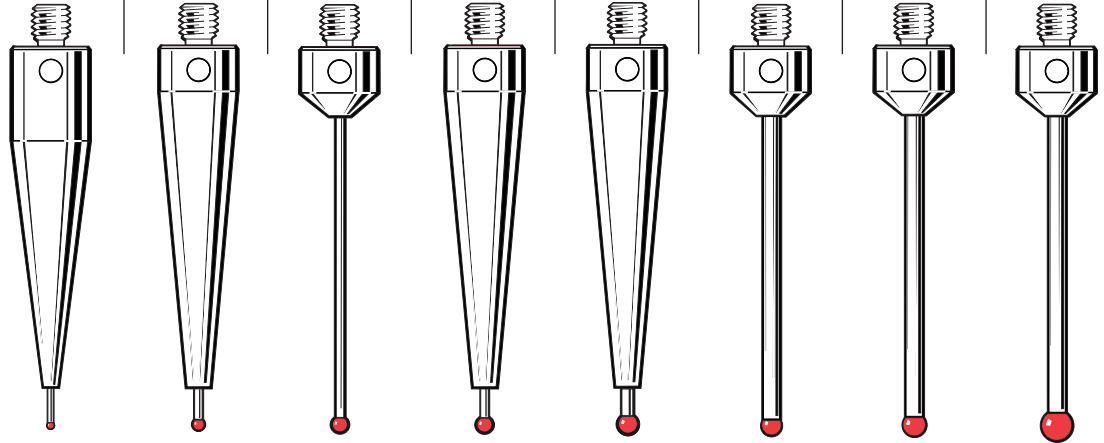

Ruby ball styli (≥5 mm ball diameter)

Ball material	Part number			
Ruby	A-5003-5236	A-5003-5237	A-5003-5238	A-5003-5239
Silicon nitride		A-5003-5734		
Zirconia			A-5003-5748	
	Tungsten carbide	Carbon fibre	Carbon fibre	Carbon fibre
A Ball dia. mm (in.)	5.0 (0.20)	6.0 (0.24)	8.0 (0.32)	10.0 (0.40)
B Length mm (in.)	50.0 (1.97)	50.0 (1.97)	50.0 (1.97)	50.0 (1.97)
C Stem dia. mm (in.)	3.0 (0.12)	4.0 (0.16)	6.0 (0.24)	6.0 (0.24)
D EWL* mm (in.)	41.5 (1.63)	39.5 (1.55)	39.5 (1.55)	44.5 (1.75)
Mass grammes	9.19	6.10	7.96	8.91

50 mm range

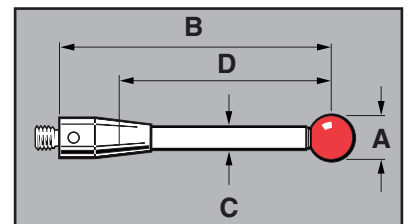
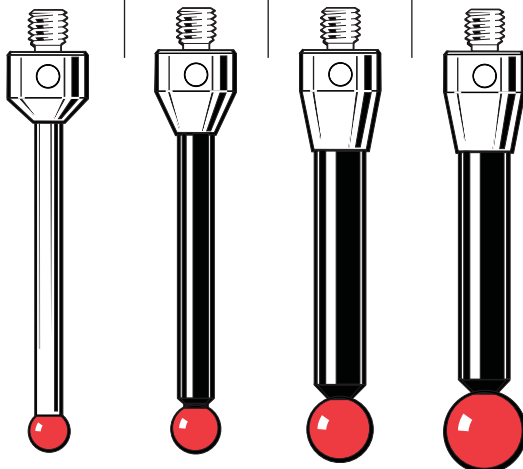

Ruby ball styli (1 mm – 10 mm ball diameter)

Part number		A-5003-5243	A-5003-5244	A-5003-5248	A-5003-5249	A-5003-5250	A-5003-5251	A-5003-5252
		Tungsten carbide	Tungsten carbide	Tungsten carbide	Tungsten carbide	Carbon fibre	Carbon fibre	Carbon fibre
A	Ball dia. mm (in.)	1.0 (0.04)	1.5 (0.06)	4.0 (0.16)	5.0 (0.20)	6.0 (0.24)	8.0 (0.32)	10.0 (0.40)
B	Length mm (in.)	75.0 (2.96)	75.0 (2.96)	75.0 (2.96)	75.0 (2.96)	75.0 (2.96)	75.0 (2.96)	75.0 (2.96)
C	Stem dia. mm (in.)	0.7 (0.028)	1.0 (0.04)	3.0 (0.12)	3.0 (0.12)	4.0 (0.16)	6.0 (0.24)	6.0 (0.24)
D	EWL* mm (in.)	5.0 (0.20)	5.0 (0.20)	66.0 (2.60)	66.0 (2.60)	65.1 (2.56)	64.5 (2.54)	69.5 (2.74)
	Mass grammes	23.86	23.90	11.61	11.80	6.59	9.06	10.01

75 mm range

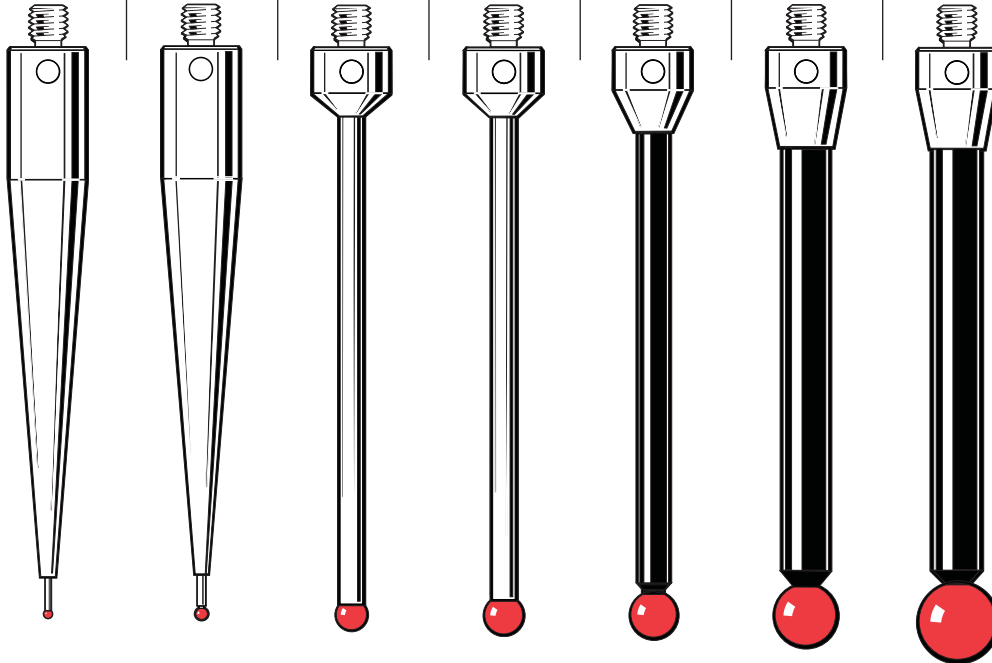

M5 threaded
 stylus range

6.5

*Effective working length

Ruby ball styli (≤ 50 mm EWL)

Ball material		Part number				
Ruby		A-5003-5253	A-5003-5255	A-5003-5256	A-5003-5257	A-5003-5261
Silicon nitride						
Zirconia						
		Tungsten carbide	Tungsten carbide	Tungsten carbide	Tungsten carbide	Carbon fibre
A	Ball dia. mm (in.)	3.0 (0.12)	4.0 (0.16)	4.0 (0.16)	5.0 (0.20)	8.0 (0.32)
B	Length mm (in.)	100.0 (3.94)	100.0 (3.94)	100.0 (3.94)	100.0 (3.94)	100.0 (3.94)
C	Stem dia. mm (in.)	2.0 (0.08)	2.0 (0.08)	3.0 (0.12)	3.0 (0.12)	6.0 (0.24)
D	EWL* mm (in.)	20.0 (0.79)	30.5 (1.20)	50.0 (1.97)	50.0 (1.97)	50.0 (1.97)
	Mass grammes	25.71	25.75	23.07	23.31	22.97

100 mm range

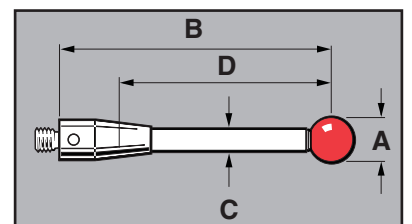
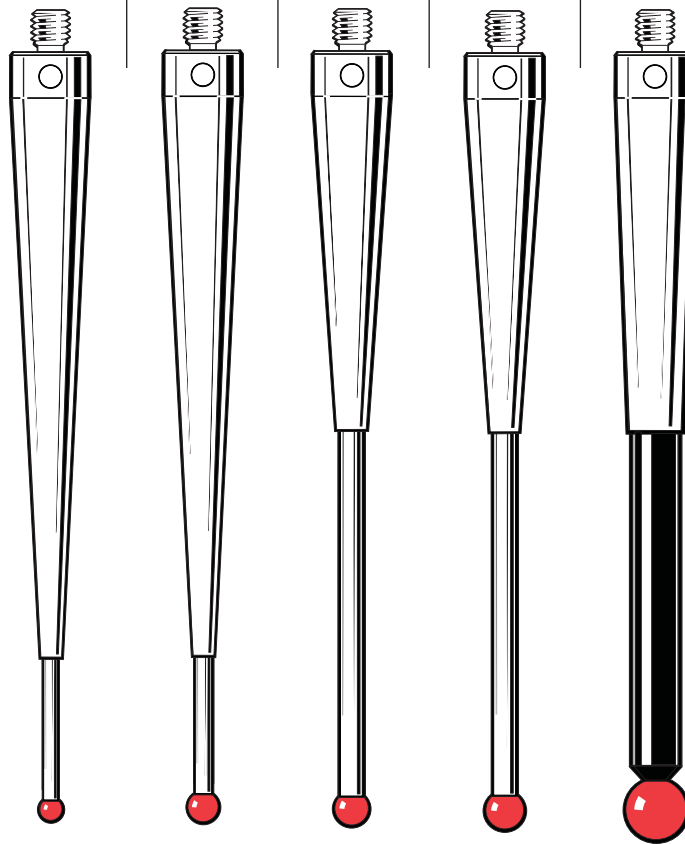

Ruby ball styli (>50 mm EWL)

Ball material		Part number						
Ruby		A-5003-5254	A-5003-5258	A-5003-5259	A-5003-5260	A-5003-5262	A-5003-5264	A-5003-5263
Silicon nitride				A-5003-5735				
Zirconia				A-5003-5749				
		Tungsten carbide	Tungsten carbide	Carbon fibre	Carbon fibre	Carbon fibre	Carbon fibre	Carbon fibre
A	Ball dia. mm (in.)	3.0 (0.12)	5.0 (0.20)	6.0 (0.24)	6.0 (0.24)	8.0 (0.32)	10.0 (0.40)	10.0 (0.40)
B	Length mm (in.)	100.0 (3.94)	100.0 (3.94)	100.0 (3.94)	100.0 (3.94)	100.0 (3.94)	100.0 (3.94)	100.0 (3.94)
C	Stem dia. mm (in.)	1.5 (0.06)	3.0 (0.12)	4.0 (0.16)	4.0 (0.16)	6.0 (0.24)	6.0 (0.24)	6.0 (0.24)
D	EWL* mm (in.)	55.0 (2.17)	91.0 (3.59)	58.9 (2.32)	90.1 (3.55)	89.5 (3.52)	94.5 (3.72)	95.5 (3.76)
	Mass grammes	16.30	14.40	19.66	7.08	10.17	11.11	23.91

100 mm range

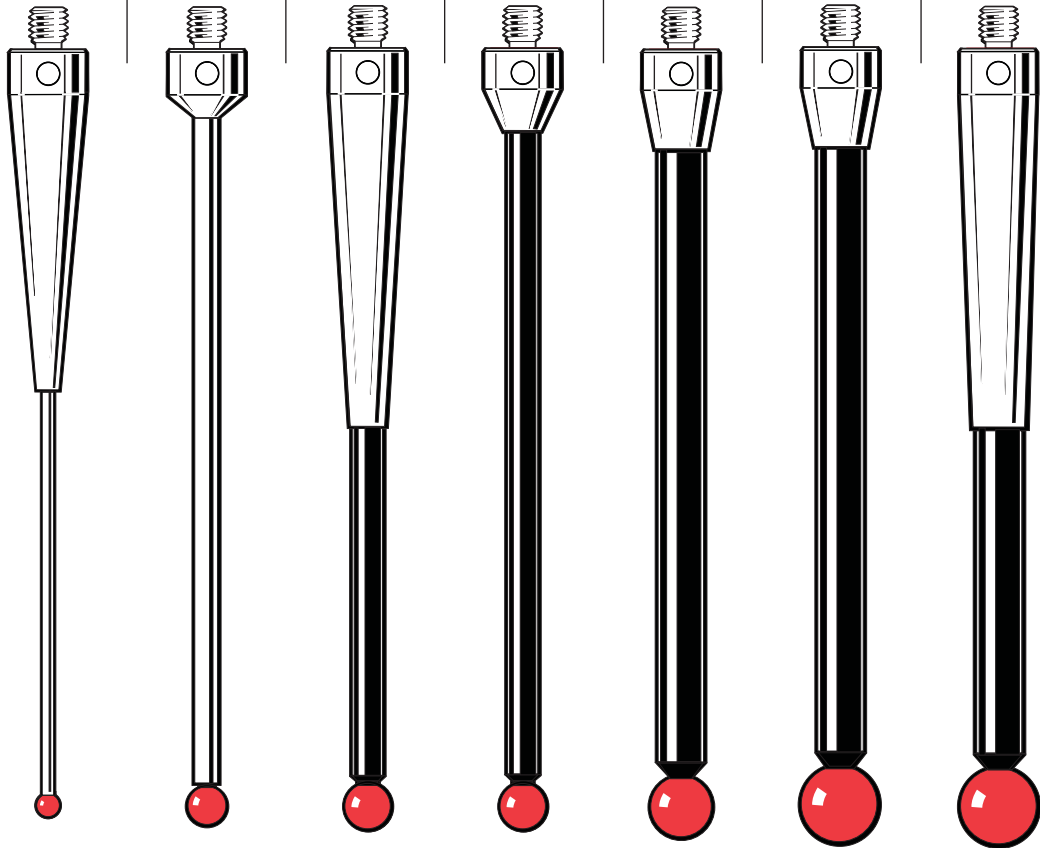

*Effective working length

Ruby ball styli (carbon fibre stems)

Part number	A-5003-5265	A-5003-5266	A-5003-5267
A Ball dia. mm (in.)	6.0 (0.24)	8.0 (0.32)	10.0 (0.40)
B Length mm (in.)	150.0 (5.91)	150.0 (5.91)	150.0 (5.91)
C Stem dia. mm (in.)	4.0 (0.16)	6.0 (0.24)	6.0 (0.24)
D EWL* mm (in.)	137.0 (5.39)	135.0 (5.31)	144.5 (5.69)
Mass grammes	9.09	13.71	14.66

150 mm range

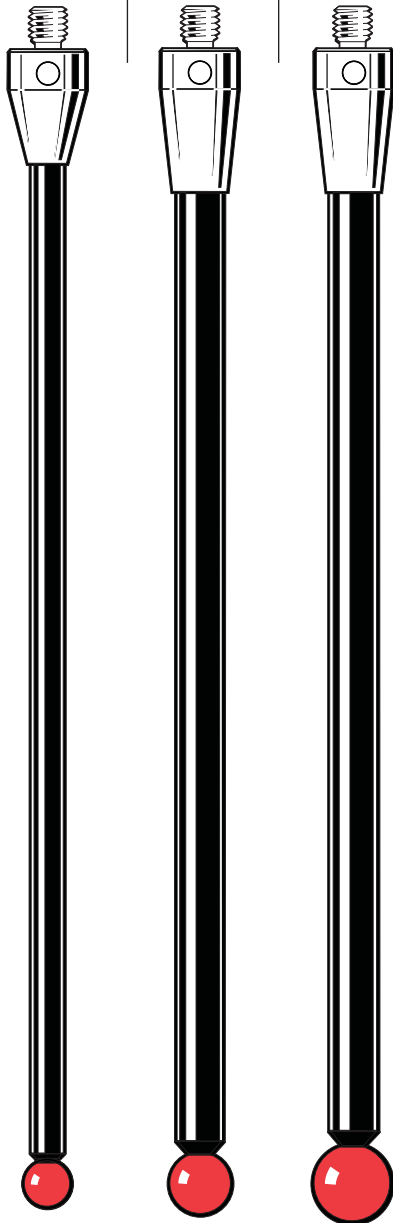

A-5003-5268	A-5003-5269	A-5003-5270
6.0 (0.24)	8.0 (0.32)	10.0 (0.40)
200.0 (7.88)	200.0 (7.88)	200.0 (7.88)
4.0 (0.16)	6.0 (0.24)	6.0 (0.24)
187.0 (7.36)	180.0 (7.09)	194.5 (7.66)
10.07	15.92	16.87

200 mm range

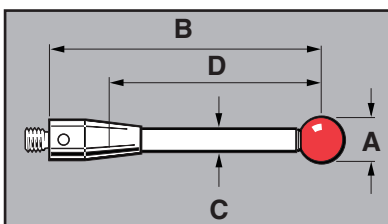
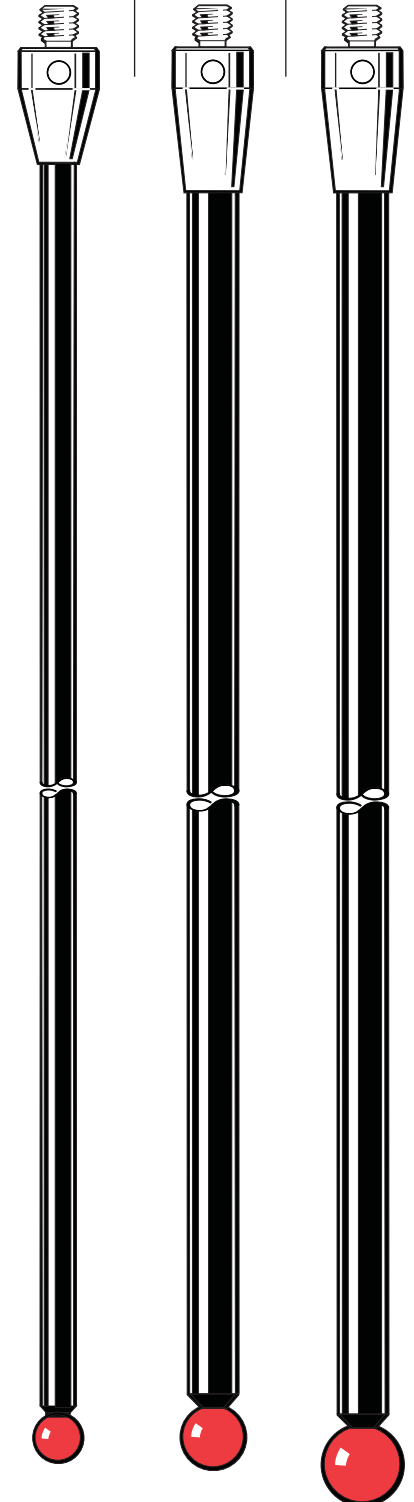

Ruby ball styli (carbon fibre stems)

Part number	A-5003-5271	A-5003-5272	A-5003-5273
A Ball dia. mm (in.)	6.0 (0.24)	8.0 (0.32)	10.0 (0.40)
B Length mm (in.)	300.0 (11.82)	300.0 (11.82)	300.0 (11.82)
C Stem dia. mm (in.)	4.0 (0.16)	6.0 (0.24)	6.0 (0.24)
D EWL* mm (in.)	287.0 (11.30)	280.0 (11.03)	294.5 (11.59)
Mass grammes	12.02	20.33	21.28

300 mm range

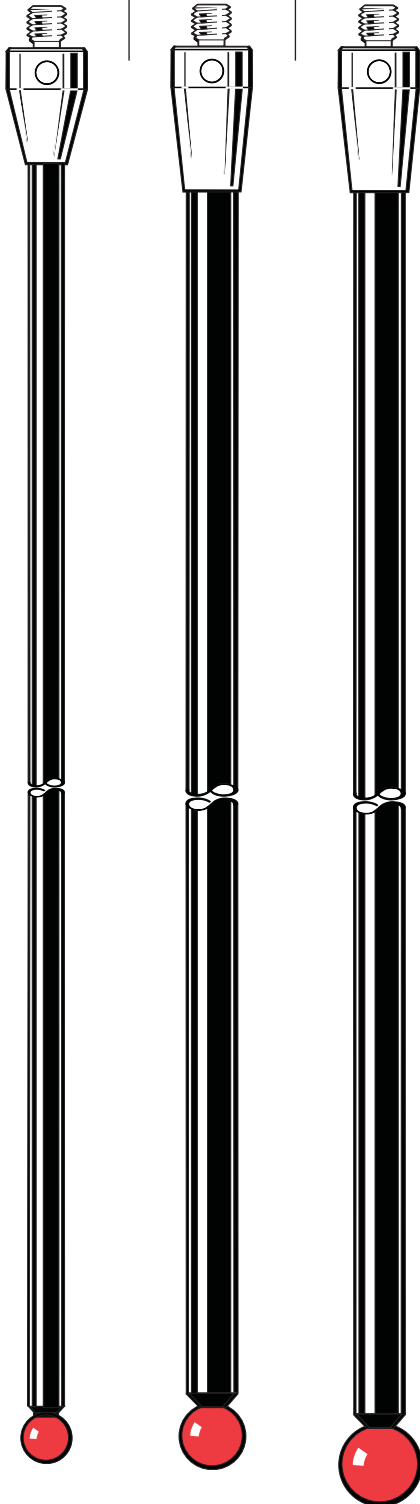

M5 threaded
 styli range

6.9

* Effective working length

Stylus extensions – thermo stable carbon fibre stems, titanium ends (stem dia. 11 mm)

Part number	A-5555-0647	A-5555-0648	A-5555-0649	A-5555-0623	A-5555-0650	A-5555-0651	A-5555-0652
Length mm (in.)	40.0 (1.58)	50.0 (1.97)	60.0 (2.37)	70.0 (2.76)	80.0 (3.15)	90.0 (3.55)	100.0 (3.94)
Stem dia. mm (in.)	11.0 (0.44)	11.0 (0.44)	11.0 (0.44)	11.0 (0.44)	11.0 (0.44)	11.0 (0.44)	11.0 (0.44)
Mass grammes	7.6	8.3	9.0	9.7	10.4	11.1	11.8

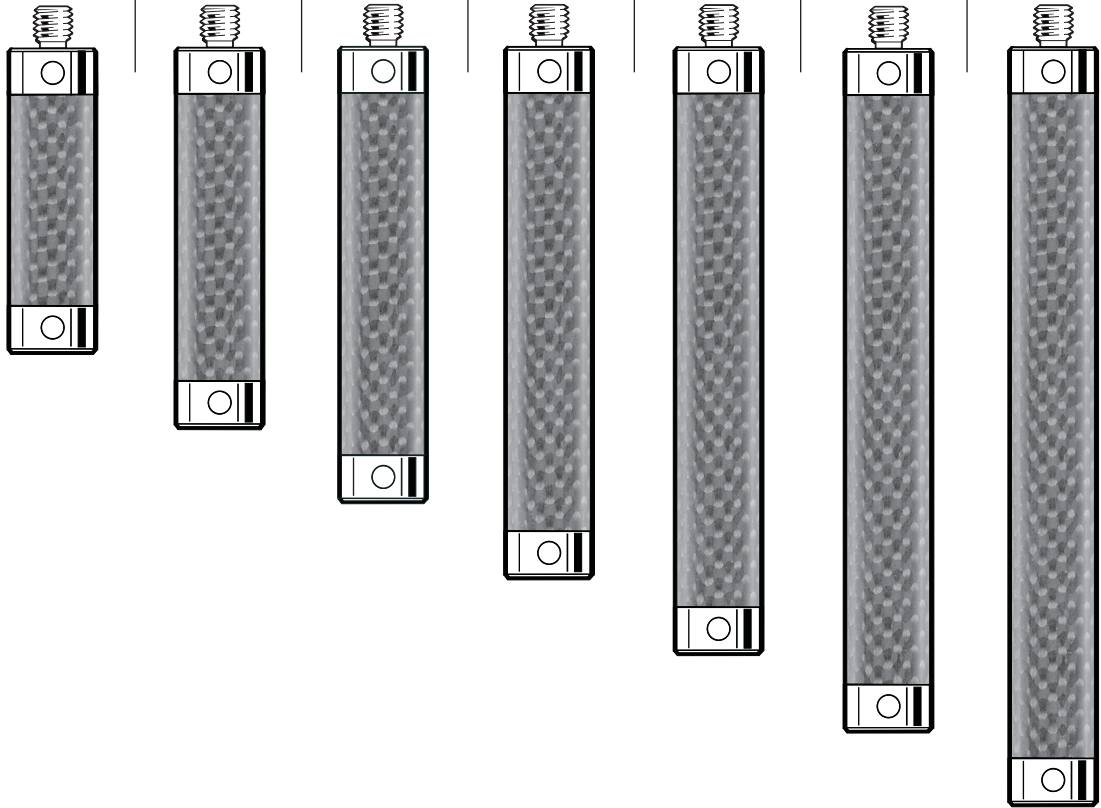

M5 extension tools

A-5003-6134

For M5 threaded extensions with
11 mm (0.44 in.) stem diameter

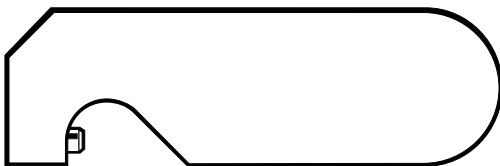

A-5003-6135

For M5 threaded extensions with
20 mm (0.79 in.) stem diameter

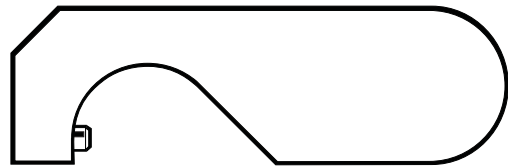

These tools are designed to fit styli extensions to Renishaw probes without causing internal damage

Stylus extensions – thermo stable carbon fibre stems, titanium ends (stem dia. 11 mm)

Part number	A-5555-0425	A-5555-0424	A-5555-0653	A-5555-0654	A-5555-0655	A-5555-0642	A-5555-0656
Length mm (in.)	120.0 (4.73)	150.0 (5.91)	180.0 (7.09)	200.0 (7.88)	250.0 (9.85)	300.0 (11.82)	400.0 (15.76)
Stem dia. mm (in.)	11.0 (0.44)	11.0 (0.44)	11.0 (0.44)	11.0 (0.44)	11.0 (0.44)	11.0 (0.44)	11.0 (0.44)
Mass grammes	13.2	15.4	17.5	18.9	22.4	25.9	33.0

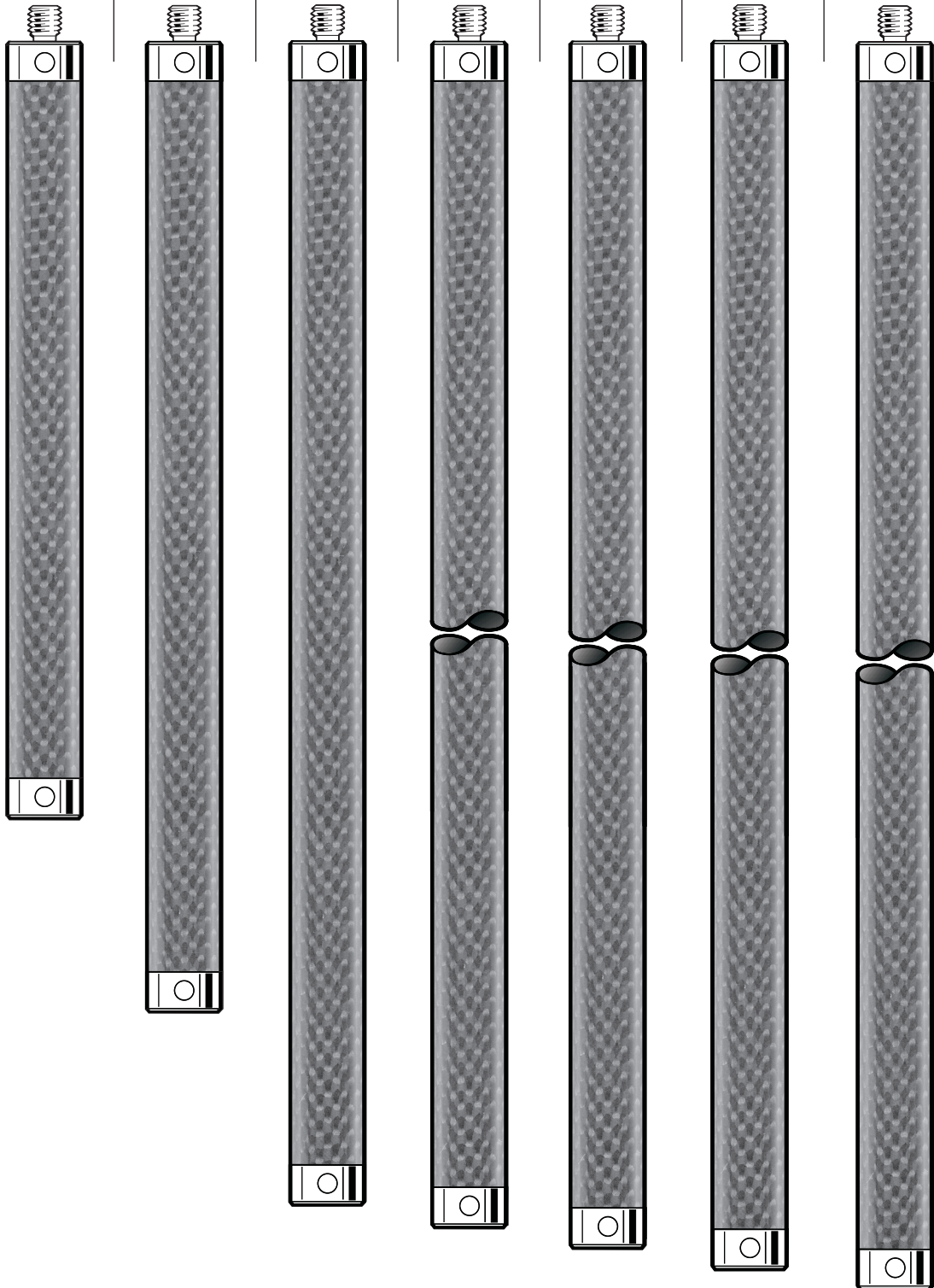

Stylus extensions – thermo stable carbon fibre stems, titanium ends (stem dia. 20 mm)

Part number	A-5555-0620	A-5555-0657	A-5555-0658	A-5555-0621	A-5555-0659	A-5555-0660	A-5555-0661
Length mm (in.)	40.0 (1.58)	50.0 (1.97)	60.0 (2.37)	80.0 (3.15)	100.0 (3.94)	120.0 (4.73)	150.0 (5.91)
Stem dia. mm (in.)	20.0 (0.79)	20.0 (0.79)	20.0 (0.79)	20.0 (0.79)	20.0 (0.79)	20.0 (0.79)	20.0 (0.79)
Mass grammes	23.8	25.1	26.5	29.3	32.1	34.9	39.0

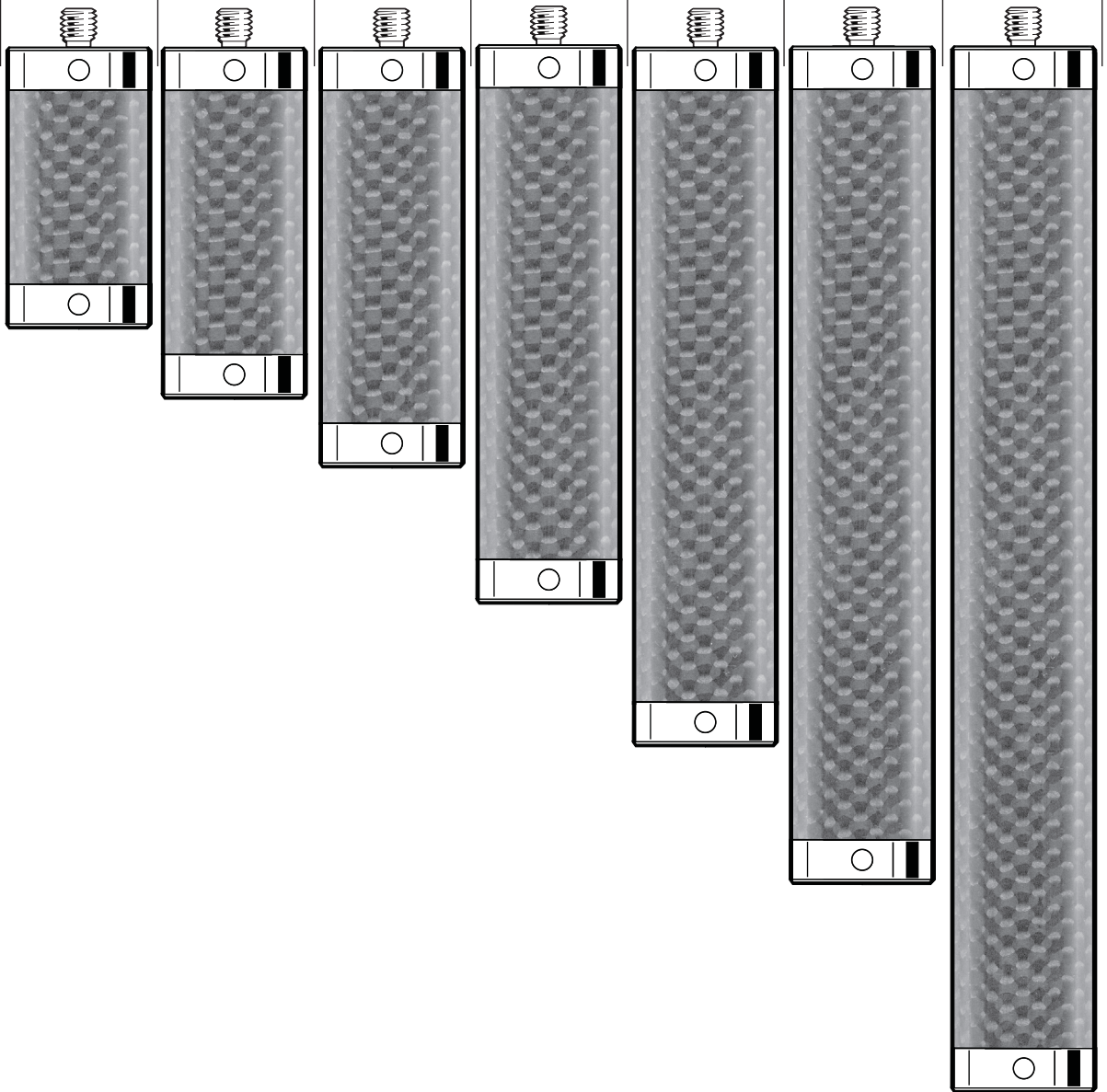

Stylus extensions – thermo stable carbon fibre stems, titanium ends (stem dia. 20 mm)

Part number	A-5555-0662	A-5555-0663	A-5555-0427	A-5555-0664	A-5555-0665	A-5555-0667	A-5555-0668
Length mm (in.)	180.0 (7.09)	200.0 (7.88)	250.0 (9.85)	300.0 (11.82)	400.0 (15.76)	500.0 (19.70)	600.0 (23.64)
Stem dia. mm (in.)	20.0 (0.79)	20.0 (0.79)	20.0 (0.79)	20.0 (0.79)	20.0 (0.79)	20.0 (0.79)	20.0 (0.79)
Mass grammes	43.2	46.0	52.9	59.9	73.8	87.7	101.5

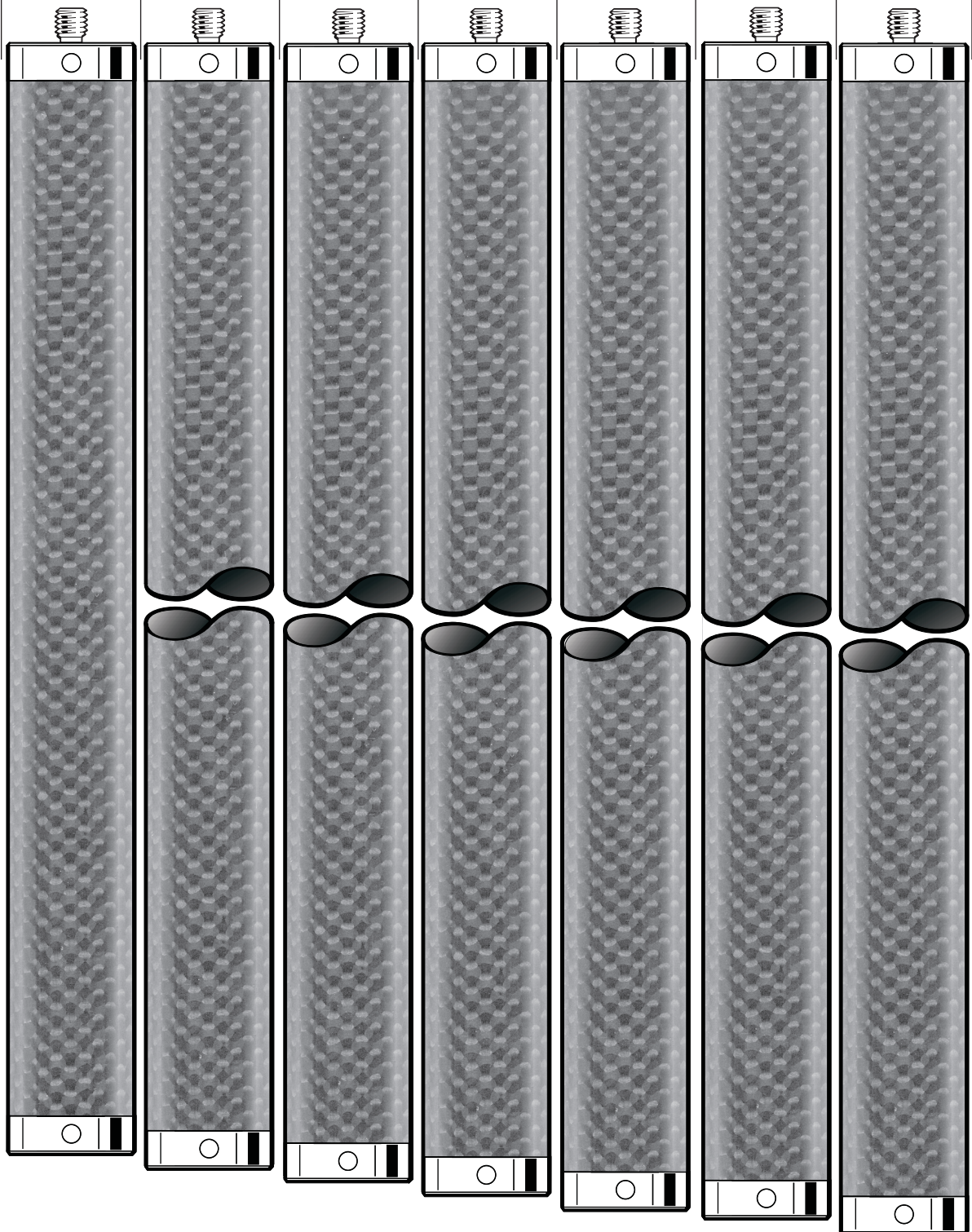

Stylus extensions – stainless steel

Part number	A-5555-0142	A-5555-0140	A-5555-0669	A-5555-0670	A-5555-0136
Length mm (in.)	10.0 (0.40)	20.0 (0.79)	30.0 (1.19)	50.0 (1.97)	100.0 (3.94)
Stem dia. mm (in.)	11.0 (0.44)	11.0 (0.44)	11.0 (0.44)	11.0 (0.44)	11.0 (0.44)
Mass grammes	6.0	13.0	20.0	34.8	73.0

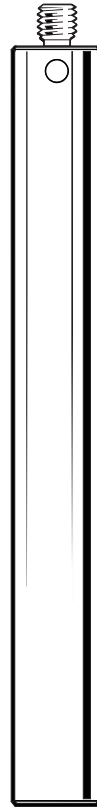
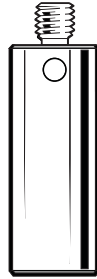
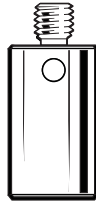
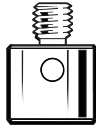

Stylus extensions – aluminium

Part number	A-5555-0671	A-5555-0127	A-5555-0125
Length mm (in.)	50.0 (1.97)	100.0 (3.94)	200.0 (7.88)
Stem dia. mm (in.)	20.0 (0.79)	20.0 (0.79)	20.0 (0.79)
Mass grammes	47.2	50.0	85.0



Disc styli – silver steel

Part number	A-5003-5288	A-5003-5289	A-5003-5290	A-5003-5291
Disc dia. mm (in.)	12.0 (0.48)	21.0 (0.83)	35.0 (1.38)	63.5 (2.51)
Disc depth mm (in.)	3.0 (0.12)	3.0 (0.12)	5.0 (0.20)	5.0 (0.20)
Roller depth mm (in.)	5.0 (0.20)	5.0 (0.20)	8.0 (0.31)	8.0 (0.31)
Mass grammes	2.52	5.23	14.0	51.0

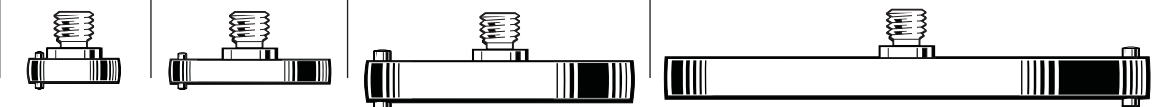

Hemispherical styli – ceramic

Part number	A-5003-5275	A-5003-5276	A-5003-5277
Ball dia. mm (in.)	16.0 (0.63)	22.0 (0.87)	30.0 (1.18)
Length mm (in.)	19.5 (0.77)	20.5 (0.81)	24.5 (0.96)
Mass grammes	7.0	14.0	19.7

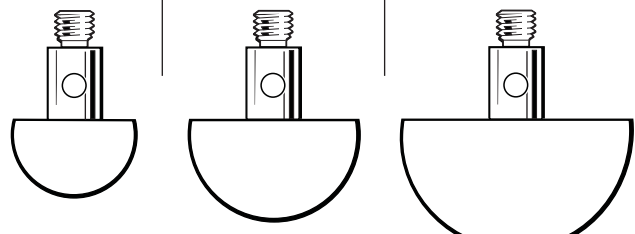
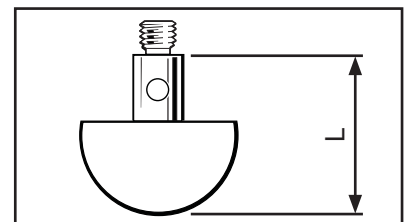
Styli for Faro arms

7.1



Styli for Faro arms

These styli have been designed especially for use on Faro portable arm CMMs. Their robust design and construction utilizes Grade 5 Zirconia balls that have a high fracture toughness. The balls are bonded to the high strength tungsten carbide stem with impact resistant adhesive, and specialist construction techniques have been incorporated to ensure that the joint between the body and stem is extremely rigid and virtually indestructible.

1¼–20 UN thread styli

Part number	A-5003-7673 Zirconia	A-5003-7674 Zirconia	A-5003-7675 Tungsten carbide
Ball dia. (mm)	3	6	N/A
Length (mm)	57	57	57

M6 styli

Part number	A-5003-7676 Zirconia	A-5003-7677 Zirconia	A-5003-7678 Zirconia	A-5003-7679 Zirconia
Ball diameter	1/8 in.	¼ in.	3 mm	6 mm
Length (mm)	43	43	43	43

Faro kit

Styli for Faro arms
7.3

A-5003-9190 Faro probe kit 0073 12 piece

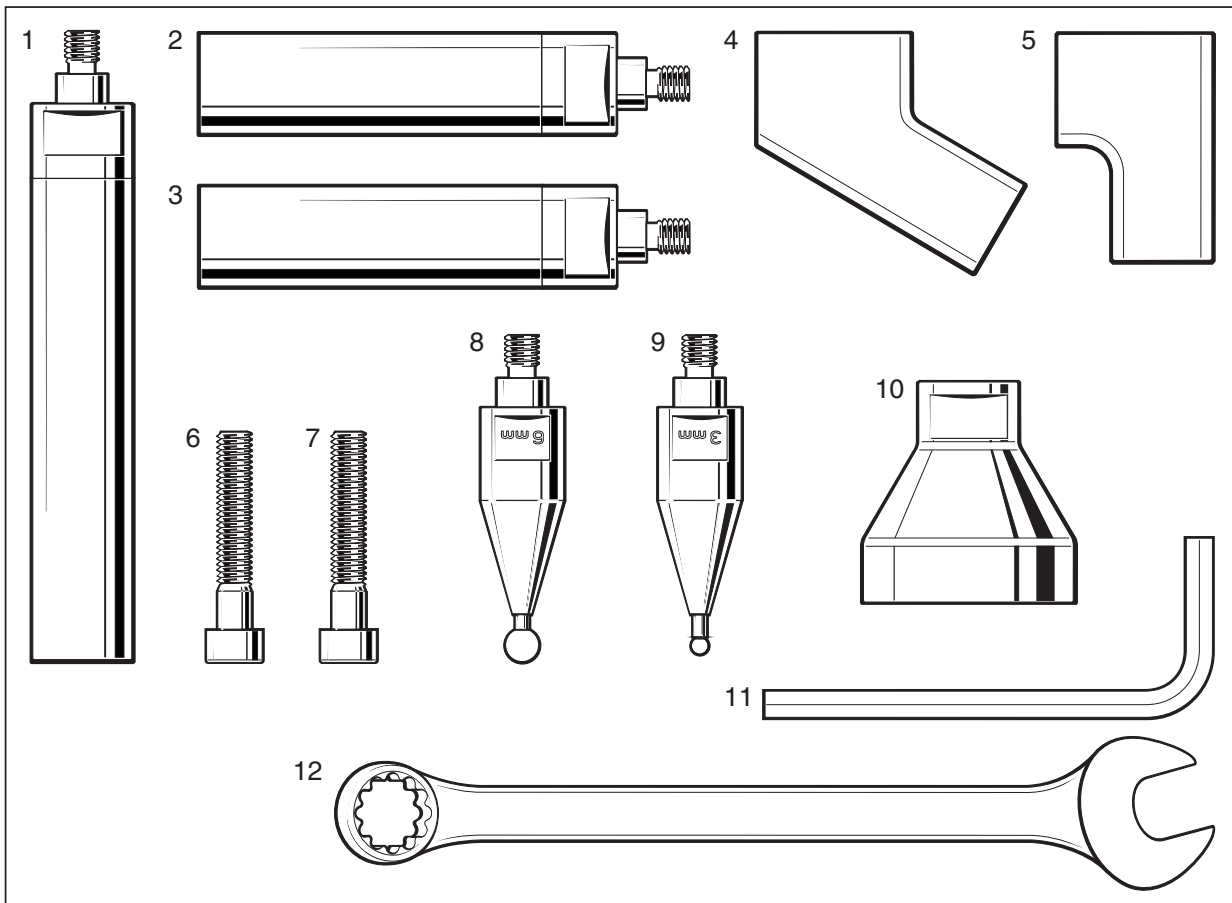



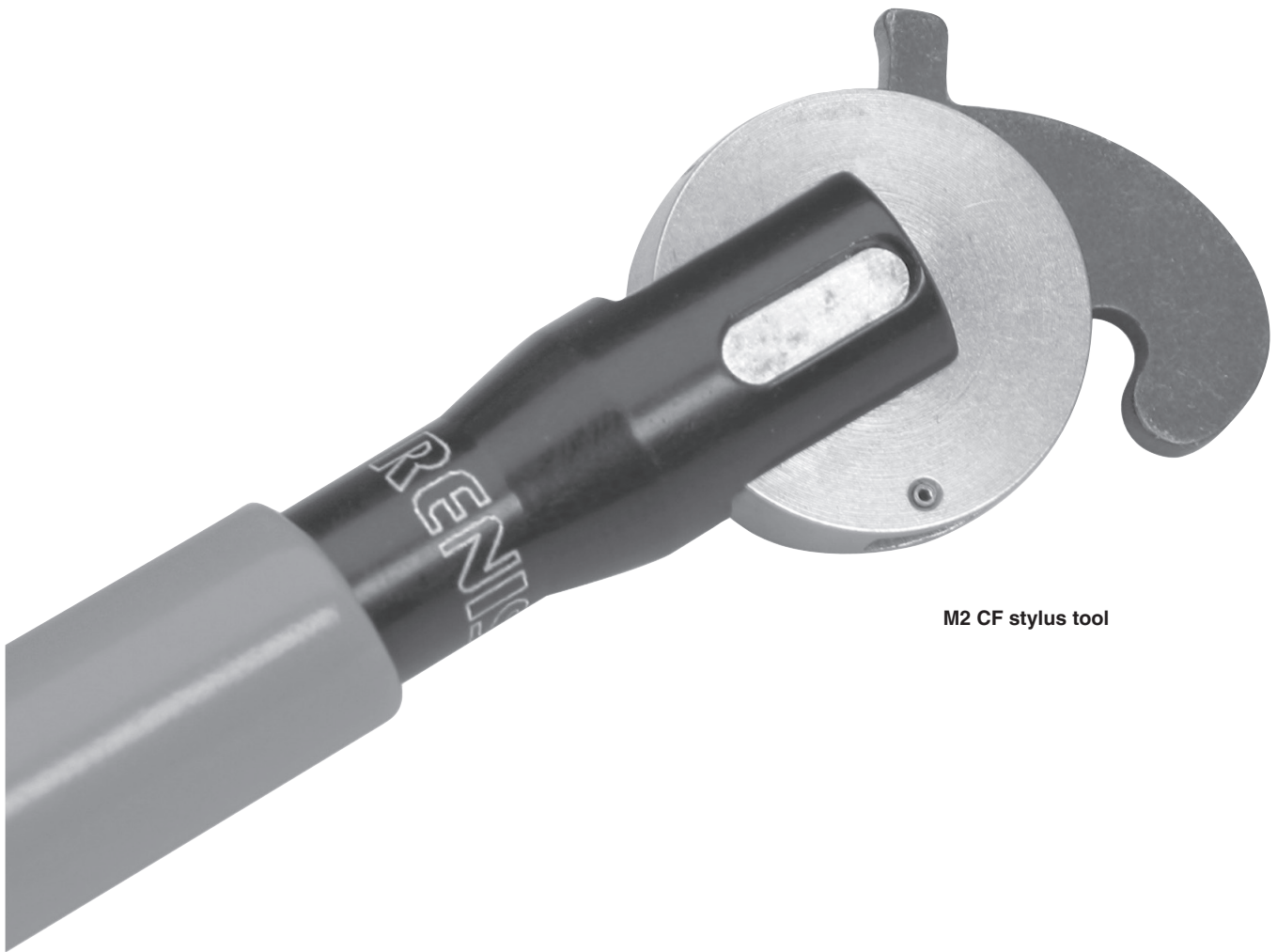

Position	Part number	Description
1	A-5003-9127	M6M - M6F EXT L101.6 (4.0) D18 AL
2 - 3	A-5003-9126	M6M - M6F EXT L76.2 (3.0) D18 AL
4	A-5003-9186	M6F FARO EXT 60 DEG ADAPTOR
5	A-5003-9187	M6F FARO EXT 90 DEG ADAPTOR
6 - 7	P-SC08-0635	SCREW HEX SKT CAPHD M6X35 STST
8	A-5003-7679	STYLUS M6 DIA 6 MM 21 PROBE 0067
9	A-5003-7678	STYLUS M6 DIA 3 MM 21 PROBE 0065
10	M-5003-9133	FARO ADAPTOR 1.25-20 UN-M6
11	P-TL01-0500	SKT WRENCH 5 MM A/F
12	P-TL09-0012	12 MM A/F OPEN/RING SPANNER

Accessories



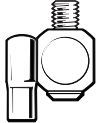

M2 CF stylus tool

Stylus knuckles

Part number	A-5000-7534*	A-5003-4697	A-5000-9902 Rotary	A-5000-7616*	A-5003-4686 Rotary
Thread size	M2	M2	M2	M3	M3
Effective length mm (in.)	8.0 (0.32)	13.5 (0.54)	16.5 (0.65)	12.0 (0.48)	17.0 (0.67)
Centre offset mm (in.)	4.5 (0.18)	N/A	N/A	6.0 (0.24)	N/A
Mass grammes	1.6	1.1	1.3	3.7	1.5
					

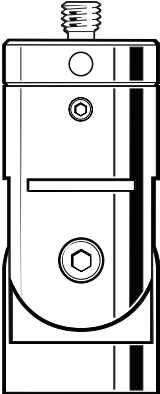

* M2 screw kit available to order A-5004-4447

* M3 screw kit available to order A-5004-7403

Part number	A-5003-4689 Rotary	A-5003-5278** Rotary	A-5003-5279 Rotary
Thread size	M4	M5	M5
Effective length mm (in.)	33.0 (1.30)	36.5 (1.44)	46.5 (1.84)
Centre offset mm (in.)	N/A	N/A	N/A
Mass grammes	9.8	16.5	64.9
			



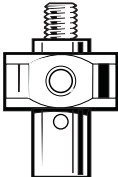

**Not for use with SP80

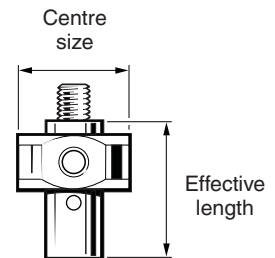



Stylus centres

Part number	A-5000-8395 4-way	A-5000-3627 5-way	A-5000-7610 5-way	A-5000-7792 5-way
Thread size	M2	M2	M3	M4
Effective length mm (in.)	7.5 (0.30)	7.5 (0.30)	13.0 (0.52)	18.0 (0.71)
Centre size mm (in.)	7.5 (0.30)	7.0 (0.28)	10.0 (0.40)	15.0 (0.60)
Mass grammes	1.1	0.8	3.6	12.1
				

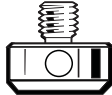
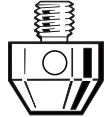
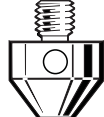

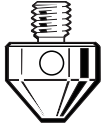
Adaptors

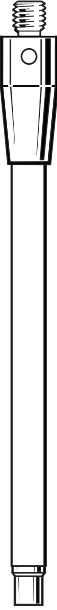
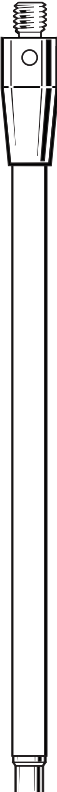
Part number	A-5004-7593 Stainless steel	A-5004-7592 Stainless steel	A-5004-7595 Stainless steel	A-5004-7597 Stainless steel	A-5004-7596 Stainless steel	A-5004-7613 Stainless steel	A-5003-0856 Stainless steel	A-5555-0227 Stainless steel
Male/female thread	M2/M3	M3/M2	M4/M2	M4/M3	M4/M3	M5/M4	M5/M4	M5/M3
Length mm (in.)	7.0 (0.28)	5.0 (0.20)	5.0 (0.20)	9.0 (0.36)	20.0 (0.79)	6.5 (0.26)	9.0 (0.36)	10.0 (0.40)
Mass grammes	0.4	0.6	1.5	1.4	3.2	6.0	4.6	5.0
								

Part number	A-5555-0226 Stainless steel	A-5000-7751 Ceramic	A-5004-7612 Stainless steel	A-5000-7752 Ceramic	A-5000-7753 Ceramic	A-2054-6350 Stainless steel
Male/female thread	M5/M2	M4/M3	TF6/M3	M4/M3	M4/M3	M4/Ø4.5
Length mm (in.)	10.0 (0.40)	50.0 (1.97)	18.0 (0.71)	75.0 (2.96)	100.0 (3.94)	10.0 (0.40)
Mass grammes	5.0	4.4	1.9	5.2	6.3	5.0
						

Cubes and bolts

Part number	A-5555-0189* Titanium	A-5555-0190* Titanium	A-5555-0194* Titanium	A-5003-5683* Titanium	A-5003-5684* Titanium
Thread size	M5	M5	M5	M5 – M2	M5 – M2
Length mm (in.)	15.0 (0.60)	20.0 (0.79)	20.0 (0.79)	15.0 (0.60)	20.0 (0.79)
Width mm (in.)	15.0 (0.60)	20.0 (0.79)	40.0 (1.58)	15.0 (0.60)	20.0 (0.79)
Mass grammes	12.85	32.55	63.50	13.75	35.18

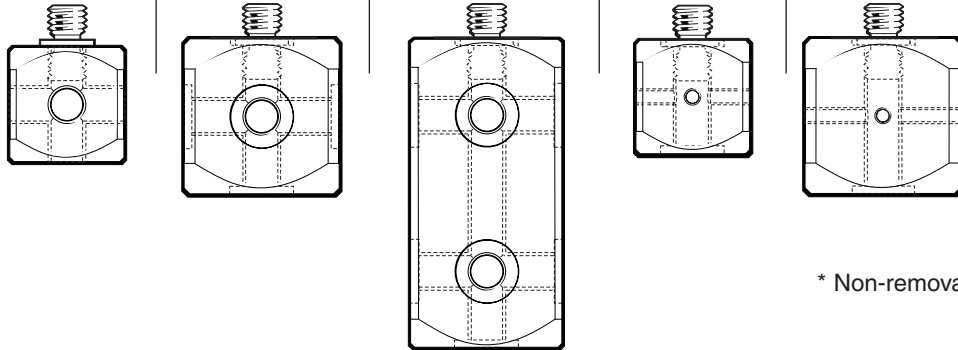

* Non-removable male thread

Part number	A-5003-5679 Stainless steel	A-5003-5678 Stainless steel	A-5003-5677 Stainless steel	A-5003-5676 Stainless steel
Thread size	M5 – M2	M5 – M2	M5	M5
Length mm (in.)	28.0 (1.11)	33.0 (1.30)	28.0 (1.11)	33.0 (1.30)
Mass grammes	6.7	7.1	6.0	6.4

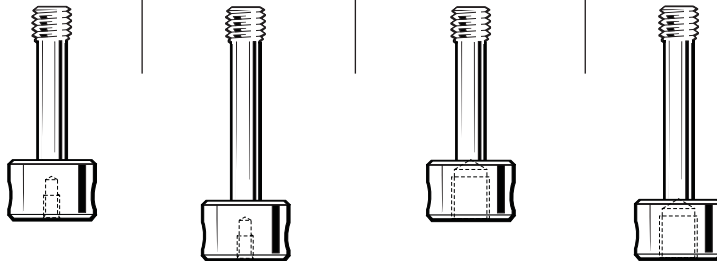

Styli tools

A-5004-7582
For M2 and M3
threaded styli

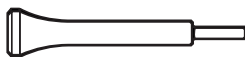

A-5004-7587
For M4
threaded styli



A-5004-7614
For M5
threaded styli

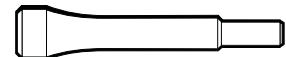

A-5003-2300
For the M2 carbon fibre
range of styli

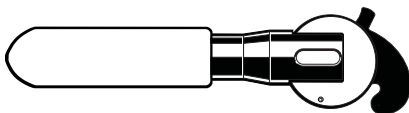

This tool is to be used exclusively to tighten all M2 carbon fibre extensions. The tool has been designed to tighten the extensions to the correct torque value & will click when value has been reached. Do not overtighten past the click as this could potentially damage the component you are tightening.

These tools are designed to fit styli to Renishaw probes without causing internal damage

M2 styli kits

A-5000-0002 M2 stylus enhancement kit

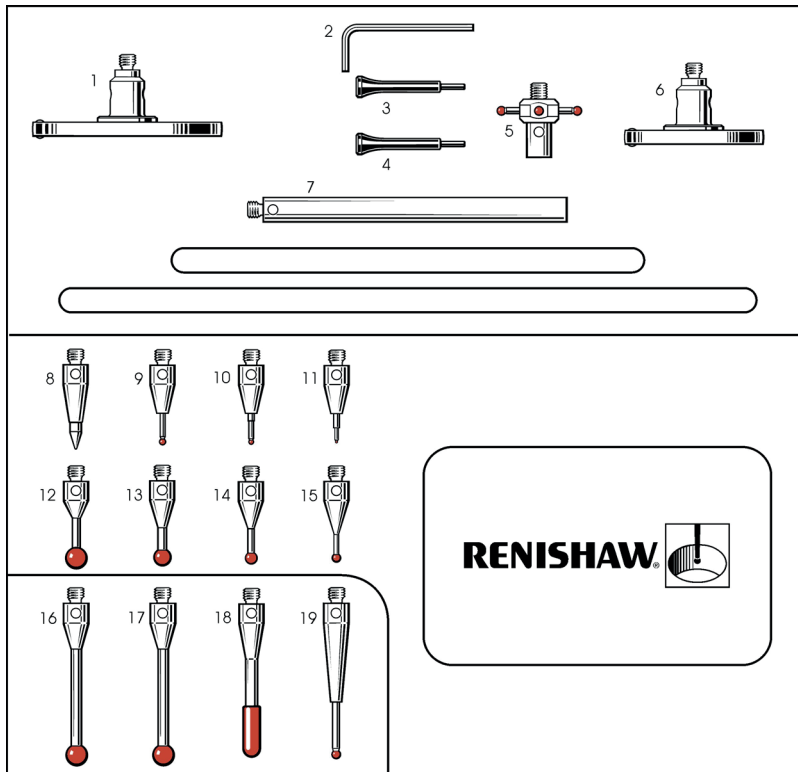

Position	Part number	Description
1	A-5000-7810	M2 DSC D25SLVS T1.5 L8.6 BR-Y2.5
2	P-TL01-0150	S3 HEX WRENCH 1.5 MM A/F
3-4	A-5004-7582	M2-M3 STYLUS TOOL
5	A-5000-7811	M2 STR D1R 4BALL L7.5T S10
6	A-5000-7809	M2 DSC D18SLVS T1.5 L8.6 BR-Y2.5
7	A-5004-7611	M2 EXT L40 d3SS
8	A-5000-7813	M2 PNT D1.4TC 30deg L10
9	A-5000-7801	M2 STY D0.7R L10 EWL4 d0.5TC
10	A-5000-7805	M2 STY D0.5R L10 EWL3 d0.4TC
11	A-5000-7800	M2 STY D0.3R L10 EWL2 d0.2TC
12	A-5000-7803	M2 STY D2.5R L10 EWL6.5 d1SS
13	A-5000-7807	M2 STY D2R L10 EWL6 d1SS
14	A-5000-7802	M2 STY D1.5R L10 EWL4.5 d0.7SS
15	A-5000-7806	M2 STY D1R L10 EWL4.5 d0.7SS
16-17	A-5000-7804	M2 STY D2.5R L20 EWL16.4 d1.4SS
18	A-5000-7812	M2 SPH D2R L20 EWL7.2 SS
19	A-5000-7808	M2 STY D1R L20 EWL7 d0.7TC

A-5003-2310 M2 high performance kit

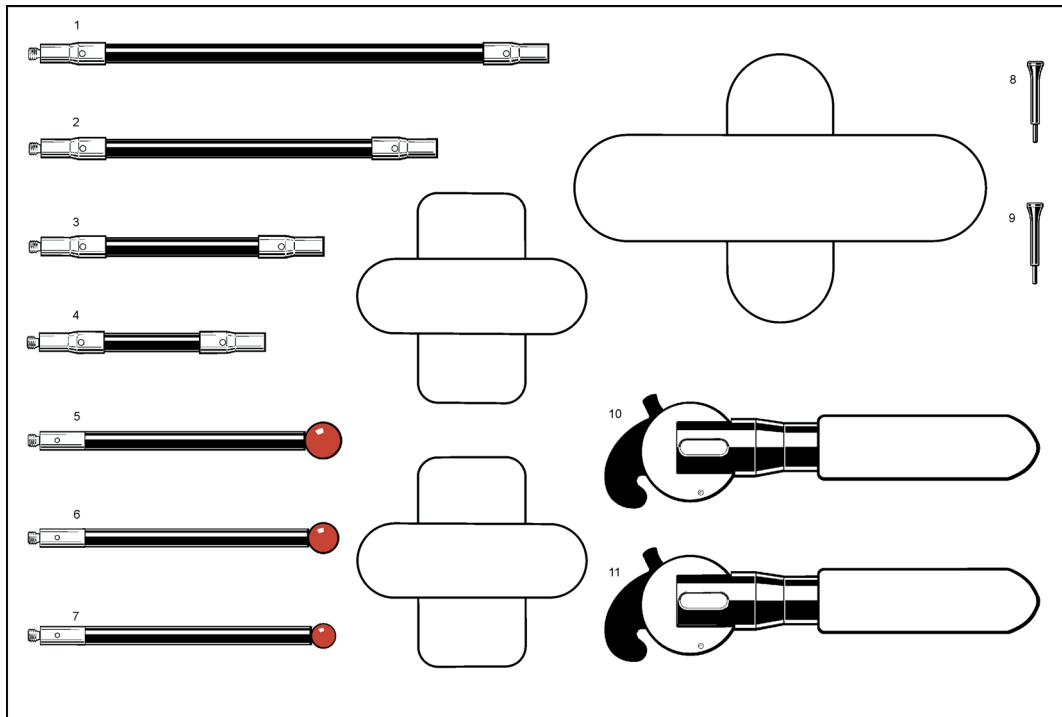

Position	Part number	Description
1	A-5003-2283	M2 EXT L90 d3CF
2	A-5003-2282	M2 EXT L70 d3CF
3	A-5003-2281	M2 EXT L50 d3CF
4	A-5003-2280	M2 EXT L40 d3CF
5	A-5003-2287	M2 STY D6R L50 EWL50 d3CF
6	A-5003-2286	M2 STY D5R L50 EWL50 d3CF
7	A-5003-2285	M2 STY D4R L50 EWL50 d3CF
8-9	A-5004-7582	M2-M3 STYLUS TOOL
10-11	A-5003-2300	M2 STYLUS TOOL CF RANGE

A-5000-0001 M2 comprehensive stylus kit

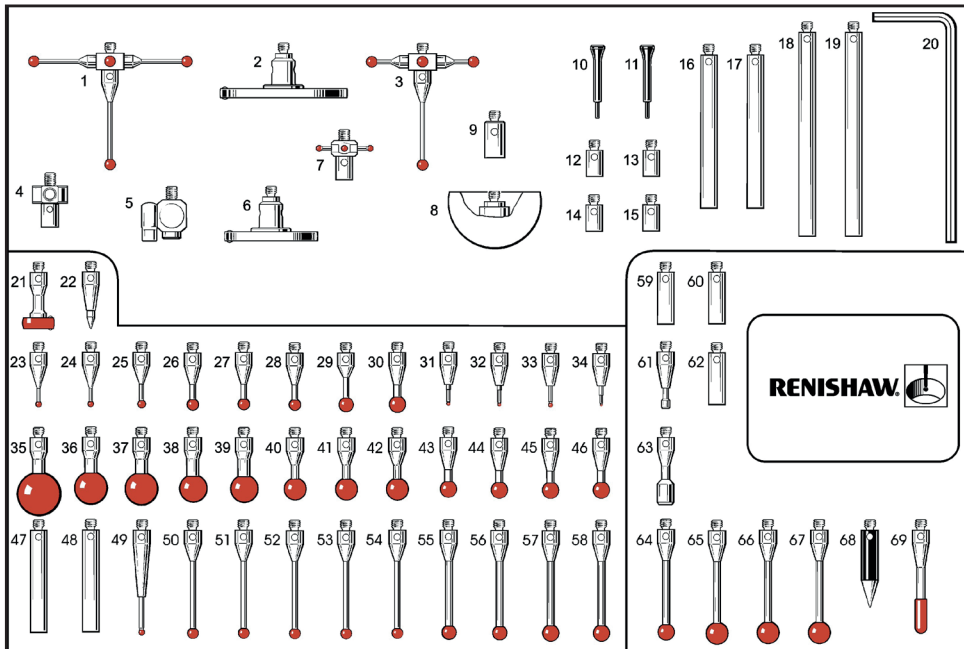

Position	Part number	Description
1	A-5000-3626	M2 STR D2R 5BALL L19.2 S30
2	A-5000-7810	M2 DSC D25SLVS T1.5 L8.6 BR-Y2.5
3	A-5000-7629	M2 STR D2R 5BALL L19.2 S18
4	A-5000-3627	M2 ACC CENTRE 5WAY
5	A-5000-7534	M2 ACC KNUCKLE OFFSET
6	A-5000-7809	M2 DSC D18SLVS T1.5 L8.6 BR-Y2.5
7	A-5000-7811	M2 STR D1 4BALL L7.5 S10
8	A-5000-3614	M2 HEM D18CE
9	A-5004-7593	M2-M3 EXT L7SS
10-11	A-5004-7582	M2-M3 STYLUS TOOL
12-15	A-5004-7610	M2 EXT L5 d3SS
16-17	A-5004-7591	M2 EXT L30 d3SS
18-19	A-5004-7611	M2 EXT L40 d3SS
20	P-TL01-0150	S3 HEX WRENCH 1.5 MM A/F
21	A-5000-3611	M2 DSC D6R T1.2 L10 BR-Y2
22	A-5000-7813	M2 PNT D1.4TC 30deg L10
23-24	A-5000-7806	M2 STY D1R L10 EWL4.5 d0.7SS
25	A-5000-7802	M2 STY D1.5R L10 EWL4.5 d0.7SS
26-28	A-5000-7807	M2 STY D2R L10 EWL6 d1SS
29	A-5000-7803	M2 STY D2.5R L10 EWL6 d1SS
30	A-5000-3604	M2 STY D3R L10 EWL7.5 d1.5SS
31-32	A-5000-7805	M2 STY D0.5R L10 EWL3 d0.4TC
33	A-5000-7801	M2 STY D0.7R L10 EWL4 d0.5TC
34	A-5000-7800	M2 STY D0.3R L10 EWL2 d0.2TC
35	A-5000-4158	M2 STY D8R L11 EWL11 d2.5SS
36-37	A-5000-4156	M2 STY D6R L10 EWL10 d2.5SS
38-39	A-5000-4155	M2 STY D5R L10 EWL10 d2.5SS
40-42	A-5000-4154	M2 STY D4R L10 EWL10 d1.5SS
43-46	A-5000-3604	M2 STY D3R L10 EWL7 d1.5SS
47-48	A-5004-7586	M2 EXT L20 d3SS
49	A-5000-7808	M2 STY D1R L20 EWL7 d0.7TC
50-54	A-5000-3603	M2 STY D2R L20 EWL14 d1.4SS
55-56	A-5000-7804	M2 STY D2.5R L20 EWL16.4 d1.4SS
57-58	A-5000-4160	M2 STY D3R L20 EWL17 d1.5SS
59-60	A-5004-7585	M2 EXT L10 d3SS
61	A-5004-7589	M2 CYL D1.5SLVS L11 EWL1.25
62	A-50047585	M2 EXT L10 d3SS
63	A-5004-7590	M2 CYL D3SLVS L13 EWL3.8
64	A-5000-4160	M2 STY D3R L20 EWL17 d1.5SS
65-67	A-5000-4161	M2 STY D4R L20 EWL20 d1.5SS
68	A-5004-7588	M2 PNT D3SLVS 30deg L15
69	A-5000-7812	M2 SPH D2R L20 EWL7.2 SS

M2 styli kits

A-5004-5131 M2 stylus starter kit

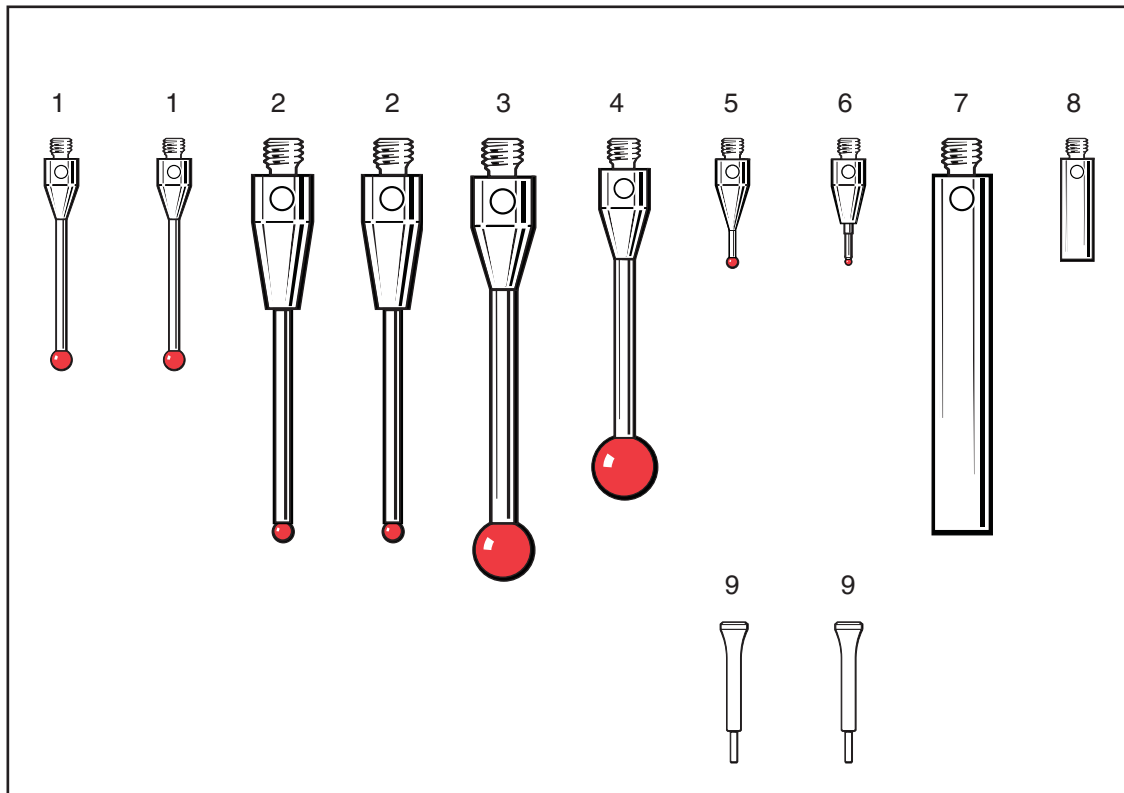

Position	Part number	Description
1	A-5003-3603	M2 STY D2R L20 EWL14 d1.4SS
2	A-5003-0033	M2 STY D1R L20 EWL12.5 d0.8TC
3	A-5000-4160	M2 STY D3R L20 EWL17 d1.5SS
4	A-5000-4161	M2 STY D4R L20 EWL20 d1.5SS
5	A-5000-7806	M2 STY D1R L10 EWL4.5 d0.7SS
6	A-5000-7805	M2 STY D0.5R L10 EWL3 d0.4TC
7	A-5004-7586	M2 EXT L20 d3SS
8	A-5004-7585	M2 EXT L10 d3SS
9	A-5004-7582	M2-M3 STYLUS TOOL

M3 styli kits

A-5004-6880 M3 stylus starter kit

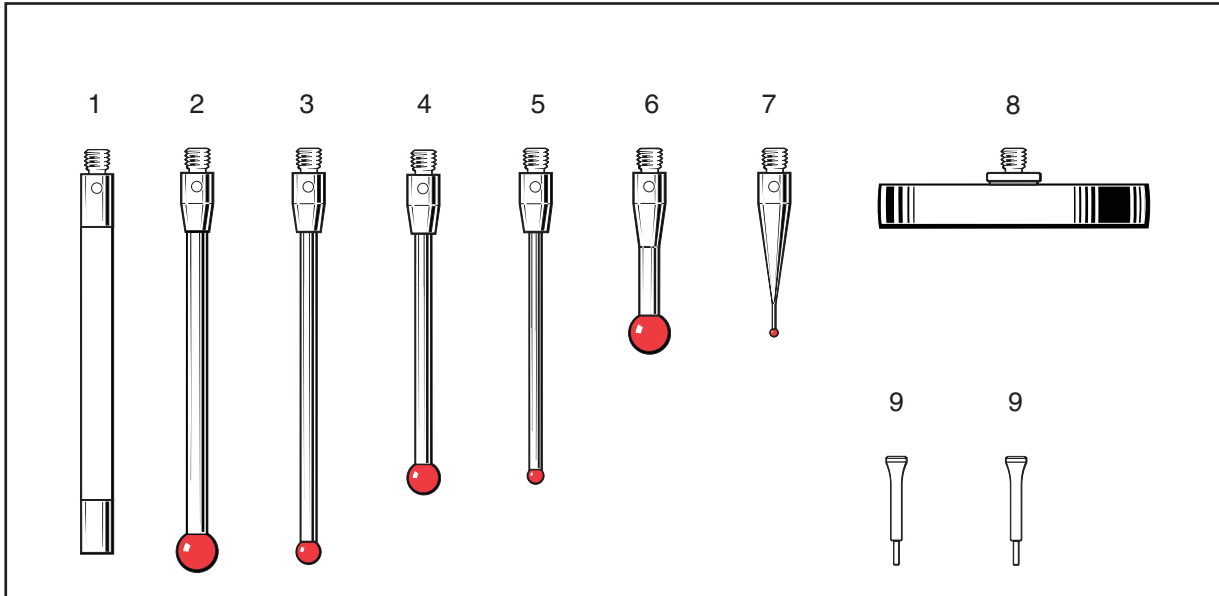

Position	Part number	Description	Position	Part number	Description
1	A-5003-0075	M3 EXT L50 d4CE	6	A-5000-7630	M3 STY D5R L21 EWL21 d2.5SS
2	A-5003-0069	M3 STY D5R L50 EWL50 d2.5CE	7	A-5000-3551	M3 STY D1R L21 EWL4 d0.7SS
3	A-5003-0059	M3 STY D3R L50 EWL43.7 d2TC	8	A-5000-7612	M3 DSC D35SLVS T5 L3.5 BR-N
4	A-5003-0060	M3 STY D4R L40 EWL36 d2TC	9	A-5004-7582	M2-M3 STYLUS TOOL
5	A-5003-0053	M3 STY D2R L40 EWL32.5 d1.5TC			

www.renishaw.com

A-5003-6151 M3 stylus kit for SP25M/SM25-1/SH25-1

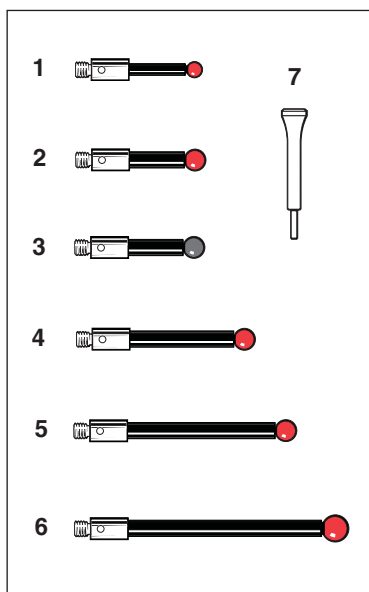

Position	Part number	Description
1	A-5003-5970	M3 STY D3R L21 EWL13.5 d2CF
2	A-5003-5971	M3 STY D4R L21 EWL13.5 d3CF
3	A-5003-5977	M3 STY D4SN L21 EWL13.5 d3CF
4	A-5003-5972	M3 STY D4R L31 EWL23.5 d3CF
5	A-5003-5973	M3 STY D4R L40 EWL32.5 d3CF
6	A-5003-5974	M3 STY D5R L50 EWL42.5 d3CF
7	A-5004-7582	M2-M3 STYLUS TOOL

www.renishaw.com

M3 styli kits

A-5003-6152 M3 stylus kit for SP25M/SM25-2/SH25-2

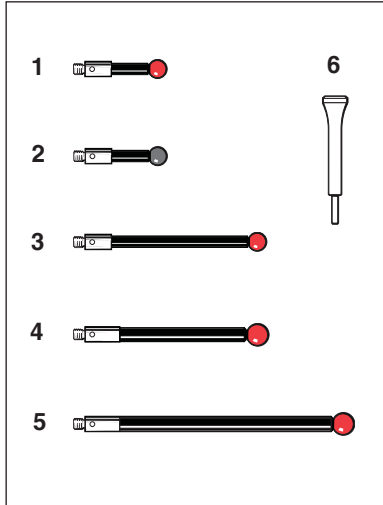

Position	Part number	Description
1	A-5003-5975	M3 STY D5R L21 EWL13.5 d3CF
2	A-5003-5978	M3 STY D5SN L21 EWL13.5 d3CF
3	A-5003-5974	M3 STY D5R L50 EWL42.5 d3CF
4	A-5003-5976	M3 STY D6R L50 EWL50 d4CF
5	A-5003-4860	M3 STY D6R L75 EWL75 d4CF
6	A-5004-7582	M2-M3 STYLUS TOOL

www.renishaw.com

A-5003-6153 M3 stylus kit for SP25M/SM25-3/SH25-3

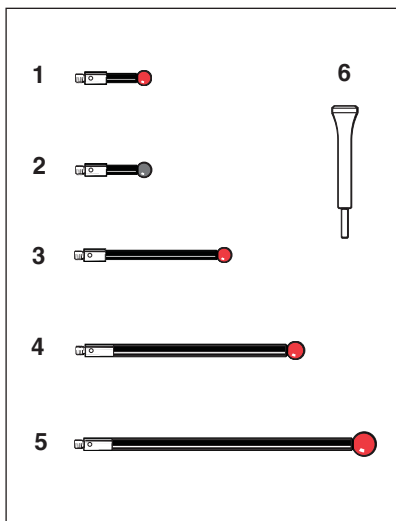

Position	Part number	Description
1	A-5003-5975	M3 STY D5R L21 EWL13.5 d3CF
2	A-5003-5978	M3 STY D5SN L21 EWL13.5 d3CF
3	A-5003-5974	M3 STY D5R L50 EWL42.5 d3CF
4	A-5003-4860	M3 STY D6R L75 EWL75 d4CF
5	A-5003-4863	M3 STY D8R L100 EWL100 d4CF
6	A-5004-7582	M2-M3 STYLUS TOOL

www.renishaw.com

M4 styli kits

A-5000-7829 M4 stylus kit (TP7M use)

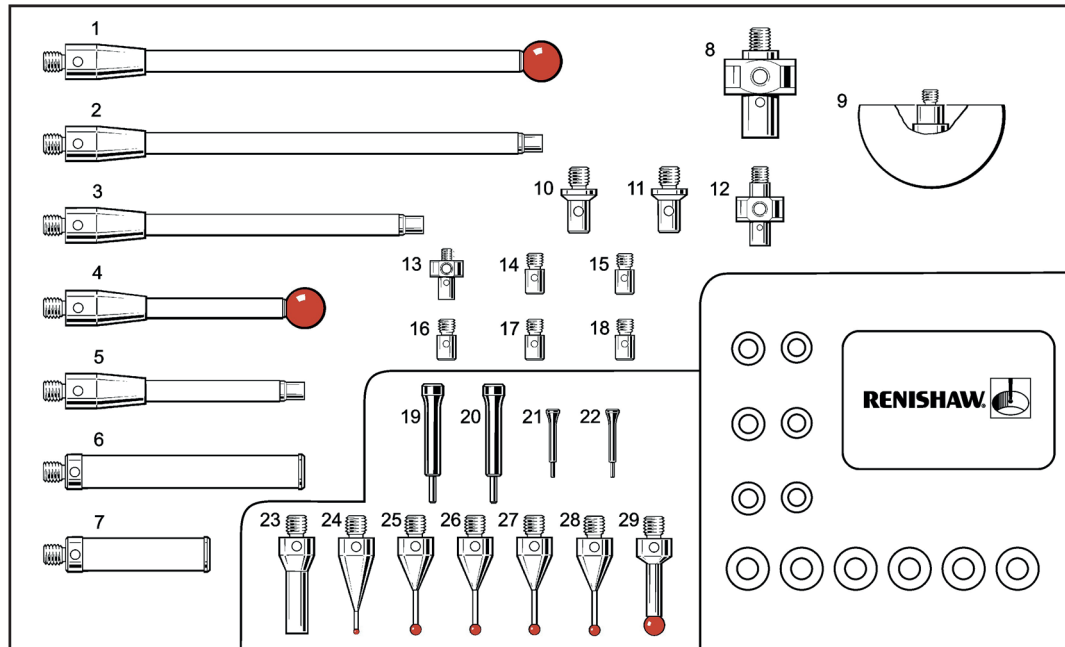

Position	Part number	Description
1	A-5000-7796	M4 STY D8R L100 EWL100 d4.5CE
2	A-5000-7753	M4-M3 EXT L100CE
3	A-5000-7752	M4-M3 EXT L75CE
4	A-5000-7795	M4 STY D8R L50 EWL50 d4.5CE
5	A-5000-7751	M4-M3 EXT L50CE
6	A-5000-7755	M4 EXT L50 d7.4CE
7	A-5000-7754	M4 EXT L30 d7.4CE
8	A-5000-7792	M4 ACC CENTRE 5WAY
9	A-5000-7814	M3 HEM D30CE
10-11	A-5004-7597	M4-M3 EXT L9SS
12	A-5000-7610	M3 ACC CENTRE 5WAY
13	A-5000-3627	M2 ACC CENTRE 5WAY
14-18	A-5004-7592	M3-M2 EXT L5SS
19-20	A-5004-7587	M4 STYLUS TOOL
21-22	A-5004-7582	M2-M3 STYLUS TOOL
23	A-5004-7596	M4-M3 EXT L20SS
24	A-5000-7545	M4 STY D1R L19.5 EWL4.5 d0.7SS
25-28	A-5000-7547	M4 STY D2R L19 EWL9.2 d1.4SS
29	A-5000-7551	M4 STY D4R L18 EWL13.7 d3SS

M4 styli kits

A-5004-5132 M4 stylus starter kit

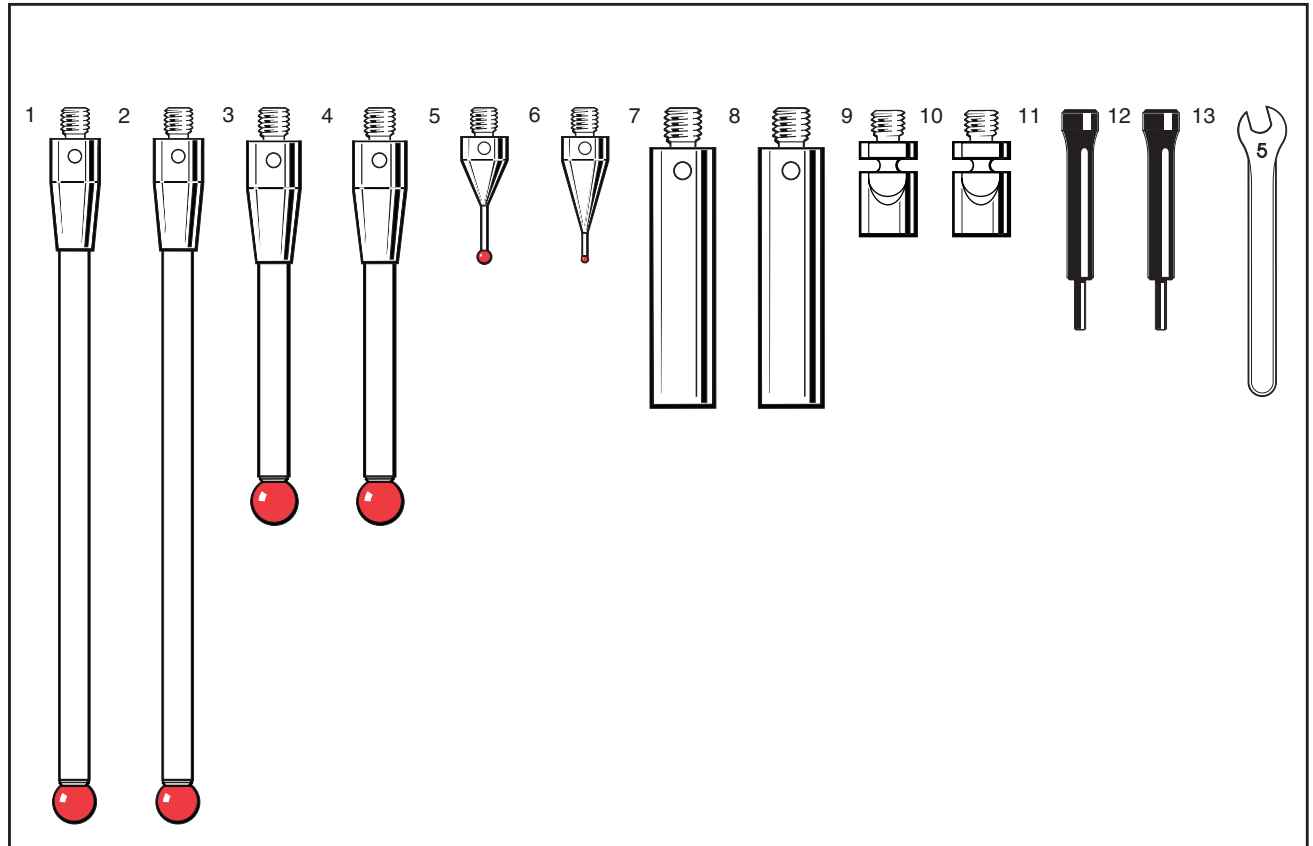

Position	Part number	Description
1-2	A-5000-3712	M4 STY D6R L100 EWL88.5 d4.5CE
3-4	A-5000-3709	M4 STY D6R L50 EWL38.5 d4.5CE
5	A-5000-7547	M4 STY D2R L19 EWL9.2 d1.4SS
6	A-5000-7545	M4 STY D1R L19.5 EWL4.5 d0.7SS
7-8	A-5004-7602	M4 EXT L30 d7SS
9-10	A-5004-7621	M4 CPD L12SLVS
11-12	A-5004-7587	M4 STYLUS TOOL
13	P-TL09-0003	SPANNER 5 MM A/F

M5 styli kits

A-5003-6168 M5 stylus kit SP80

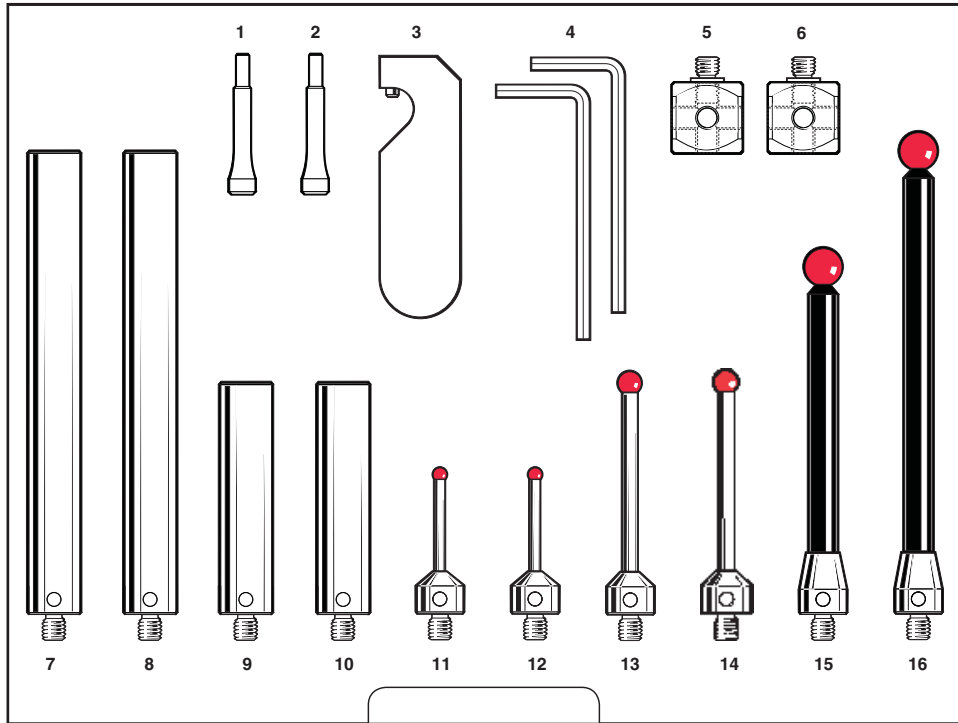

Position	Part number	Description
1-2	A-5004-7614	M5 STYLUS TOOL
3	A-5003-6134	M5 ACC D11 EXTENSION TOOL
4	P-TL01-0250	S3 HEX WRENCH 2.5 MM A/F
5-6	A-5555-0189	M5 ACC 15x15 CUBE
7-8	A-5555-0136	M5 EXT L100 d11SS
9-10	A-5555-0670	M5 EXT L50 d11SS
11-12	A-5003-5218	M5 STY D3R L30 EWL21 d2TC
13-14	A-5003-5236	M5 STY D5R L50 EWL41 d3TC
15	A-5003-5251	M5 STY D8R L75 EWL62 d6CF
16	A-5003-5262	M5 STY D8R L100 EWL87 d6CF

A-5003-5911 M5 stylus kit – standard

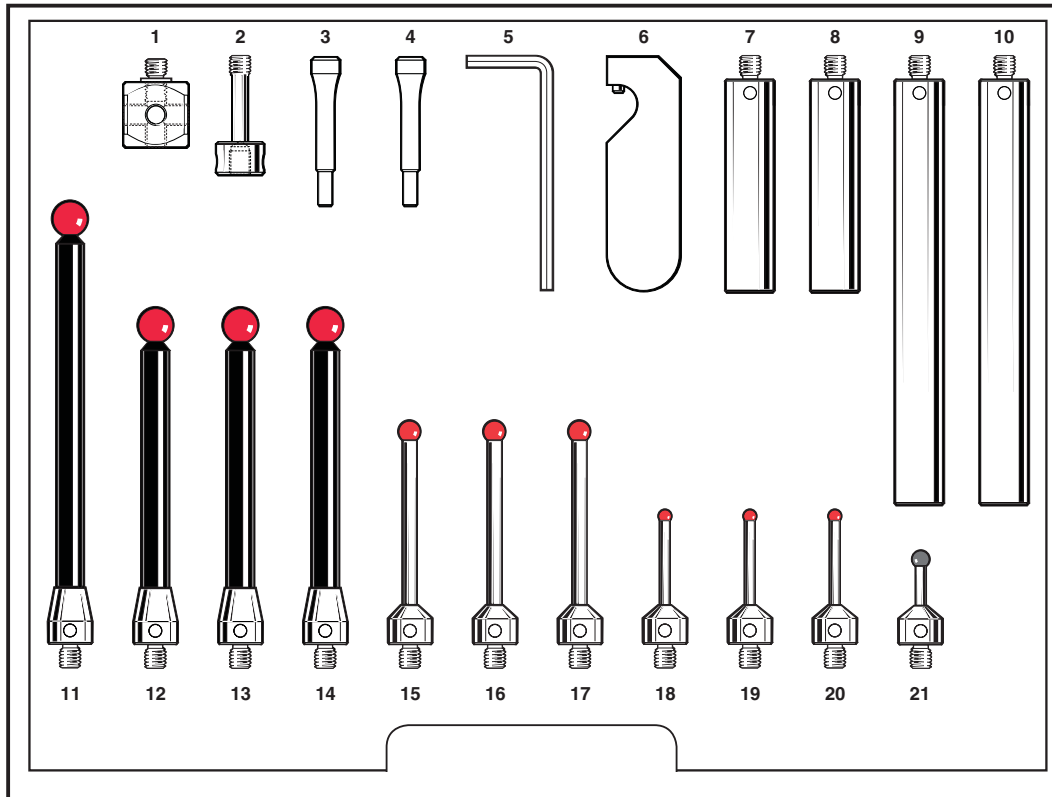

Position	Part number	Description
1	A-5555-0189	M5 ACC 15x15 CUBE
2	A-5003-5677	M5 ACC CUBE BOLT L28
3-4	A-5004-7614	M5 STYLUS TOOL
5	P-TL01-0250	S6 HEX WRENCH 2.5 MM A/F
6	A-5003-6134	M5 ACC D11 EXTENSION TOOL
7-8	A-5555-0670	M5 EXT L50 d11SS
9-10	A-5555-0136	M5 EXT L100 d11SS
11	A-5003-5262	M5 STY D8R L100 EWL89.5 d6CF
12-14	A-5003-5251	M5 STY D8R L75 EWL64.5 d6CF
15-17	A-5003-5236	M5 STY D5R L50 EWL41.5 d3TC
18-20	A-5003-5218	M5 STY D3R L30 EWL21 d2TC
21	A-5003-5733	M5 STY D4SN L20 EWL11.9 d2TC

A-5003-5909 M5 stylus kit – comprehensive

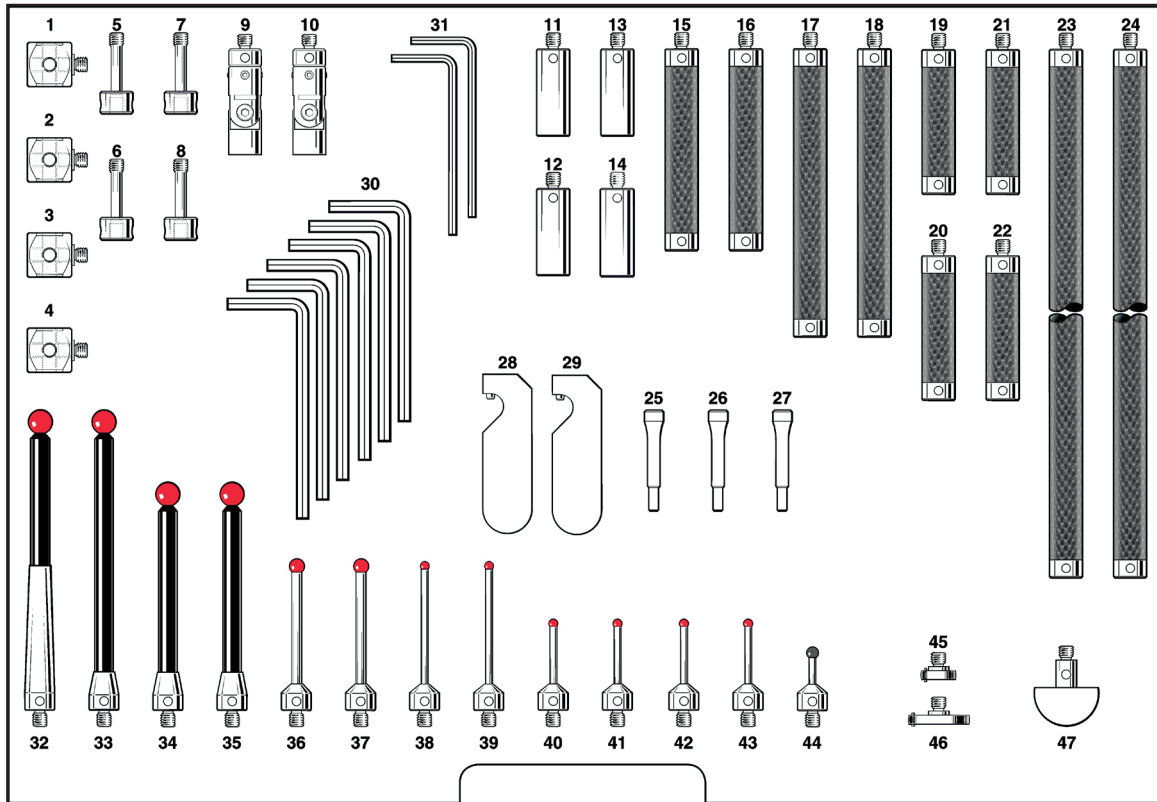

Position	Part number	Description
1-4	A-5555-0189	M5 ACC 15×15 CUBE
5-8	A-5003-5677	M5 ACC CUBE BOLT L28
9-10	A-5003-5278	M5 ACC KNUCKLE d11 ROTARY
11-14	A-5555-0669	M5 EXT L30 d11SS
15-16	A-5555-0623	M5 EXT L70 d11CF
17-18	A-5555-0652	M5 EXT L100 d11CF
19-22	A-5555-0648	M5 EXT L50 d11CF
23-24	A-5555-0654	M5 EXT L200 d11CF
25-27	A-5004-7614	M5 STYLUS TOOL
28-29	A-5003-6134	M5 ACC D11 EXTENSION TOOL
30	P-TL01-0250	S3 HEX WRENCH 2.5 MM A/F
31	P-TL01-0150	S3 HEX WRENCH 1.5 MM A/F
32	A-5003-5261	M5 STY D8R L100 EWL50 d6CF
33	A-5003-5262	M5 STY D8R L100 EWL89.5 d6CF
34-35	A-5003-5251	M5 STY D8R L75 EWL64.5 d6CF
36-37	A-5003-5236	M5 STY D5R L50 EWL41.5 d3TC
38-39	A-5003-5234	M5 STY D3R L50 EWL41 d2TC
40-43	A-5003-5218	M5 STY D3R L30 EWL21 d2TC
44	A-5003-5733	M5 STY D4SN L20 EWL11.9 d2TC
45	A-5003-5288	M5 DSC D12SLVS T3 L3 BR-Y5
46	A-5003-5289	M5 DSC D21SLVS T3 L3 BR-Y5
47	A-5003-5276	M5 HEM D22CE d7SS

A-5003-5910 M5 stylus kit - general purpose

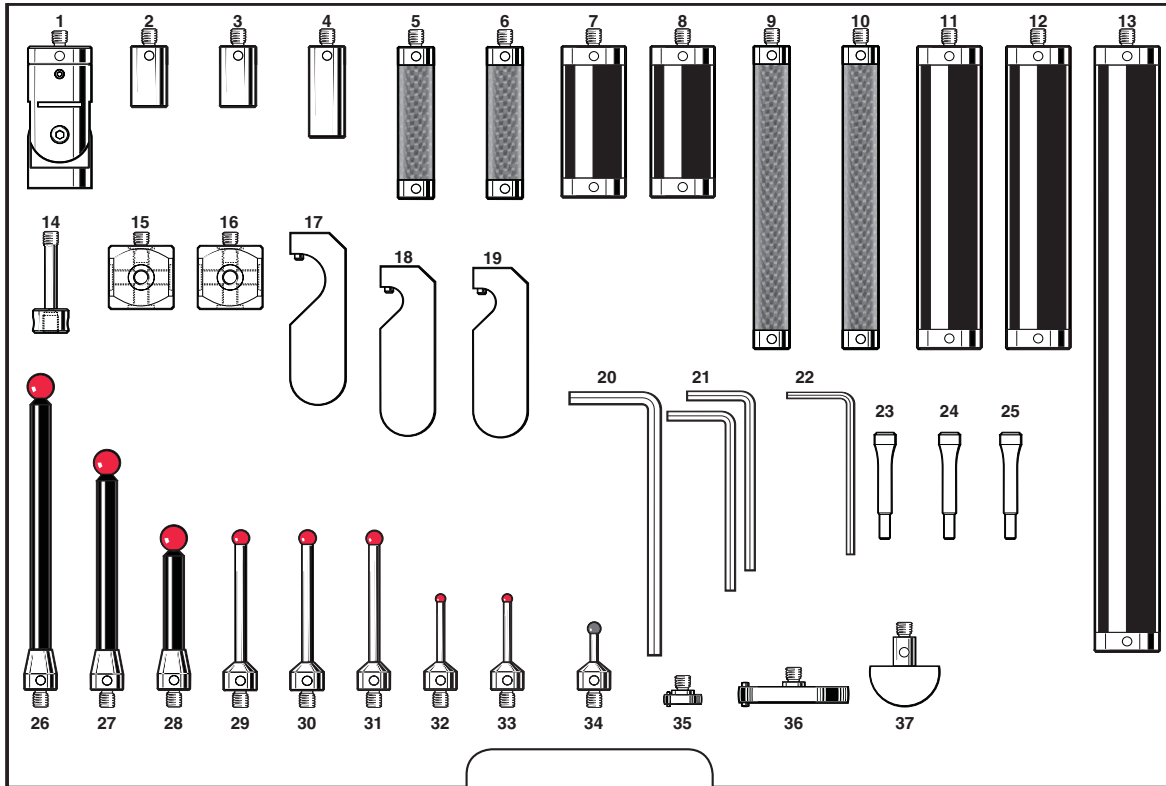

Position	Part number	Description
1	A-5003-5279	M5 ACC KNUCKLE d20 ROTARY
2-3	A-5555-0140	M5 EXT L20 d11SS
4	A-5555-0669	M5 EXT L30 d11SS
5-6	A-5555-0648	M5 EXT L50 d11CF
7-8	A-5555-0671	M5 EXT L50 d20AL
9-10	A-5555-0652	M5 EXT L100 d11CF
11-12	A-5555-0127	M5 EXT L100 d20AL
13	A-5555-0125	M5 EXT L200 d20AL
14	A-5003-5676	M5 ACC CUBE BOLT L33
15-16	A-5555-0190	M5 ACC 20x20 CUBE
17	A-5003-6135	M5 ACC D20 EXTENSION TOOL
18-19	A-5003-6134	M5 ACC D11 EXTENSION TOOL
20	P-TL01-0300	S4 HEX WRENCH 3.0 MM A/F
21	P-TL01-0250	S6 HEX WRENCH 2.5 MM A/F
22	P-TL01-0150	S3 HEX WRENCH 1.5 MM A/F
23-25	A-5004-7614	M5 STYLUS TOOL
26	A-5003-5262	M5 STY D8R L100 EWL89.5 d6CF
27	A-5003-5251	M5 STY D8R L75 EWL64.2 d6CF
28	A-5003-5238	M5 STY D8R L50 EWL39.5 d6CF
29-31	A-5003-5236	M5 STY D5R L50 EWL41.5 d3TC
32-33	A-5003-5218	M5 STY D3R L30 EWL21 d2TC
34	A-5003-5733	M5 STY D4SN L20 EWL11.9 d2TC
35	A-5003-5288	M5 DSC D12SLVS T3 L3 BR-Y5
36	A-5003-5290	M5 DSC D35SLVS T5 L4 BR-Y8
37	A-5003-5276	M5 HEM D22CE d7SS

A-5003-5912 M5 stylus extension kit – 11 mm

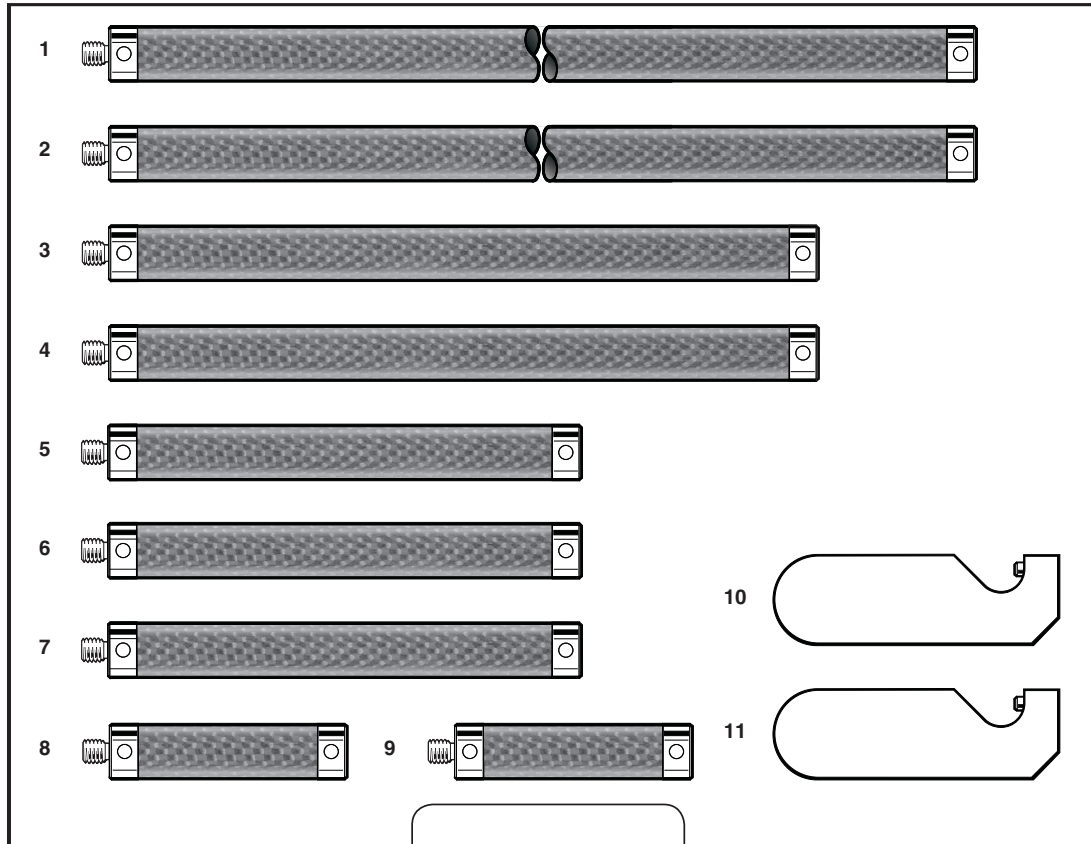

Position	Part number	Description
1-2	A-5555-0654	M5 EXT L200 d11CF
3-4	A-5555-0424	M5 EXT L150 d11CF
5-7	A-5555-0652	M5 EXT L100 d11CF
8-9	A-5555-0648	M5 EXT L50 d11CF
10-11	A-5003-6134	M5 ACC D11 EXTENSION TOOL

A-5003-5913 M5 stylus extension kit - 20 mm

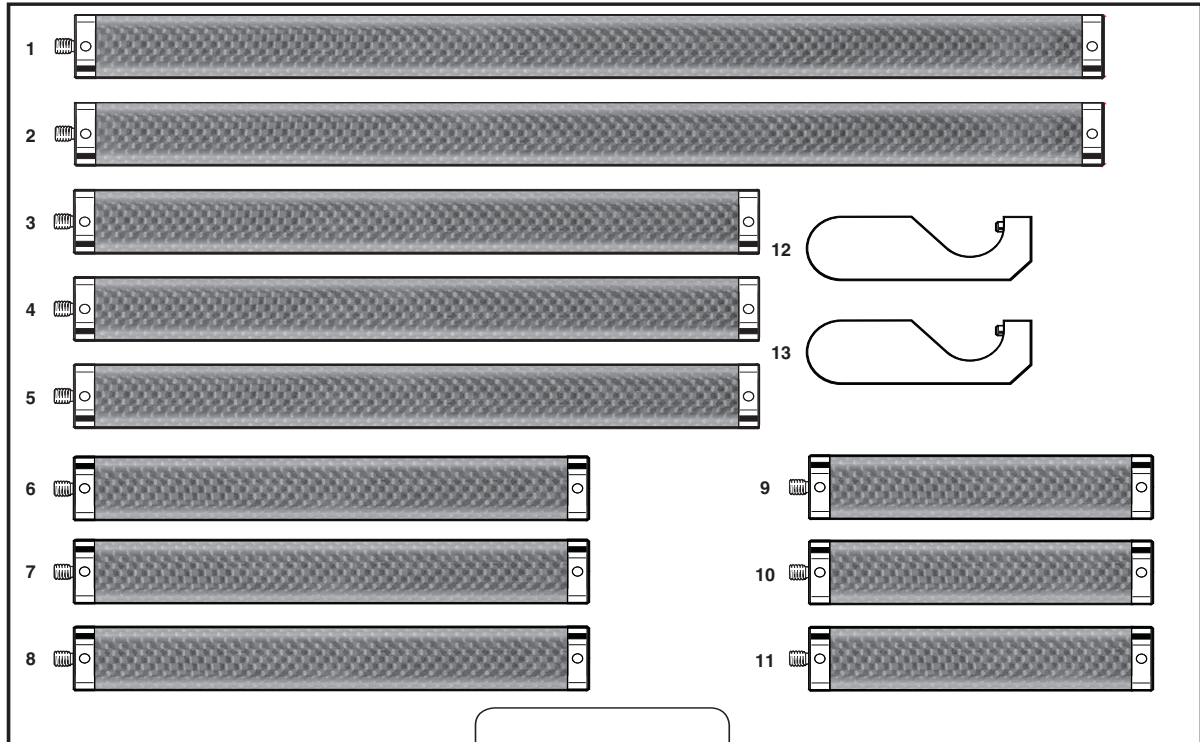

Position	Part number	Description
1-2	A-5555-0664	M5 EXT L300 d20CF
3-5	A-5555-0663	M5 EXT L200 d20CF
6-8	A-5555-0661	M5 EXT L150 d20CF
9-11	A-5555-0659	M5 EXT L100 d20CF
12-13	A-5003-6135	M5 ACC D20 EXTENSION TOOL

A-5504-0281 EQUATOR stylus kit-basic

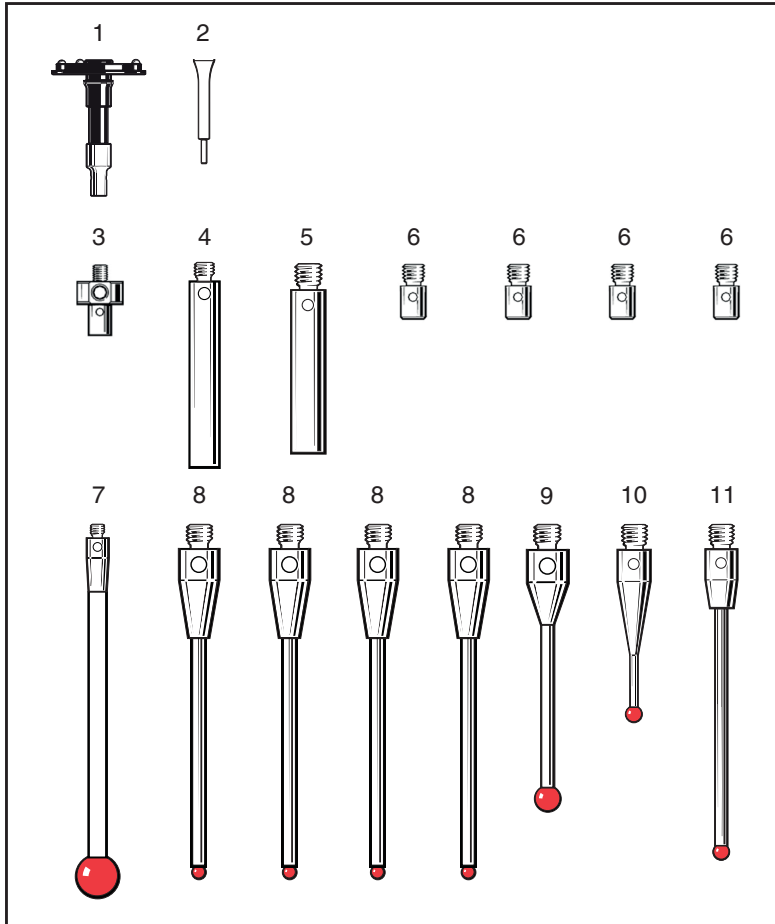

Position	Part number	Description
1	A-2237-1702	SH25-2A KIT
2	A-5004-7582	STYLUS TOOL D1.13/1.10
3	A-5000-3627	SC2 5-WAY CENTRE
4	A-5004-7586	SE5 STYLUS EXTENSION
5	A-5004-7583	SE2 STYLUS EXTENSION
6	A-5004-7592	SA3 STYLUS ADAPTOR
7	A-5003-0470	M2 STYLUS D6R L50 EWL50 d2.5CR
8	A-5000-8663	M2 STY D1R L27.5 EWL20.5 d0.7TC
9	A-5000-3603	M2 STY D2R EWL13.9 d1.4SS
10	A-5000-3552	M3 STY D2R L21 EWL11 d1.4SS
11	A-5003-0053	M3 STY D2R L40 EWL32,5 d1,5TC

A-5504-0282 EQUATOR stylus kit-intermediate

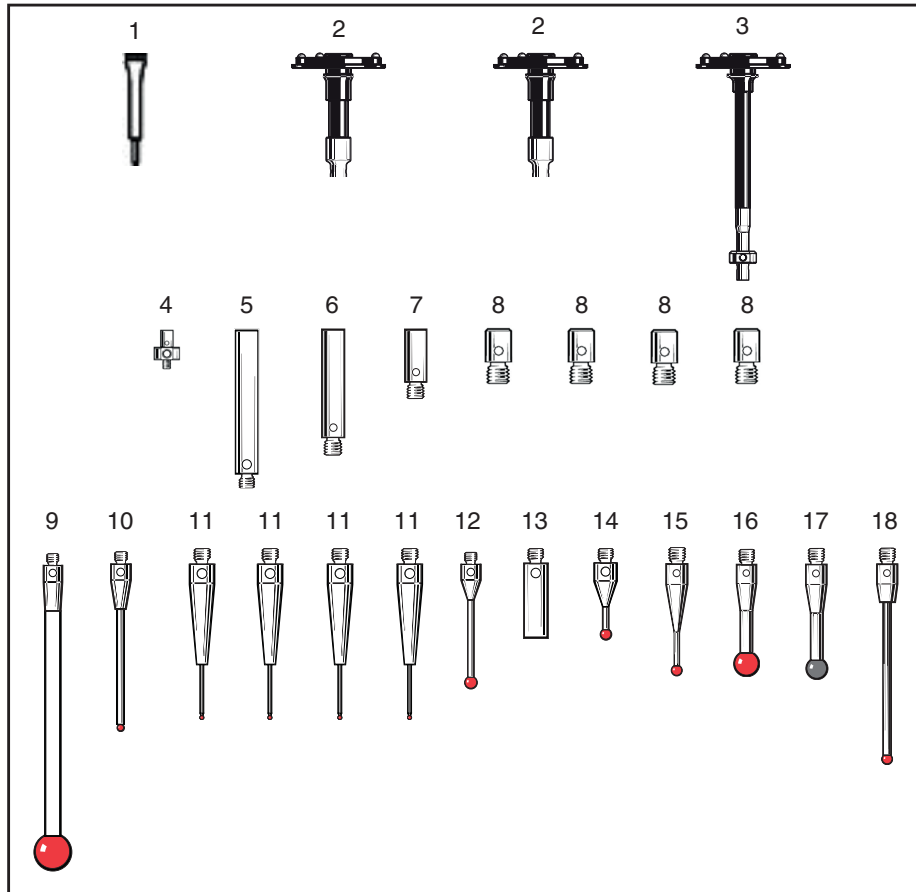

Position	Part number	SEDescription
1	A-5004-7582	STYLUS TOOL D1.13/1.10
2	A-2237-1702	SH25-2A KIT
3	A-5004-5101	SH25-2 STY L50 5 WAY CNTR
4	A-5000-3627	SC2 5-WAY CENTRE
5	A-5004-7586	SE5 STYLUS EXTENSION
6	A-5004-7583	SE2 STYLUS EXTENSION
7	A-5004-7609	SE8 STYLUS EXTENSION
8	A-5004-7592	SA3 STYLUS ADAPTOR
9	A-5003-0470	M2 STYLUS D6R L50 EWL50 d2.5CR

Position	Part number	SEDescription
10	A-5000-8663	M2 STY D1R L27.5 EWL20.5 d0.7TC
11	A-5003-1345	M2 STY D0.5R L20 EWL7 d0.34TC
12	A-5000-3603	M2 STY D2R EWL13.9 d1.4SS
13	A-5004-7585	SE4 STYLUS EXTENSION
14	A-5000-7802	M2 STY D1,5R L10 EWL5,4 d0,7SS
15	A-5000-3552	M3 STY D2R L21 EWL11 d1.4SS
16	A-5000-7630	M3 STY D5R L21 d2,5SS
17	A-5003-5061	M3 STY D4SiN L21 EWL21 D2.5SS
18	A-5003-0053	M3 STY D2R L40 EWL32,5 d1,5TC

A-5504-0283 EQUATOR stylus kit-advanced

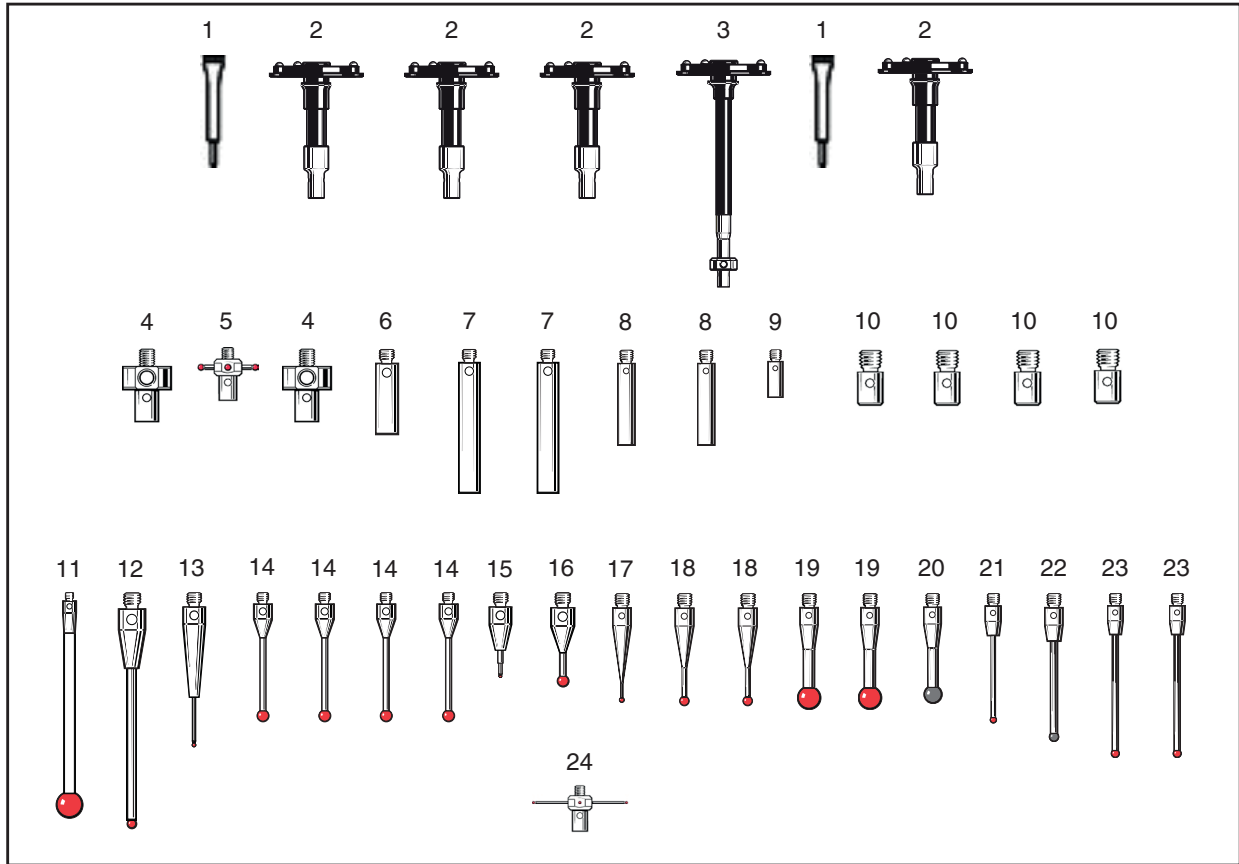

Position	Part number	Description
1	A-5004-7582	STYLUS TOOL D1.13/1.10
2	A-2237-1702	SH25-2A KIT
3	A-5004-5101	SH25-2 STY L50 5 WAY CNTR
4	A-5000-3627	SC2 5-WAY CENTRE
5	A-5000-7811	M2 STAR STY 4-WAY D1R L7,5 S10
6	A-5004-7585	SE4 STYLUS EXTENSION
7	A-5004-7586	SE5 STYLUS EXTENSION
8	A-5004-7583	SE2 STYLUS EXTENSION
9	A-5004-7609	SE8 STYLUS EXTENSION
10	A-5004-7592	SA3 STYLUS ADAPTOR
11	A-5003-0470	M2 STYLUS D6R L50 EWL50 d2.5CR
12	A-5000-8663	M2 STY D1R L27.5 EWL20.5 d0.7TC

Position	Part number	Description
13	A-5003-1345	M2 STY D0.5R L20 EWL7 d0.34TC
14	A-5000-3603	M2 STY D2R EWL13.9 d1.4SS
15	A-5000-7800	M2 STY D0,3R L10 EWL1,8 d0,2TC
16	A-5000-7802	M2 STY D1,5R L10 EWL5,4 d0,7SS
17	A-5000-3551	M3 STY D1R L21 EWL4 d0.7SS
18	A-5000-3552	M3 STY D2R L21 EWL11 d1.4SS
19	A-5000-7630	M2 STY D5R L21 d2,5SS
20	A-5003-5061	M3 STY D4iN L21 EWL21 D2.5SS
21	A-5003-0051	M3 STY D1,5R L30 EWL22,5 d1TC
22	A-5003-5724	M3 STY D2SiN L30 EWL22.5 d1.5TC
23	A-5003-0053	M3 STY D2R L40 EWL32,5 d1,5TC
24	A-5003-4787	M2 STAR STY 4xD0.5 S20 EWL 7

A-5004-7235 Stylus cleaning kit

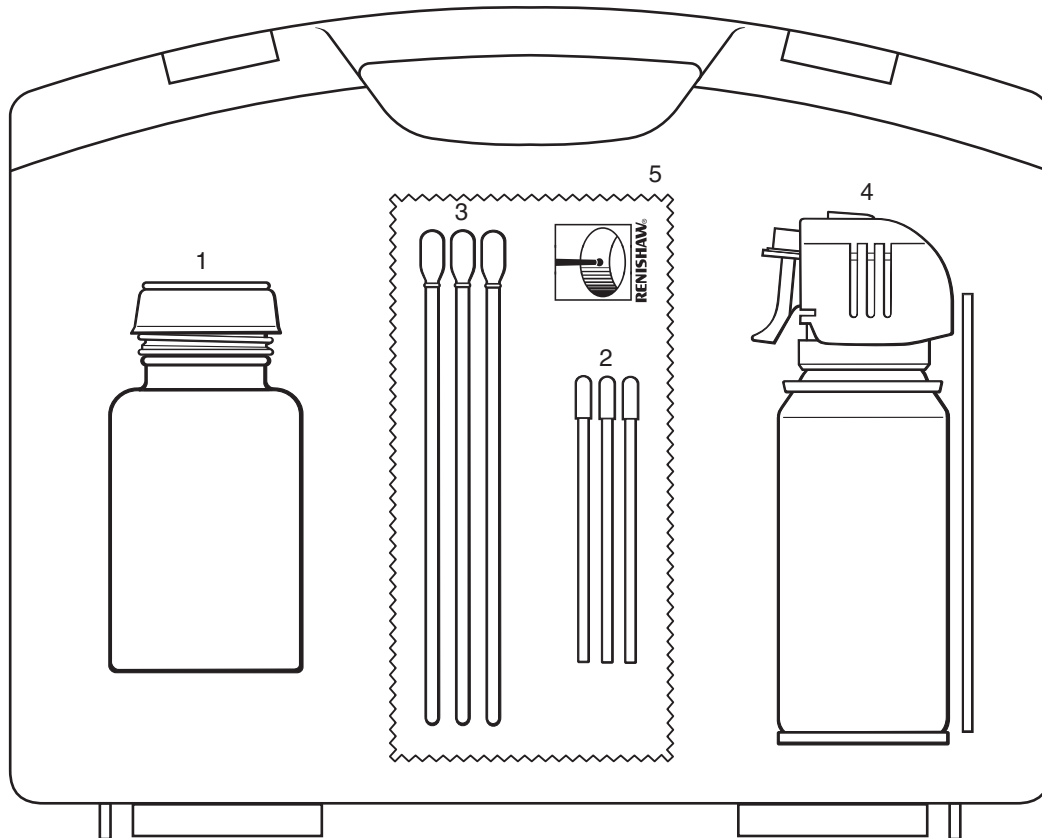

Position	Part number	Description
1	A-5004-7236	EMPTY IPA PUMP POT (BLACK)
2	A-5004-7237	SMALL LINT FREE BUDS (100 OFF)
3	A-5004-7238	LARGE LINT FREE BUDS (100 OFF)
4	A-5004-7239	87 ML AIR DUSTER
5	A-5004-7240	CLEANING CLOTH

Datum balls

Datum spheres are made from hard-wearing tungsten carbide and come supplied with individual UKAS certificates stating ball diameter and roundness. All sphere measurements are performed on equipment traceable to UK (NPL) standards.

Datum sphere kit	Grade 5 (0.13 µm)	Grade 3 (0.08 µm)
Ø12 mm datum ball	A-1034-0028	A-1034-0361
Ø19 mm datum ball	A-1034-0027	A-1034-0360
Ø25 mm datum ball	A-1034-0026	A-1034-0359
Ø¾ in. datum ball	A-1034-0031	A-1034-0363
Ø1 in. datum ball	A-1034-0035	A-1034-0362

Fixing stud – a fixing stud is required with each kit to attach pillar to table surface.

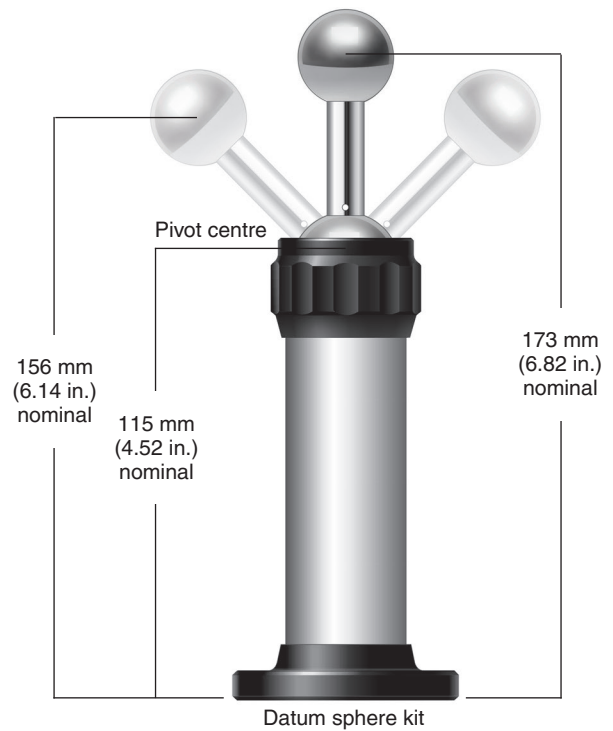

Fixing stud thread size	Part number
M6 × 1	A-1034-0352
M8 × 1.25	A-1034-0351
M10 × 1.5	A-1034-0350
5/16 - 18 × UNC	A-1034-0354
3/8 - 16 × UNC	A-1034-0353



Datum balls continued

Optional extras

Datum ball	Grade 5 (0.13 µm)	Grade 3 (0.08 µm)
Ø12 mm datum ball	A-1034-0005	A-1034-0538
Ø19 mm datum ball	A-1034-0023	A-1034-0595
Ø25 mm datum ball	A-1034-0002	A-1034-0596
Ø¾ in. datum ball	A-1034-0032	A-1034-0358
Ø1 in. datum ball	A-1034-0036	A-1034-0243

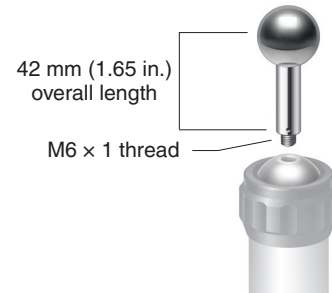

Revo datum ball	Part number
Ø45 mm M10F	A-3060-0310

A certified Ceramic ball is used on the Revo datum sphere



Accessories	Part number
2 way adaptor	A-1034-0356
3 way adaptor	A-1034-0357
Pillar extension 75 mm	A-1034-0355
Magnetic base	A-1034-0385
45° magnetic base	A-1034-0550
Gramme gauge 4 - 30 g	P-GA01-0001

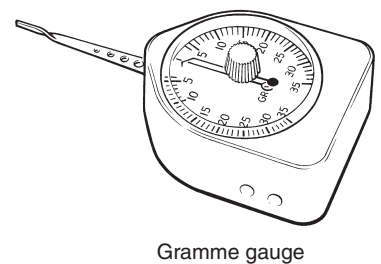
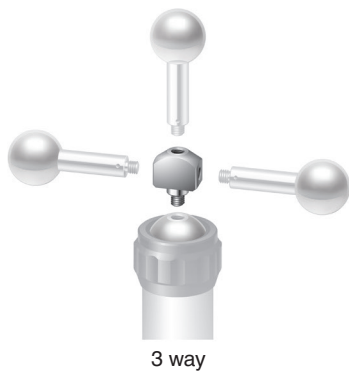
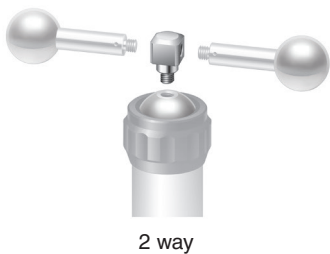

Product listing by part number

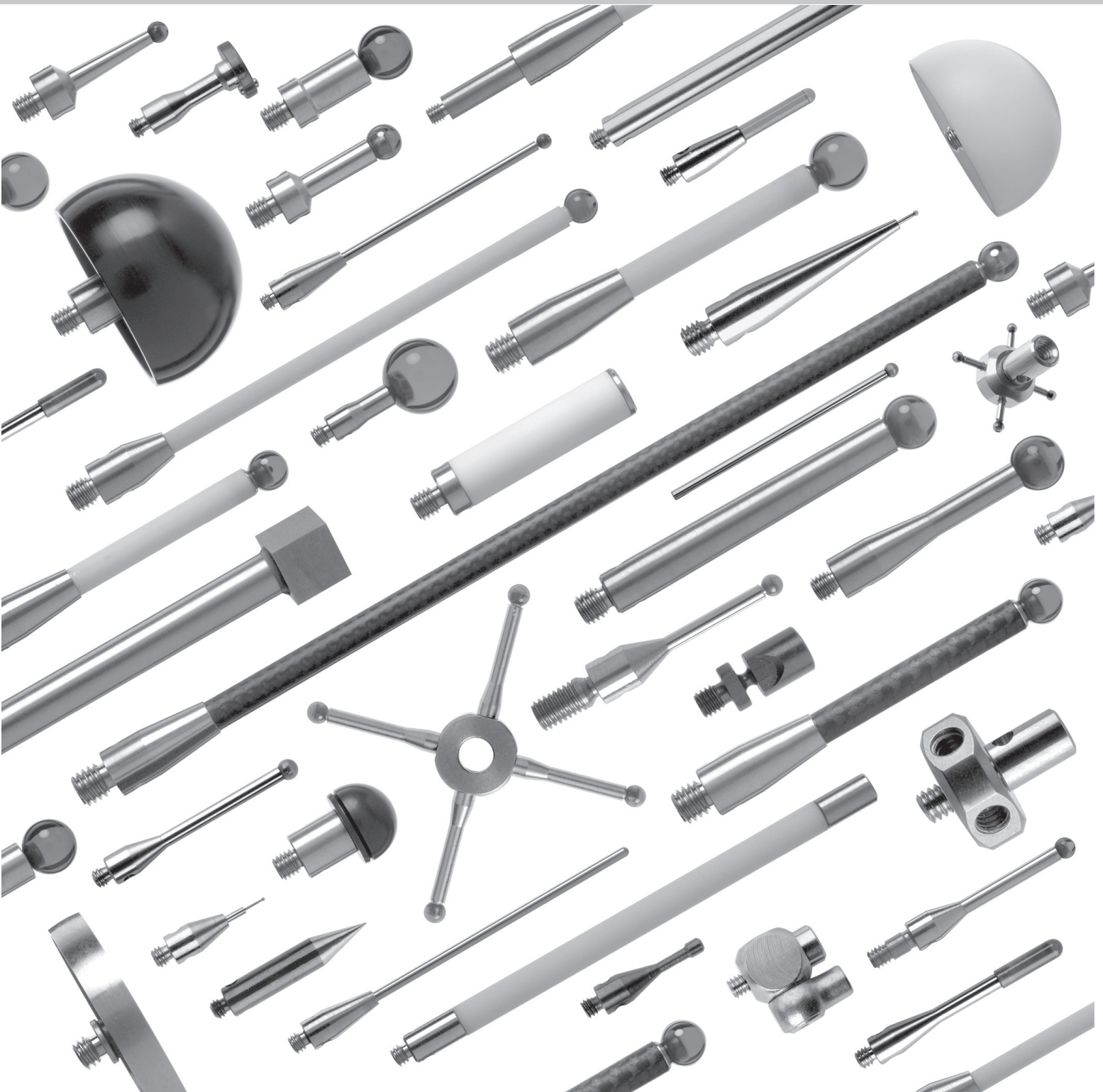

Styli and accessories

Part no.	PS no	Description	Thread	Component	Ball/tip size (mm)	Ball/tip Material	Length (mm)	Stem material	EWL (mm)	Mass (g)	Section no.
A-1034-0002	-	DATUM BALL D25	-	Accessory	25.0	Tungsten carbide	-	-	-	-	8.24
A-1034-0005	-	DATUM BALL D12	-	Accessory	12.0	Tungsten carbide	-	-	-	-	8.24
A-1034-0023	-	DATUM BALL D19	-	Accessory	19.0	Tungsten carbide	-	-	-	-	8.24
A-1034-0026	-	DATUM SPHERE KIT D25	-	Accessory	25.0	Tungsten carbide	-	-	-	-	8.23
A-1034-0027	-	DATUM SPHERE KIT D19	-	Accessory	19.0	Tungsten carbide	-	-	-	-	8.23
A-1034-0028	-	DATUM SPHERE KIT D12	-	Accessory	12.0	Tungsten carbide	-	-	-	-	8.23
A-1034-0031	-	DATUM SPHERE KIT D¾	-	Accessory	¾	Tungsten carbide	-	-	-	-	8.23
A-1034-0032	-	DATUM BALL D¾	-	Accessory	¾	Tungsten carbide	-	-	-	-	8.24
A-1034-0035	-	DATUM SPHERE KIT D1IN	-	Accessory	1 in.	Tungsten carbide	-	-	-	-	8.23
A-1034-0036	-	DATUM BALL D1IN	-	Accessory	1 in.	Tungsten carbide	-	-	-	-	8.24
A-1034-0243	-	D1" DATUM BALL M6 (GRADE 3)	-	Accessory	25.4	Tungsten carbide	-	-	-	-	8.24
A-1034-0350	-	DATUM FIXING STUD M10	-	Accessory	-	-	-	-	-	-	8.23
A-1034-0351	-	DATUM FIXING STUD M8	-	Accessory	-	-	-	-	-	-	8.23
A-1034-0352	-	DATUM FIXING STUD M6	-	Accessory	-	-	-	-	-	-	8.23
A-1034-0353	-	DATUM FIXING STUD 3/8 UNC	-	Accessory	-	-	-	-	-	-	8.23
A-1034-0354	-	DATUM FIXING STUD 5/16 UNC	-	Accessory	-	-	-	-	-	-	8.23
A-1034-0355	-	DATUM EXTENSION L75	-	Accessory	-	-	-	-	-	-	8.24
A-1034-0356	-	DATUM ADAPTER 2WAY	-	Accessory	-	-	-	-	-	-	8.24
A-1034-0357	-	DATUM ADAPTER 3WAY	-	Accessory	-	-	-	-	-	-	8.24
A-1034-0358	-	M6 DAT BALL D19.05TC(0.08) L42	-	Accessory	19.05	Tungsten carbide	-	-	-	-	8.24
A-1034-0359	-	DIA 25 (0.08) DATUM BALL KIT	-	Accessory	25.0	Tungsten carbide	-	-	-	-	8.23
A-1034-0360	-	DIA 19 (0.08) DATUM BALL KIT	-	Accessory	19.0	Tungsten carbide	-	-	-	-	8.23
A-1034-0361	-	DIA 12 (0.08) DATUM BALL KIT	-	Accessory	12.0	Tungsten carbide	-	-	-	-	8.23
A-1034-0362	-	DIA 25.4 (0.08) DATUM BALL KIT	-	Accessory	25.4	Tungsten carbide	-	-	-	-	8.23
A-1034-0363	-	DIA 19.05 (0.08) DATUM BALL KIT	-	Accessory	19.05	Tungsten carbide	-	-	-	-	8.23
A-1034-0385	-	MAG BASE ASSEMBLY	-	Accessory	-	-	-	-	-	-	8.24
A-1034-0538	-	M6 DAT BALL D12TC(0.08) L42	-	Accessory	12.0	Tungsten carbide	-	-	-	-	8.24
A-1034-0550	-	MAG BASE M6 45° MTG BLOCK ASSY	-	Accessory	-	-	-	-	-	-	8.24
A-1034-0595	-	M6 DATUM BALL D19 (0.08) L42	-	Accessory	19.0	Tungsten carbide	-	-	-	-	8.24
A-1034-0596	-	M6 DATUM BALL D25 (0.08) L42	-	Accessory	25.0	Tungsten carbide	-	-	-	-	8.24
A-2008-0382	-	TS27R TDS L23 TIP12.7×8	-	Tool datuming	12.7	Tungsten carbide	23.0	Stainless steel	-	12.1	5.15
A-2008-0384	-	TS27R TDS L22 TIP19×19×8	-	Tool datuming	19.0	Ceramic	22.0	Stainless steel	-	7.1	5.15
A-2008-0448	-	TS27R OTS HORIZONTAL ADAPTER KIT	-	Tool datuming	-	-	-	Stainless steel	-	-	5.14
A-2008-0601	-	STYLUS ASSEMBLY (025)	M4	Tool datuming	-	-	15.4	Tungsten carbide	-	9.1	5.13
A-2008-0602	-	STYLUS ASSEMBLY (032)	M4	Tool datuming	-	-	24.0	Tungsten carbide	-	8.0	5.13
A-2008-0603	-	STYLUS ASSEMBLY (040)	M4	Tool datuming	-	-	32.4	Tungsten carbide	-	8.95	5.13
A-2048-2050	-	M4 × 23.2 LG STYLUS ASSY	M4	Tool datuming	-	-	23.2	Tungsten carbide	-	18.14	5.13
A-2048-2051	-	M4 × 32 LG STYLUS ASSY	M4	Tool datuming	-	-	32.0	Tungsten carbide	-	20.64	5.13
A-2054-6350	SA1	M4-Ø4.5 EXT L10SS	M4	Extension	-	-	10.0	Stainless steel	-	5.0	8.3
A-2116-0140	-	TSA 25 MM STYLUS KIT	M4	Tool datuming	-	-	32.0	Tungsten carbide	-	13.56	5.13
A-2116-0141	-	TSA 32 MM STYLUS KIT	M4	Tool datuming	-	-	42.0	Tungsten carbide	-	16.05	5.13
A-2116-0142	-	TSA 40 MM STYLUS KIT	M4	Tool datuming	-	-	30.3	Tungsten carbide	-	22.6	5.12
A-2197-0157	-	STYLUS KIT FOR 16 MM TOOLING	M4	Tool datuming	-	-	14.2	Tungsten carbide	-	14.86	5.13
A-2197-0158	-	STYLUS KIT FOR 20 MM TOOLING	M4	Tool datuming	-	-	19.5	Tungsten carbide	-	16.0	5.13
A-2197-0159	-	STYLUS KIT FOR 25 MM TOOLING	M4	Tool datuming	-	-	29.5	Tungsten carbide	-	20.0	5.13
A-2197-0160	-	STYLUS KIT FOR 32 MM TOOLING	M4	Tool datuming	-	-	34.5	Tungsten carbide	-	20.7	5.13
A-2197-0161	-	STYLUS KIT FOR 40 MM TOOLING	M4	Tool datuming	-	-	39.5	Tungsten carbide	-	21.8	5.13
A-2197-0162	-	STYLUS KIT FOR 50 MM TOOLING	M4	Tool datuming	-	-	49.5	Tungsten carbide	-	23.5	5.13
A-3060-0310	-	REVO DATUM BALL KIT	-	Accessory	45.0	Ceramic	-	-	-	-	8.24
A-5000-0001	-	M2 KIT COMPREHENSIVE	-	Accessory	-	-	-	-	-	-	8.7
A-5000-0002	-	M2 KIT ENHANCEMENT	-	Accessory	-	-	-	-	-	-	8.5
A-5000-3212	PS1-13	MP4 TDS L53 TIP6×6×6	M4	Tool datuming	6.0	Tungsten carbide	53.0	Stainless steel	-	4.5	5.12
A-5000-3551	PS1-9R	M3 STY D1R L21 EWL4 d0.7SS	M3	Ball stylus	1.0	Ruby	21.0	Stainless steel	4.0	1.0	4.2
A-5000-3552	PS1-10R	M3 STY D2R L21 EWL9.6 d1.4SS	M3	Ball stylus	2.0	Ruby	21.0	Stainless steel	9.6	1.0	4.2
A-5000-3553	PS1-11R	M3 STY D3R L21 EWL14.7 d1.5SS	M3	Ball stylus	3.0	Ruby	21.0	Stainless steel	14.7	1.0	4.2
A-5000-3554	PS1-1R	M3 STY D4R L31 EWL27 d2.5SS	M3	Ball stylus	4.0	Ruby	31.0	Stainless steel	27.0	2.5	4.2
A-5000-3603	PS2R	M2 STY D2R L20 EWL14 d1.4SS	M2	Ball stylus	2.0	Ruby	20.0	Stainless steel	14.0	0.4	3.2
A-5000-3604	PS1R	M2 STY D3R L10 EWL7 d1.5SS	M2	Ball stylus	3.0	Ruby	10.0	Stainless steel	7.0	0.4	3.2
A-5000-3609	-	M2 STC D2R L16.5 EWL12.0 d1.4SS	M2	Star centre	2.0	Ruby	16.5	Stainless steel	12.0	0.44	3.11
A-5000-3611	PS3R	M2 DSC D6R T1.2 L10 BR-Y2	M2	Disc	6.0	Ruby	10.0	Stainless steel	1.2	0.6	3.12

Part no.	PS no	Description	Thread	Component	Ball/tip size (mm)	Ball/tip Material	Length (mm)	Stem material	EWL (mm)	Mass (g)	Section no.
A-5000-3613	PS4R	M2 DSC D18SLVS T2.2 L2.6 BR-Y3	M2	Disc	18.0	Silver steel	2.6	Stainless steel	2.3	2.7	3.12
A-5000-3614	PS21R	M2 HEM D18CE	M2	Hemispherical	18.0	Ceramic	11.0	Stainless steel	-	3.3	3.15
A-5000-3615	PS1-3R	M3 DSC D12.7SLVS T2 L30.8 BR-N	M3	Disc	12.7	Silver steel	30.8	Stainless steel	2.2	4.0	4.8
A-5000-3626	PS7R	M2 STR D2 5BALL L19.5 S30	M2	Star	2.0	Ruby	19.2	Stainless steel	12.0	1.8	3.11
A-5000-3627	SC2	M2 ACC CENTRE 5WAY	M2	Accessory	-	-	7.5	Stainless steel	7.5	0.8	8.2
A-5000-3709	PS3-1C	M4 STY D6R L50 EWL38.5 d4.5CE	M4	Ball stylus	6.0	Ruby	50.0	Ceramic	38.5	4.8	5.3
A-5000-3712	PS3-2C	M4 STY D6R L100 EWL88.5 d4.5CE	M4	Ball stylus	6.0	Ruby	100.0	Ceramic	88.5	6.3	5.4
A-5000-4154	PS12R	M2 STY D4R L10 EWL10 d1.5SS	M2	Ball stylus	4.0	Ruby	10.0	Stainless steel	10.0	0.4	3.2
A-5000-4155	PS13R	M2 STY D5R L10 EWL10 d2.5SS	M2	Ball stylus	5.0	Ruby	10.0	Stainless steel	10.0	0.7	3.2
A-5000-4156	PS14R	M2 STY D6R L10 d2.5SS	M2	Ball stylus	6.0	Ruby	10.0	Stainless steel	10.0	0.9	3.2
A-5000-4158	PS15R	M2 STY D8R L11 EWL11 d2.5SS	M2	Ball stylus	8.0	Ruby	11.0	Stainless steel	11.0	1.5	3.2
A-5000-4160	PS16R	M2 STY D3R L20 EWL17 d1.5SS	M2	Ball stylus	3.0	Ruby	20.0	Stainless steel	17.0	0.5	3.2
A-5000-4161	PS17R	M2 STY D4R L20 EWL20 d1.5SS	M2	Ball stylus	4.0	Ruby	20.0	Stainless steel	20.0	0.6	3.2
A-5000-4187	PS22R	M2 DSC D25SLVS T3 L2.5 BR-N	M2	Disc	25.0	Silver steel	2.5	Stainless steel	3.0	3.8	3.12
A-5000-5302	-	PS2-1R CRANKED STYLUS	M4	Cranked stylus	-	Ruby	32.0	Stainless steel	-	3.8	5.11
A-5000-5307	-	PS2-11R CRANKED STYLUS	M4	Cranked stylus	-	Ruby	21.6	Stainless steel	-	3.85	5.11
A-5000-6350	-	M4 STY D5R L10 EWL5.5 d3SS	M4	Ball stylus	5.0	Ruby	10.0	Stainless steel	5.0	1.9	5.2
A-5000-6351	-	M4 DSC SD30SILV T3 L10 BR-N	M4	Disc	30.0	Silver steel	10.0	Silver steel	3.0	7.9	5.6
A-5000-6352	PS2-23R	M4 STY D5R L30 EWL26 d3SS	M4	Ball stylus	5.0	Ruby	30.0	Stainless steel	26.0	3.0	5.2
A-5000-6403	PS2-41	M4 TDS L32.5 TIP9.3x9.3x3 LP2	M4	Tool datuming	9.3	Tungsten carbide	32.5	Stainless steel	-	11.0	5.12
A-5000-6462	PS3-5C	M4 STC D6R L100 EWL88.5 D4.5CE	M4	Star centre	6.0	Ruby	100.0	Ceramic	88.5	7.5	5.6
A-5000-6620	-	PS2-2R CRANKED STYLUS	M4	Cranked stylus	-	Ruby	27.4	Stainless steel	-	4.7	5.11
A-5000-6701	PS1-14	MP4 TDS L43 TIP6x6x6	M4	Tool datuming	6.0	Tungsten carbide	43.0	Stainless steel	-	4.3	5.12
A-5000-6713	PS2-40	M4 TDS L96.5 TIP10x10x5 MP6-3	M4	Tool datuming	10.0	Tungsten carbide	96.5	Carbon fibre	-	21.9	5.12
A-5000-6731	PS2-22R	M4 STY D5R L20 EWL16 d3SS	M4	Ball stylus	5.0	Ruby	20.0	Stainless steel	15.89	2.4	5.2
A-5000-7098	PS3-4C	M4 STC D6R L50 EWL38.5 D4.5CE	M4	Star centre	6.0	Ruby	50.0	Ceramic	38.5	6.0	5.6
A-5000-7521	PS3-1R	M4 STY D5R L50 EWL33.5 d4.5SS	M4	Ball stylus	5.0	Ruby	50.0	Stainless steel	33.5	5.8	5.3
A-5000-7522	PS3-2R	M4 STY D5R L100 EWL83.2 d4.5SS	M4	Ball stylus	5.0	Ruby	100.0	Stainless steel	83.2	11.3	5.4
A-5000-7523	-	M4 STY D5R L150 EWL133 d4.45SS	M4	Ball stylus	5.0	Ruby	150.0	Stainless steel	133.0	17.4	5.4
A-5000-7534	SK2	M2 ACC KNUCKLE OFFSET	M2	Accessory	-	-	8.0	Stainless steel	8.0	1.6	8.2
A-5000-7545	PS2-3R	M4 STY D1R L19.5 EWL4.5 d0.7SS	M4	Ball stylus	1.0	Ruby	19.5	Stainless steel	4.5	2.5	5.2
A-5000-7547	PS2-4R	M4 STY D2R L19 EWL9.2 d1.4SS	M4	Ball stylus	2.0	Ruby	19.0	Stainless steel	9.2	2.3	5.2
A-5000-7549	-	M4 STY D3R L18.5 EWL13 d2SS	M4	Ball stylus	3.0	Ruby	18.5	Stainless steel	13.0	2.0	5.2
A-5000-7551	-	M4 STY D4R L18 EWL13.7 d3SS	M4	Ball stylus	4.0	Ruby	18.0	Stainless steel	13.7	2.1	5.2
A-5000-7553	PS2-7R	M4 STY D5R L17.5 EWL13.6 d3.5SS	M4	Ball stylus	5.0	Ruby	17.5	Stainless steel	13.6	2.3	5.2
A-5000-7555	PS2-8R	M4 STY D6R L17 EWL13.3 d4.5SS	M4	Ball stylus	6.0	Ruby	17.0	Stainless steel	13.3	3.0	5.2
A-5000-7557	PS2-9R	M4 STY D8R L16 EWL16 d6SS	M4	Ball stylus	8.0	Ruby	16.0	Stainless steel	16.0	3.9	5.2
A-5000-7580	-	LP2 CRANK STYLUS	M4	Cranked stylus	-	Ruby	38.8	Stainless steel	-	2.5	5.11
A-5000-7596	PS2-12R	M4 DSC D30SLVS T2.2 L8.9 BR-Y3	M4	Disc	30.0	Silver steel	8.9	Stainless steel	2.2	8.01	5.6
A-5000-7597	PS2-13R	M4 DSC D35SLVS T2.2 L8.9 BR-Y3	M4	Disc	35.0	Silver steel	8.9	Stainless steel	2.2	9.57	5.6
A-5000-7598	PS2-14R	M4 DSC D50SLVS T3 L8.9 BR-Y4	M4	Disc	50.0	Silver steel	8.9	Stainless steel	3.0	13.55	5.6
A-5000-7606	PS1-12R	M3 STY D4R L21 EWL17.2 d2.5SS	M3	Ball stylus	4.0	Ruby	21.0	Stainless steel	17.2	1.3	4.2
A-5000-7610	SC4	M3 ACC CENTRE 5WAY	M3	Accessory	-	-	13.0	Stainless steel	13.0	3.6	8.2
A-5000-7612	PS1-5R	M3 DSC D35SLVS T5 L3.5 BR-N	M3	Disc	35.0	Silver steel	3.5	Stainless steel	5.0	10.0	4.8
A-5000-7616	SK3	M3 ACC KNUCKLE OFFSET	M3	Accessory	-	-	12.0	Stainless steel	12.0	3.7	8.2
A-5000-7629	-	M2 STR D2 5BALL L19.2 S18	M2	Star	2.0	Ruby	19.2	Stainless steel	12.0	1.3	3.11
A-5000-7630	PS1-13R	M3 STY D5R L21 EWL21 d2.5SS	M3	Ball stylus	5.0	Ruby	21.0	Stainless steel	21.0	1.5	4.2
A-5000-7632	PS1-8R	M3 STY D0.5R L21 EWL2 d0.4TC	M3	Ball stylus	0.5	Ruby	21.0	Tungsten carbide	2.0	1.0	4.3
A-5000-7648	PS1-14R	M3 STY D5R L31 EWL31 d3.5SS	M3	Ball stylus	5.0	Ruby	31.0	Stainless steel	31.0	3.0	4.2
A-5000-7669	PS1-15R	M3 DSC D63.5CS T6 L4 BR-N	M3	Disc	63.5	Carbon steel	4.0	Stainless steel	6.0	45.0	4.8
A-5000-7670	-	M4 STY D5TC L50 EWL35	M4	Ball stylus	5.0	Tungsten carbide	50.0	Stainless steel	35.0	6.2	5.17
A-5000-7671	-	M4 STY D5TC L100 EWL85	M4	Ball stylus	5.0	Tungsten carbide	100.0	Stainless steel	85.0	11.9	5.17
A-5000-7672	-	M4 STY D5TC L150 EWL135	M4	Ball stylus	5.0	Tungsten carbide	150.0	Stainless steel	135.0	18.2	5.17
A-5000-7727	SE-30	M4 EXT L100 d7.4CE	M4	Extension	-	-	100.0	Ceramic	-	10.6	5.16
A-5000-7751	SE22	M4-M3 EXT L50CE	M4	Extension	-	-	50.0	Ceramic	-	4.4	8.3
A-5000-7752	SE23	M4-M3 EXT L75CE	M4	Extension	-	-	75.0	Ceramic	-	5.2	8.3
A-5000-7753	SE24	M4-M3 EXT L100CE	M4	Extension	-	-	100.0	Ceramic	-	6.3	8.3
A-5000-7754	SE-19	M4 EXT L30 d7.4CE	M4	Extension	-	-	30.0	Ceramic	-	5.1	5.16
A-5000-7755	SE-20	M4 EXT L50 d7.4CE	M4	Extension	-	-	50.0	Ceramic	-	6.7	5.16
A-5000-7792	SC5	M4 ACC CENTRE 5WAY	M4	Accessory	-	-	18.0	Stainless steel	-	12.1	8.2

Styli and accessories

Part no.	PS no	Description	Thread	Component	Ball/tip size (mm)	Ball/tip Material	Length (mm)	Stem material	EWL (mm)	Mass (g)	Section no.
A-5000-7795	PS3-6C	M4 STY D8R L50 EWL50 d4.5CE	M4	Ball stylus	8.0	Ruby	50.0	Ceramic	50.0	5.4	5.3
A-5000-7796	PS3-7C	M4 STY D8R L100 EWL100 d4.5CE	M4	Ball stylus	8.0	Ruby	100.0	Ceramic	100.0	7.5	5.4
A-5000-7800	PS29R	M2 STY D0.3R L10 EWL2 d0.2TC	M2	Ball stylus	0.3	Ruby	10.0	Tungsten carbide	2.0	0.3	3.2
A-5000-7801	PS31R	M2 STY D0.7R L10 EWL4 d0.5TC	M2	Ball stylus	0.7	Ruby	10.0	Tungsten carbide	4.0	0.3	3.2
A-5000-7802	PS24R	M2 STY D1.5R L10 EWL4.5 d0.7SS	M2	Ball stylus	1.5	Ruby	10.0	Stainless steel	4.5	0.3	3.2
A-5000-7803	PS26R	M2 STY D2.5R L10 EWL6.5 d1SS	M2	Ball stylus	2.5	Ruby	10.0	Stainless steel	6.5	0.3	3.2
A-5000-7804	PS27R	M2 STY D2.5R L20 EWL16.4 d1.4SS	M2	Ball stylus	2.5	Ruby	20.0	Stainless steel	16.4	0.4	3.2
A-5000-7805	PS10R	M2 STY D0.5R L10 EWL3 d0.4TC	M2	Ball stylus	0.5	Ruby	10.0	Tungsten carbide	3.0	0.3	3.2
A-5000-7806	PS9R	M2 STY D1R L10 EWL4.5 d0.7SS	M2	Ball stylus	1.0	Ruby	10.0	Stainless steel	4.5	0.3	3.2
A-5000-7807	PS8R	M2 STY D2R L10 EWL6 d1SS	M2	Ball stylus	2.0	Ruby	10.0	Stainless steel	6.0	0.3	3.2
A-5000-7808	PS23R	M2 STY D1R L20 EWL7 d0.7TC	M2	Ball stylus	1.0	Ruby	20.0	Tungsten carbide	7.0	0.50	3.3
A-5000-7809	PS33R	M2 DSC D18SLVS T1.6 L8.6 BR-Y2.5	M2	Disc	18.0	Silver steel	8.6	Stainless steel	1.5	3.0	3.12
A-5000-7810	PS34R	M2 DSC D25SLVS T1.6 L8.6 BR-Y2.5	M2	Disc	25.0	Silver steel	8.6	Stainless steel	1.5	4.0	3.12
A-5000-7811	PS28R	M2 STR D1R 4BALL L7.5T S10	M2	Star	1.0	Ruby	7.5	Stainless steel	-	0.5	3.11
A-5000-7812	PS35R	M2 SPH D2R L20 EWL7.2 SS	M2	Spherically ended cylinder	2.0	Ruby	20.0	Stainless steel	7.2	0.5	3.13
A-5000-7813	PS36R	M2 PNT D1.4TC 30deg L10	M2	Pointer	1.4	Tungsten carbide	10.0	Stainless steel	-	0.7	3.15
A-5000-7814	PS1-16R	M3 HEM D30CE	M3	Hemispherical	30.0	Ceramic	17.0	Stainless steel	-	13.0	4.8
A-5000-7829	-	M4 STYLUS KIT (TP7M)	M4	Accessory	-	-	-	-	-	-	8.11
A-5000-8156	-	M4 STY D6R L150 EWL135 d4.5CE	M4	Ball stylus	6.0	Ruby	150.0	Ceramic	135.0	7.9	5.4
A-5000-8395	SC6	M2 ACC CENTRE 4WAY	M2	Accessory	-	-	7.5	Stainless steel	-	1.1	8.2
A-5000-8663	PS51R	M2 STY D1R L27.5 EWL20.5 d0.7TC	M2	Ball stylus	1.0	Ruby	27.5	Tungsten carbide	20.5	0.40	3.3
A-5000-8876	PS44R	M2 SPH D1R L15 EWL8	M2	Spherically ended cylinder	1.0	Ruby	15.0	Stainless steel	8.0	0.3	3.13
A-5000-8877	PS45R	M2 SPH D1.5R L15 EWL8	M2	Spherically ended cylinder	1.5	Ruby	15.0	Stainless steel	8.0	0.3	3.13
A-5000-9685	-	M4 STY D5TC L54 EWL50	M4	Ball stylus	5.0	Tungsten carbide	54.0	Stainless steel	50.0	6.9	5.17
A-5000-9697	-	M4 STY D3TC L55 EWL25	M4	Ball stylus	3.0	Tungsten carbide	55.0	Stainless steel	25.0	3.8	5.17
A-5000-9761	-	M4 STY D5R L100 EWL83.5 d3.8CE	M4	Ball stylus	5.0	Ruby	100.0	Ceramic	83.5	6.3	5.4
A-5000-9902	-	M2 ACC KNUCKLE ROTARY	M2	Accessory	-	-	16.5	Stainless steel	-	1.3	8.2
A-5003-0033	PS48R	M2 STY D1R L20 EWL12.5 d0.8TC	M2	Ball stylus	1.0	Ruby	20.0	Tungsten carbide	12.5	0.41	3.3
A-5003-0034	PS49R	M2 STY D1.5R L20 EWL12.5 d1TC	M2	Ball stylus	1.5	Ruby	20.0	Tungsten carbide	12.5	0.50	3.3
A-5003-0035	PS52R	M2 STY D1.5R L30 EWL22.5 d1TC	M2	Ball stylus	1.5	Ruby	30.0	Tungsten carbide	22.5	0.58	3.3
A-5003-0036	PS53R	M2 STY D2R L30 EWL22.5 d1.5TC	M2	Ball stylus	2.0	Ruby	30.0	Tungsten carbide	22.5	0.99	3.3
A-5003-0037	PS58R	M2 STY D2R L40 EWL32.5 d1.5TC	M2	Ball stylus	2.0	Ruby	40.0	Tungsten carbide	32.5	1.29	3.5
A-5003-0038	PS54R	M2 STY D2.5R L30 EWL22.5 d2TC	M2	Ball stylus	2.5	Ruby	30.0	Tungsten carbide	22.5	1.48	3.3
A-5003-0039	PS59R	M2 STY D2.5R L40 EWL32.5 d2TC	M2	Ball stylus	2.5	Ruby	40.0	Tungsten carbide	32.5	1.95	3.5
A-5003-0040	PS55R	M2 STY D3R L30 EWL27 d2TC	M2	Ball stylus	3.0	Ruby	30.0	Tungsten carbide	27.0	1.49	3.3
A-5003-0041	PS60R	M2 STY D3R L40 EWL37 d2TC	M2	Ball stylus	3.0	Ruby	40.0	Tungsten carbide	37.0	1.97	3.5
A-5003-0042	PS63R	M2 STY D3R L50 EWL47 d2TC	M2	Ball stylus	3.0	Ruby	50.0	Tungsten carbide	47.0	2.44	3.5
A-5003-0043	PS56R	M2 STY D4R L30 EWL30 d2TC	M2	Ball stylus	4.0	Ruby	30.0	Tungsten carbide	30.0	1.57	3.3
A-5003-0044	PS61R	M2 STY D4R L40 EWL40 d2TC	M2	Ball stylus	4.0	Ruby	40.0	Tungsten carbide	40.0	2.04	3.5
A-5003-0045	PS64R	M2 STY D4R L50 EWL50 d2TC	M2	Ball stylus	4.0	Ruby	50.0	Tungsten carbide	50.0	2.52	3.5
A-5003-0046	PS50R	M2 STY D5R L20 EWL20 d2.5TC	M2	Ball stylus	5.0	Ruby	20.0	Tungsten carbide	20.0	1.98	3.3
A-5003-0047	PS57R	M2 STY D5R L30 EWL30 d2.5TC	M2	Ball stylus	5.0	Ruby	30.0	Tungsten carbide	30.0	2.57	3.3
A-5003-0048	PS26R	M2 STY D5R L40 EWL40 d2.5TC	M2	Ball stylus	5.0	Ruby	40.0	Tungsten carbide	40.0	3.17	3.5
A-5003-0049	PS65R	M2 STY D5R L50 EWL50 d2.5TC	M2	Ball stylus	5.0	Ruby	50.0	Tungsten carbide	50.0	3.75	3.5
A-5003-0050	PS1-17R	M3 STY D1.5R L20 EWL12.5 d1TC	M3	Ball stylus	1.5	Ruby	20.0	Tungsten carbide	12.5	0.8	4.3
A-5003-0051	PS1-19R	M3 STY D1.5R L30 EWL22.5 d1TC	M3	Ball stylus	1.5	Ruby	30.0	Tungsten carbide	22.5	0.93	4.3
A-5003-0052	PS1-20R	M3 STY D2R L30 EWL22.8 d1.5TC	M3	Ball stylus	2.0	Ruby	30.0	Tungsten carbide	22.8	1.32	4.3
A-5003-0053	PS1-23R	M3 STY D2R L40 EWL32.5 d1.5TC	M3	Ball stylus	2.0	Ruby	40.0	Tungsten carbide	32.5	1.58	4.4
A-5003-0054	PS1-18R	M3 STY D2.5R L20.2 EWL12.5 d2TC	M3	Ball stylus	2.5	Ruby	20.2	Tungsten carbide	12.5	1.3	4.3
A-5003-0055	PS1-21R	M3 STY D2.5R L30 EWL22.5 d2TC	M3	Ball stylus	2.5	Ruby	30.0	Tungsten carbide	22.5	1.81	4.3
A-5003-0056	PS1-24R	M3 STY D2.5R L40 EWL32.5 d2TC	M3	Ball stylus	2.5	Ruby	40.0	Tungsten carbide	32.5	2.28	4.4
A-5003-0057	PS1-22R	M3 STY D3R L30 EWL24 d2TC	M3	Ball stylus	3.0	Ruby	30.0	Tungsten carbide	24.0	1.83	4.3
A-5003-0058	PS1-25R	M3 STY D3R L40 EWL33.7 d2TC	M3	Ball stylus	3.0	Ruby	40.0	Tungsten carbide	33.7	2.30	4.4
A-5003-0059	PS1-28R	M3 STY D3R L50 EWL43.7 d2TC	M3	Ball stylus	3.0	Ruby	50.0	Tungsten carbide	43.7	2.78	4.4
A-5003-0060	PS1-26R	M3 STY D4R L40 EWL36 d2TC	M2	Ball stylus	4.0	Ruby	40.0	Tungsten carbide	36.0	2.38	4.4
A-5003-0061	PS1-29R	M3 STY D4R L50 EWL46 d2TC	M3	Ball stylus	4.0	Ruby	50.0	Tungsten carbide	46.0	2.85	4.4
A-5003-0062	PS1-27R	M3 STY D5R L40 EWL40 d2.5TC	M3	Ball stylus	5.0	Ruby	40.0	Tungsten carbide	40.0	3.50	4.4
A-5003-0063	PS1-30R	M3 STY D5R L50 EWL50 d2.5TC	M3	Ball stylus	5.0	Ruby	50.0	Tungsten carbide	50.0	4.10	4.4
A-5003-0064	PS66R	M2 STY D3R L50 EWL47 d2CE	M2	Ball stylus	3.0	Ruby	50.0	Ceramic	47.0	0.83	3.6
A-5003-0065	PS67R	M2 STY D4R L50 EWL50 d2CE	M2	Ball stylus	4.0	Ruby	50.0	Ceramic	50.0	0.91	3.6

Part no.	PS no	Description	Thread	Component	Ball/tip size (mm)	Ball/tip Material	Length (mm)	Stem material	EWL (mm)	Mass (g)	Section no.
A-5003-0066	PS68R	M2 STY D5R L50 EWL50 d2.5CE	M2	Ball stylus	5.0	Ruby	50.0	Ceramic	50.0	1.31	3.6
A-5003-0067	PS1-31R	M3 STY D3R L50 EWL43.7 d2CE	M3	Ball stylus	3.0	Ruby	50.0	Ceramic	43.7	1.17	4.4
A-5003-0068	PS1-32R	M3 STY D4R L50 EWL46 d2CE	M3	Ball stylus	4.0	Ruby	50.0	Ceramic	46.0	1.24	4.4
A-5003-0069	PS1-33R	M3 STY D5R L50 EWL50 d2.5CE	M3	Ball stylus	5.0	Ruby	50.0	Ceramic	50.0	1.33	4.4
A-5003-0070	SE26	M2 EXT L30 d3CE	M2	Extension	-	-	30.0	Ceramic	-	0.97	3.14
A-5003-0071	SE27	M2 EXT L40 d3CE	M2	Extension	-	-	40.0	Ceramic	-	1.22	3.14
A-5003-0072	SE28	M2 EXT L50 d3CE	M2	Extension	-	-	50.0	Ceramic	-	1.51	3.14
A-5003-0073	PS69R	M2 SPH D4R L22 EWL10 SS	M2	Spherically ended cylinder	4.0	Ruby	22.0	Stainless steel	10.0	0.9	3.13
A-5003-0074	PS70R	M2 SPH D2TC L40 EWL32	M2	Spherically ended cylinder	2.0	Tungsten carbide	40.0	Stainless steel	32.0	2.0	3.14
A-5003-0075	SE29	M3 EXT L50 d4CE	M3	Extension	-	-	50.0	Ceramic	-	2.95	4.7
A-5003-0076	PS1-34R	M3 STR D2 5BALL L21.5 S30	M3	Star	2.0	Ruby	21.5	Stainless steel	11.0	2.38	4.8
A-5003-0077	PS1-35R	M3 STR D2 5BALL L31.5 S50	M3	Star	2.0	Ruby	31.5	Stainless steel	11.0	5.25	4.8
A-5003-0233	-	M4 STY D4R L50 EWL33.5 d3.8CE	M4	Ball stylus	4.0	Ruby	50.0	Ceramic	33.5	3.9	5.3
A-5003-0235	-	M4 STY D5R L50 EWL33.5 d3.8CE	M4	Ball stylus	5.0	Ruby	50.0	Ceramic	33.5	5.0	5.3
A-5003-0236	-	M4 STY D5R L75 EWL58.5 d3.8CE	M4	Ball stylus	5.0	Ruby	75.0	Ceramic	58.5	5.63	5.3
A-5003-0470	-	M2 STY D6R L50 EWL50 d2.5CE	M2	Ball stylus	6.0	Ruby	50.0	Ceramic	50.0	1.49	3.6
A-5003-0577	-	M2 STY D0.7R L20 EWL12 d0.5TC	M2	Ball stylus	0.7	Ruby	20.0	Tungsten carbide	12.0	0.32	3.3
A-5003-0587	-	M4 EXT L200 d7.4CE	M4	Extension	-	-	200.0	Ceramic	-	26.7	5.16
A-5003-0661	-	M4 STY BREAK STEM L15 d2.5	M4	Crash protection device	-	-	15.2	Silver steel	-	4.6	5.10
A-5003-0856	-	M5-M4 EXT L9SS	M5	Extension	-	-	9.0	Stainless steel	-	4.6	8.3
A-5003-0938	-	M2 STY D3R L20 EWL17 d1.5TC	M2	Ball stylus	3.0	Ruby	20.0	Tungsten carbide	17.0	0.77	3.3
A-5003-1029	-	M2 STY D4R L22 EWL22 d2TC	M2	Ball stylus	4.0	Ruby	22.0	Tungsten carbide	22.0	1.24	3.3
A-5003-1075	-	M4 STY D6R L200 EWL188.5 d4.5CF	M4	Ball stylus	6.0	Ruby	200.0	Carbon fibre	188.5	8.7	5.5
A-5003-1208	-	M2 SPH D0.3TC L10.2 EWL2.7	M2	Spherically ended cylinder	0.3	Tungsten carbide	10.2	Stainless steel	2.7	0.3	3.14
A-5003-1210	-	M2 SPH D0.5TC L15.3 EWL7.8	M2	Spherically ended cylinder	0.5	Tungsten carbide	15.3	Stainless steel	7.8	0.3	3.14
A-5003-1218	-	M2 SPH D1TC L35.5 EWL28	M2	Spherically ended cylinder	1.0	Tungsten carbide	35.5	Stainless steel	28.0	0.7	3.14
A-5003-1219	-	M2 SPH D1.5TC L15.8 EWL8.3	M2	Spherically ended cylinder	1.5	Tungsten carbide	15.8	Stainless steel	8.3	0.6	3.14
A-5003-1228	-	M2 SPH D2TC L16 EWL8.5	M2	Spherically ended cylinder	2.0	Tungsten carbide	16.0	Stainless steel	8.5	0.8	3.14
A-5003-1255	-	M4 STY D6R L150 EWL138.5 d4.5CF	M4	Ball stylus	6.0	Ruby	150.0	Carbon fibre	138.5	7.5	5.5
A-5003-1258	-	M2 SPH D3TC L22.5 EWL22.5	M2	Spherically ended cylinder	3.0	Tungsten carbide	22.5	Stainless steel	22.5	2.0	3.14
A-5003-1325	-	M2 STY D1R L10 EWL4 d0.7TC	M2	Ball stylus	1.0	Ruby	10.0	Tungsten carbide	4.0	0.3	3.2
A-5003-1345	-	M2 STY D0.5R L20 EWL7 d0.3TC	M2	Ball stylus	0.5	Ruby	20.0	Tungsten carbide	7.0	0.48	3.3
A-5003-1358	-	M4 STY D6R L100 EWL88.5 d4.5CF	M4	Ball stylus	6.0	Ruby	100.0	Carbon fibre	88.5	6.2	5.5
A-5003-1370	-	M2 STY D4R L30 EWL30 d2CE	M2	Ball stylus	4.0	Ruby	30.0	Ceramic	30.0	0.68	3.4
A-5003-1436	-	M4 STY D6R L50 EWL38.5 d4.5CF	M4	Ball stylus	6.0	Ruby	50.0	Carbon fibre	38.5	4.1	5.5
A-5003-1730	PS2R	M2 STY D2SN L20 EWL14 d1.4SS	M2	Ball stylus	2.0	Silicon nitride	20.0	Stainless steel	14.0	0.4	3.2
A-5003-1896	-	M2 STY D2.5R L20 EWL15.5 d1TC	M2	Ball stylus	2.5	Ruby	20.0	Tungsten carbide	15.5	0.5	3.3
A-5003-2020	PS10R	M2 STY D0.5SN L10 EWL3 d0.4TC	M2	Ball stylus	0.5	Silicon nitride	10.0	Tungsten carbide	3.0	0.3	3.2
A-5003-2043	-	M3 STY D2Z L40 EWL32.5 d1.5TC	M3	Ball stylus	2.0	Zirconia	40.0	Tungsten carbide	32.5	1.58	4.4
A-5003-2138	PS1R	M2 STY D3SN L10 EWL7 d1.5SS	M2	Ball stylus	3.0	Silicon nitride	10.0	Stainless steel	7.0	0.4	3.2
A-5003-2186	-	M2 STY D5Z L10 EWL10 d2.5SS	M2	Ball stylus	5.0	Zirconia	10.0	Stainless steel	10.0	0.7	3.2
A-5003-2280	-	M2 EXT L40 d3CF	M2	Extension	-	-	40.0	Carbon fibre	-	0.9	3.15
A-5003-2281	-	M2 EXT L50 d3CF	M2	Extension	-	-	50.0	Carbon fibre	-	1.0	3.15
A-5003-2282	-	M2 EXT L70 d3CF	M2	Extension	-	-	70.0	Carbon fibre	-	1.3	3.15
A-5003-2283	-	M2 EXT L90 d3CF	M2	Extension	-	-	90.0	Carbon fibre	-	1.5	3.15
A-5003-2285	-	M2 STY D4R L50 EWL50 d3CF	M2	Ball stylus	4.0	Ruby	50.0	Carbon fibre	50.0	1.0	3.6
A-5003-2286	-	M2 STY D5R L50 EWL50 d3CF	M2	Ball stylus	5.0	Ruby	50.0	Carbon fibre	50.0	1.1	3.6
A-5003-2287	-	M2 STY D6R L50 EWL50 d3CF	M2	Ball stylus	6.0	Ruby	50.0	Carbon fibre	50.0	1.2	3.6
A-5003-2289	-	M2 STY D4R L100 EWL100 d3CF	M2	Ball stylus	4.0	Ruby	100.0	Carbon fibre	100.0	1.50	3.7
A-5003-2290	-	M2 STY D5R L100 EWL100 d3CF	M2	Ball stylus	5.0	Ruby	100.0	Carbon fibre	100.0	1.59	3.7
A-5003-2291	-	M2 STY D6R L100 EWL100 d3CF	M2	Ball stylus	6.0	Ruby	100.0	Carbon fibre	100.0	1.78	3.7
A-5003-2300	-	M2 STYLUS TOOL CF RANGE	-	Accessory	-	-	-	-	-	-	8.4
A-5003-2310	-	M2 KIT HIGH PERFORMANCE	-	Accessory	-	-	-	-	-	-	8.6
A-5003-2764	-	M4 STY D6R L75 EWL63.5 d4.4CE	M4	Ball stylus	6.0	Ruby	75.0	Ceramic	63.5	5.64	5.3
A-5003-2932	-	M4 STY D2R L20 EWL10 d1.5TC	M4	Ball stylus	2.0	Ruby	20.0	Tungsten carbide	10.0	3.01	5.2
A-5003-3461	-	M4 STY D8R L300 EWL300 d4.5CF	M4	Ball stylus	8.0	Ruby	300.0	Carbon fibre	300.0	10.4	5.4
A-5003-3676	-	M3 D2 L20 STYLUS T/C STEM	M3	Ball stylus	2.0	Ruby	20.0	Tungsten carbide	12.5	1.1	4.3
A-5003-3680	-	M4 STY D3R L50 EWL38.5 d2TC	M4	Ball stylus	3.0	Ruby	50.0	Tungsten carbide	38.5	4.94	5.3
A-5003-3822	-	M2 STY D2R L20 EWL14 d1TC	M2	Ball stylus	2.0	Ruby	20.0	Tungsten carbide	14.0	0.48	3.3
A-5003-3877	-	M2 STY D3R L40 EWL37.5 D2CF	M2	Ball stylus	3.0	Ruby	40.0	Carbon fibre	37.5	0.75	3.10

Styli and accessories

Part no.	PS no	Description	Thread	Component	Ball/tip size (mm)	Ball/tip Material	Length (mm)	Stem material	EWL (mm)	Mass (g)	Section no.
A-5003-4011	-	M2 STR D0.5 4BALL L7.5 S10	M2	Star	0.5	Ruby	7.5	Stainless steel	-	0.7	3.11
A-5003-4177	-	M2 STY D3R L30 EWL27 d2CE	M2	Ball stylus	3.0	Ruby	30.0	Ceramic	27.0	0.44	3.4
A-5003-4241	-	M2 STY D4R L30 EWL30 d2CF	M2	Ball stylus	4.0	Ruby	30.0	Carbon fibre	30.0	0.57	3.4
A-5003-4686	-	M3 ACC KNUCKLE ROTARY	M3	Accessory	-	-	17.0	Stainless steel	-	1.5	8.2
A-5003-4689	-	M4 ACC KNUCKLE ROTARY	M4	Accessory	-	-	33.0	Stainless steel	-	9.8	8.2
A-5003-4697	-	M2 ACC KNUCKLE	M2	Accessory	-	-	13.5	Stainless steel	-	1.1	8.2
A-5003-4779	-	M2 STY D5R L30 EWL30 d2.5CE	M2	Ball stylus	5.0	Ruby	30.0	Ceramic	30.0	0.93	3.4
A-5003-4780	-	M2 STY D6R L30 EWL30 d2.5CE	M2	Ball stylus	6.0	Ruby	30.0	Ceramic	30.0	1.11	3.4
A-5003-4781	-	M2 STY D5R L30 EWL30 d3CF	M2	Ball stylus	5.0	Ruby	30.0	Carbon fibre	30.0	0.79	3.4
A-5003-4782	-	M2 STY D6R L30 EWL30 d3CF	M2	Ball stylus	6.0	Ruby	30.0	Carbon fibre	30.0	0.96	3.4
A-5003-4784	-	M2 STY D4R L75 EWL75 d2CF	M2	Ball stylus	4.0	Ruby	75.0	Carbon fibre	75.0	0.75	3.7
A-5003-4785	-	M2 STY D5R L75 EWL75 d3CF	M2	Ball stylus	5.0	Ruby	75.0	Carbon fibre	75.0	1.35	3.7
A-5003-4786	-	M2 STY D6R L75 EWL75 d3CF	M2	Ball stylus	6.0	Ruby	75.0	Carbon fibre	75.0	1.45	3.7
A-5003-4787	-	M2 STR D0.5 4BALL L7.5 S20	M2	Star	0.5	Ruby	7.5	Stainless steel	-	0.7	3.11
A-5003-4788	-	M2 STR D1 4BALL L7.5 S20	M2	Star	1.0	Ruby	7.5	Stainless steel	-	0.9	3.11
A-5003-4789	-	M2 STC D1R L8.5 EWL3.5 d0.7TC	M2	Star centre	1.0	Ruby	8.5	Tungsten carbide	3.5	0.31	3.11
A-5003-4790	-	M2 STC D0.5R L18.5 EWL7 d0.4TC	M2	Star centre	0.5	Ruby	18.5	Tungsten carbide	7.0	0.43	3.11
A-5003-4791	-	M2 STC D1R L18.5 EWL11 d0.7TC	M2	Star centre	1.0	Ruby	18.5	Tungsten carbide	4.0	0.45	3.11
A-5003-4792	-	M4 STY D1R L20 EWL10 d0.7TC	M4	Ball stylus	1.0	Ruby	20.0	Tungsten carbide	10.0	2.39	5.2
A-5003-4793	-	M4 STY D3R L20 EWL8.5 d1.5TC	M4	Ball stylus	3.0	Ruby	20.0	Tungsten carbide	8.5	3.53	5.2
A-5003-4794	-	M4 STY D4R L20 EWL8.5 d1.5TC	M4	Ball stylus	4.0	Ruby	20.0	Tungsten carbide	8.5	3.53	5.2
A-5003-4795	-	M4 STY D5R L20 EWL7.9 d2.5TC	M4	Ball stylus	5.0	Ruby	20.0	Tungsten carbide	7.9	4.52	5.2
A-5003-4796	-	M4 STY D6R L20 EWL10.7 d2.5TC	M4	Ball stylus	6.0	Ruby	20.0	Tungsten carbide	10.7	4.66	5.2
A-5003-4797	-	M4 STY D2R L50 EWL40 d1.5TC	M4	Ball stylus	2.0	Ruby	50.0	Tungsten carbide	40.0	3.80	5.3
A-5003-4799	-	M4 STY D4R L50 EWL38.5 d2.0TC	M4	Ball stylus	4.0	Ruby	50.0	Tungsten carbide	38.5	4.99	5.3
A-5003-4800	-	M4 STY D5R L50 EWL36 d2.5TC	M4	Ball stylus	5.0	Ruby	50.0	Tungsten carbide	37.9	6.72	5.3
A-5003-4801	-	M4 STY D6R L50 EWL40.7 d2.5TC	M4	Ball stylus	6.0	Ruby	50.0	Tungsten carbide	40.7	6.86	5.3
A-5003-4802	-	M4 STY D8R L75 EWL75 d4.5CE	M4	Ball stylus	8.0	Ruby	75.0	Ceramic	75.0	6.20	5.3
A-5003-4860	-	M3 STY D6R L75 EWL75 d4CF	M3	Ball stylus	6.0	Ruby	75.0	Carbon fibre	75.0	2.40	4.5
A-5003-4861	-	M3 STY D6R L100 EWL100 d4CF	M3	Ball stylus	6.0	Ruby	100.0	Carbon fibre	100.0	2.89	4.5
A-5003-4862	-	M3 STY D8R L75 EWL75 d4CF	M3	Ball stylus	8.0	Ruby	75.0	Carbon fibre	75.0	2.98	4.5
A-5003-4863	-	M3 STY D8R L100 EWL100 d4CF	M3	Ball stylus	8.0	Ruby	100.0	Carbon fibre	100.0	3.47	4.5
A-5003-4864	-	M3 EXT L75 d4CF	M3	Extension	-	-	75.0	Carbon fibre	-	2.53	4.7
A-5003-4865	-	M3 EXT L100 d4CF	M3	Extension	-	-	100.0	Carbon fibre	-	3.02	4.7
A-5003-5061	-	M3 STY D4SN L21 EWL17.2 d2.5SS	M3	Ball stylus	4.0	Silicon nitride	21.0	Stainless steel	17.2	1.3	4.2
A-5003-5201	-	M5 STY D0.3R L20 EWL3 d0.2TC	M5	Ball stylus	0.3	Ruby	20.0	Tungsten carbide	3.0	6.5	6.2
A-5003-5202	-	M5 STY D0.5R L20 EWL4 d0.4TC	M5	Ball stylus	0.5	Ruby	20.0	Tungsten carbide	4.0	6.5	6.2
A-5003-5203	-	M5 STY D0.7R L20 EWL5 d0.5TC	M5	Ball stylus	0.7	Ruby	20.0	Tungsten carbide	5.0	6.5	6.2
A-5003-5204	-	M5 STY D1R L20 EWL5 d0.7TC	M5	Ball stylus	1.0	Ruby	20.0	Tungsten carbide	5.0	6.52	6.3
A-5003-5205	-	M5 STY D1.5R L20 EWL11 d1TC	M5	Ball stylus	1.5	Ruby	20.0	Tungsten carbide	11.0	4.68	6.3
A-5003-5206	-	M5 STY D2R L20 EWL11 d1TC	M5	Ball stylus	2.0	Ruby	20.0	Tungsten carbide	11.0	4.70	6.3
A-5003-5207	-	M5 STY D2.5R L20 EWL11 d1.5TC	M5	Ball stylus	2.5	Ruby	20.0	Tungsten carbide	11.0	4.84	6.3
A-5003-5208	-	M5 STY D3R L20 EWL11 d2TC	M5	Ball stylus	3.0	Ruby	20.0	Tungsten carbide	11.0	5.12	6.3
A-5003-5209	-	M5 STY D4R L20 EWL11.9 d2TC	M5	Ball stylus	4.0	Ruby	20.0	Tungsten carbide	11.9	5.19	6.3
A-5003-5210	-	M5 STY D5R L20 EWL11.5 d3TC	M5	Ball stylus	5.0	Ruby	20.0	Tungsten carbide	11.5	6.06	6.3
A-5003-5211	-	M5 STY D0.3R L30 EWL3 d0.2TC	M5	Ball stylus	0.3	Ruby	30.0	Tungsten carbide	3.0	8.95	6.2
A-5003-5212	-	M5 STY D0.5R L30 EWL4 d0.4TC	M5	Ball stylus	0.5	ruby	30.0	Tungsten carbide	4.0	8.95	6.2
A-5003-5213	-	M5 STY D0.7R L30 EWL5 d0.5TC	M5	Ball stylus	0.7	Ruby	30.0	Tungsten carbide	5.0	8.98	6.2
A-5003-5214	-	M5 STY D1R L30 EWL5 d0.7TC	M5	Ball stylus	1.0	Ruby	30.0	Tungsten carbide	5.0	9.01	6.3
A-5003-5215	-	M5 STY D1.5R L30 EWL12 d1TC	M5	Ball stylus	1.5	Ruby	30.0	Tungsten carbide	12.0	7.28	6.3
A-5003-5216	-	M5 STY D2R L30 EWL21 d1TC	M5	Ball stylus	2.0	Ruby	30.0	Tungsten carbide	21.0	4.81	6.3
A-5003-5217	-	M5 STY D2.5R L30 EWL21 d1.5TC	M5	Ball stylus	2.5	Ruby	30.0	Tungsten carbide	21.0	5.14	6.3
A-5003-5218	-	M5 STY D3R L30 EWL21 d2TC	M5	Ball stylus	3.0	Ruby	30.0	Tungsten carbide	21.0	5.58	6.3
A-5003-5219	-	M5 STY D4R L30 EWL21.9 d2TC	M5	Ball stylus	4.0	Ruby	30.0	Tungsten carbide	21.9	5.64	6.3
A-5003-5220	-	M5 STY D5R L30 EWL21.5 d3TC	M5	Ball stylus	5.0	Ruby	30.0	Tungsten carbide	21.5	7.10	6.3
A-5003-5221	-	M5 STY D1.5R L40 EWL22 d1TC	M5	Ball stylus	1.5	Ruby	40.0	Tungsten carbide	22.0	7.39	6.3
A-5003-5222	-	M5 STY D2R L40 EWL31 d1TC	M5	Ball stylus	2.0	Ruby	40.0	Tungsten carbide	31.0	4.93	6.3
A-5003-5223	-	M5 STY D2.5R L40 EWL31 d1.5TC	M5	Ball stylus	2.5	Ruby	40.0	Tungsten carbide	31.0	5.40	6.3
A-5003-5224	-	M5 STY D3R L40 EWL31 d2TC	M5	Ball stylus	3.0	Ruby	40.0	Tungsten carbide	31.0	6.04	6.3
A-5003-5225	-	M5 STY D0.3R L50 EWL3 d0.2TC	M5	Ball stylus	0.3	Ruby	50.0	Tungsten carbide	3.0	15.79	6.2

Part no.	PS no	Description	Thread	Component	Ball/tip size (mm)	Ball/tip Material	Length (mm)	Stem material	EWL (mm)	Mass (g)	Section no.
A-5003-5226	-	M5 STY D0.5R L50 EWL4 d0.4TC	M5	Ball stylus	0.5	Ruby	50.0	Tungsten carbide	4.0	15.79	6.2
A-5003-5227	-	M5 STY D0.7R L50 EWL5 d0.5TC	M5	Ball stylus	0.7	Ruby	50.0	Tungsten carbide	5.0	15.79	6.2
A-5003-5228	-	M5 STY D1R L50 EWL5 d0.7TC	M5	Ball stylus	1.0	Ruby	50.0	Tungsten carbide	5.0	15.81	6.4
A-5003-5229	-	M5 STY D1.5R L50 EWL5 d1TC	M5	Ball stylus	1.5	Ruby	50.0	Tungsten carbide	5.0	14.82	6.4
A-5003-5230	-	M5 STY D2R L50 EWL41 d1TC	M5	Ball stylus	2.0	Ruby	50.0	Tungsten carbide	41.0	5.05	6.4
A-5003-5231	-	M5 STY D2R L50 EWL5 d1TC	M5	Ball stylus	2.0	Ruby	50.0	Tungsten carbide	5.0	14.85	6.4
A-5003-5232	-	M5 STY D2.5R L50 EWL41 d2TC	M5	Ball stylus	2.5	Ruby	50.0	Tungsten carbide	41.0	6.48	6.4
A-5003-5233	-	M5 STY D2.5R L50 EWL5 d1.5TC	M5	Ball stylus	2.5	Ruby	50.0	Tungsten carbide	5.0	14.94	6.4
A-5003-5234	-	M5 STY D3R L50 EWL41 d2TC	M5	Ball stylus	3.0	Ruby	50.0	Tungsten carbide	41.0	6.50	6.4
A-5003-5235	-	M5 STY D4R L50 EWL41.9 d2TC	M5	Ball stylus	4.0	Ruby	50.0	Tungsten carbide	41.9	6.50	6.4
A-5003-5236	-	M5 STY D5R L50 EWL41.5 d3TC	M5	Ball stylus	5.0	Ruby	50.0	Tungsten carbide	41.5	9.19	6.4
A-5003-5237	-	M5 STY D6R L50 EWL39.5 d4CF	M5	Ball stylus	6.0	Ruby	50.0	Carbon fibre	39.5	6.10	6.4
A-5003-5238	-	M5 STY D8R L50 EWL39.5 d6CF	M5	Ball stylus	8.0	Ruby	50.0	Carbon fibre	39.5	7.96	6.4
A-5003-5239	-	M5 STY D10R L50 EWL44.5 d6CF	M5	Ball stylus	10.0	Ruby	50.0	Carbon fibre	44.5	8.91	6.4
A-5003-5240	-	M5 STY D0.3R L75 EWL3 d0.2TC	M5	Ball stylus	0.3	Ruby	75.0	Tungsten carbide	3.0	23.84	6.2
A-5003-5241	-	M5 STY D0.5R L75 EWL4 d0.4TC	M5	Ball stylus	0.5	Ruby	75.0	Tungsten carbide	4.0	23.84	6.2
A-5003-5242	-	M5 STY D0.7R L75 EWL5 d0.5TC	M5	Ball stylus	0.7	Ruby	75.0	Tungsten carbide	5.0	23.84	6.2
A-5003-5243	-	M5 STY D1R L75 EWL5 d0.7TC	M5	Ball stylus	1.0	Ruby	75.0	Tungsten carbide	5.0	23.86	6.5
A-5003-5244	-	M5 STY D1.5R L75 EWL5 d1TC	M5	Ball stylus	1.5	Ruby	75.0	Tungsten carbide	5.0	23.90	6.5
A-5003-5248	-	M5 STY D4R L75 EWL66 d3TC	M5	Ball stylus	4.0	Ruby	75.0	Tungsten carbide	66.0	11.61	6.5
A-5003-5249	-	M5 STY D5R L75 EWL66 d3TC	M5	Ball stylus	5.0	Ruby	75.0	Tungsten carbide	66.0	11.80	6.5
A-5003-5250	-	M5 STY D6R L75 EWL65.1 d4CF	M5	Ball stylus	6.0	Ruby	75.0	Carbon fibre	65.1	6.59	6.5
A-5003-5251	-	M5 STY D8R L75 EWL64.5 d6CF	M5	Ball stylus	8.0	Ruby	75.0	Carbon fibre	64.5	9.06	6.5
A-5003-5252	-	M5 STY D10R L75 EWL69.5 d6CF	M5	Ball stylus	10.0	Ruby	75.0	Carbon fibre	69.5	10.01	6.5
A-5003-5253	-	M5 STY D3R L100 EWL20 d2TC	M5	Ball stylus	3.0	Ruby	100.0	Tungsten carbide	20.0	25.71	6.6
A-5003-5254	-	M5 STY D3R L100 EWL55 d1.5TC	M5	Ball stylus	3.0	Ruby	100.0	Tungsten carbide	55.0	16.30	6.7
A-5003-5255	-	M5 STY D4R L100 EWL30.5 d2TC	M5	Ball stylus	4.0	Ruby	100.0	Tungsten carbide	30.5	25.75	6.6
A-5003-5256	-	M5 STY D4R L100 EWL50 d3TC	M5	Ball stylus	4.0	Ruby	100.0	Tungsten carbide	50.0	23.07	6.6
A-5003-5257	-	M5 STY D5R L100 EWL50 d3TC	M5	Ball stylus	5.0	Ruby	100.0	Tungsten carbide	50.0	23.31	6.6
A-5003-5258	-	M5 STY D5R L100 EWL91 d3TC	M5	Ball stylus	5.0	Ruby	100.0	Tungsten carbide	91.0	14.40	6.7
A-5003-5259	-	M5 STY D6R L100 EWL58.9 d4CF	M5	Ball stylus	6.0	Ruby	100.0	Carbon fibre	58.9	19.66	6.7
A-5003-5260	-	M5 STY D6R L100 EWL90.1 d4CF	M5	Ball stylus	6.0	Ruby	100.0	Carbon fibre	90.1	7.08	6.7
A-5003-5261	-	M5 STY D8R L100 EWL50 d6CF	M5	Ball stylus	8.0	Ruby	100.0	Carbon fibre	50.0	22.97	6.6
A-5003-5262	-	M5 STY D8R L100 EWL89.5 d6CF	M5	Ball stylus	8.0	Ruby	100.0	Carbon fibre	89.5	10.17	6.7
A-5003-5263	-	M5 STY D10R L100 EWL95.5 d6CF	M5	Ball stylus	10.0	Ruby	100.0	Carbon fibre	95.5	23.91	6.7
A-5003-5264	-	M5 STY D10R L100 EWL94.5 d6CF	M5	Ball stylus	10.0	Ruby	100.0	Carbon fibre	94.5	11.11	6.7
A-5003-5265	-	M5 STY D6R L150 EWL137 d4CF	M5	Ball stylus	6.0	Ruby	150.0	Carbon fibre	137.0	9.09	6.8
A-5003-5266	-	M5 STY D8R L150 EWL135 d6CF	M5	Ball stylus	8.0	Ruby	150.0	Carbon fibre	135.0	13.71	6.8
A-5003-5267	-	M5 STY D10R L150 EWL144.5 D6CF	M5	Ball stylus	10.0	Ruby	150.0	Carbon fibre	144.5	14.66	6.8
A-5003-5268	-	M5 STY D6R L200 EWL187 d4CF	M5	Ball stylus	6.0	Ruby	200.0	Carbon fibre	187.0	10.07	6.8
A-5003-5269	-	M5 STY D8R L200 EWL180 d6CF	M5	Ball stylus	8.0	Ruby	200.0	Carbon fibre	180.0	15.92	6.8
A-5003-5270	-	M5 STY D10R L200 EWL194.50 d6CF	M5	Ball stylus	10.0	Ruby	200.0	Carbon fibre	194.5	16.87	6.8
A-5003-5271	-	M5 STY D6R L300 EWL287 d4CF	M5	Ball stylus	6.0	Ruby	300.0	Carbon fibre	287.0	12.02	6.9
A-5003-5272	-	M5 STY D8R L300 EWL280 d6CF	M5	Ball stylus	8.0	Ruby	300.0	Carbon fibre	280.0	20.33	6.9
A-5003-5273	-	M5 STY D10R L300 EWL294.5 d6CF	M5	Ball stylus	10.0	Ruby	300.0	Carbon fibre	294.5	21.28	6.9
A-5003-5275	-	M5 HEM D16CE d7SS	M5	Hemispherical	16.0	Ceramic	19.5	Stainless steel	-	7.0	6.16
A-5003-5276	-	M5 HEM D22CE d7SS	M5	Hemispherical	22.0	Ceramic	20.5	Stainless steel	-	14.0	6.16
A-5003-5277	-	M5 HEM D30CE d7SS	M5	Hemispherical	30.0	Ceramic	24.5	Stainless steel	-	19.7	6.16
A-5003-5278	-	M5 ACC KNUCKLE d11 ROTARY	M5	Accessory	-	-	36.5	Stainless steel	-	16.5	8.2
A-5003-5279	-	M5 ACC KNUCKLE d20 ROTARY	M5	Accessory	-	-	46.5	Stainless steel	-	64.9	8.2
A-5003-5288	-	M5 DSC D12SLVS T3 L3 BR-Y5	M5	Disc	12.0	Silver steel	3.0	Stainless steel	3.0	2.52	6.16
A-5003-5289	-	M5 DSC D21SLVS T3 L3 BR-Y5	M5	Disc	21.0	Silver steel	3.0	Stainless steel	3.0	5.23	6.16
A-5003-5290	-	M5 DSC D35SLVS T5 L4 BR-Y8	M5	Disc	35.0	Silver steel	4.0	Stainless steel	5.0	14.0	6.16
A-5003-5291	-	M5 DSC D63.5SLVS T5 L4 BR-Y8	M5	Disc	63.5	Silver steel	4.0	Stainless steel	5.0	51.00	6.16
A-5003-5676	-	M5 ACC CUBE BOLT L33	M5	Accessory	-	-	33.0	Stainless steel	-	6.4	8.4
A-5003-5677	-	M5 ACC CUBE BOLT L28	M5	Accessory	-	-	28.0	Stainless steel	-	6.0	8.4
A-5003-5678	-	M5-M2 ACC CUBE BOLT L33	M5	Accessory	-	-	33.0	Stainless steel	-	7.1	8.4
A-5003-5679	-	M5-M2 ACC CUBE BOLT L28	M5	Accessory	-	-	28.0	Stainless steel	-	6.7	8.4
A-5003-5683	-	M5-M2 15x15 CUBE	M5	Accessory	-	-	15.0	Titanium	-	13.75	8.4
A-5003-5684	-	M5-M2 20x20 CUBE	M5	Accessory	-	-	20.0	Titanium	-	35.18	8.4

Styli and accessories

Part no.	PS no	Description	Thread	Component	Ball/tip size (mm)	Ball/tip Material	Length (mm)	Stem material	EWL (mm)	Mass (g)	Section no.
A-5003-5723	-	M3 STY D2SN L21 EWL9.6 d1.4SS	M3	Ball stylus	2.0	Silicon nitride	21.0	Stainless steel	9.6	1.0	4.2
A-5003-5724	-	M3 STY D2SN L30 EWL22.8 d1.5TC	M3	Ball stylus	2.0	Silicon nitride	30.0	Tungsten carbide	22.8	1.32	4.3
A-5003-5725	-	M3 STY D4SN L50 EWL46 d2CE	M3	Ball stylus	4.0	Silicon nitride	50.0	Ceramic	46.0	1.24	4.4
A-5003-5726	-	M3 STY D6SN L75 EWL75 d4CF	M3	Ball stylus	6.0	Silicon nitride	75.0	Carbon fibre	75.0	2.4	4.5
A-5003-5727	-	M3 STY D6SN L100 EWL100 d4CF	M3	Ball stylus	6.0	Silicon nitride	100.0	Carbon fibre	100.0	2.89	4.5
A-5003-5728	-	M4 STY D2SN L19 EWL9.2 d1.4SS	M4	Ball stylus	2.0	Silicon nitride	19.0	Stainless steel	9.2	2.30	5.2
A-5003-5729	-	M4 STY D4SN L18 EWL13.7 d3SS	M4	Ball stylus	4.0	Silicon nitride	18.0	Stainless steel	13.7	2.08	5.2
A-5003-5730	-	M4 STY D6SN L50 EWL38.5 d4.5CF	M4	Ball stylus	6.0	Silicon nitride	50.0	Carbon fibre	38.5	4.1	5.5
A-5003-5731	-	M4 STY D6SN L100 EWL88.5 d4.5CF	M4	Ball stylus	6.0	Silicon nitride	100.0	Carbon fibre	88.5	6.2	5.5
A-5003-5732	-	M5 STY D2SN L20 EWL11 d1TC	M5	Ball stylus	2.0	Silicon nitride	20.0	Tungsten carbide	11.0	4.70	6.3
A-5003-5733	-	M5 STY D4SN L20 EWL11.9 d2TC	M5	Ball stylus	4.0	Silicon nitride	20.0	Tungsten carbide	11.9	5.17	6.3
A-5003-5734	-	M5 STY D6SN L50 EWL39.5 d4CF	M5	Ball stylus	6.0	Silicon nitride	50.0	Carbon fibre	39.5	6.02	6.4
A-5003-5735	-	M5 STY D6SN L100 EWL56.9 d4CF	M5	Ball stylus	6.0	Silicon nitride	100.0	Carbon fibre	56.9	19.66	6.7
A-5003-5736	-	M3 STY D2Z L21 EWL9.6 d1.4SS	M3	Ball stylus	2.0	Zirconia	21.0	Stainless steel	9.6	1.0	4.2
A-5003-5737	-	M3 STY D4Z L21 EWL17.2 d2.5SS	M3	Ball stylus	4.0	Zirconia	21.0	Stainless steel	17.2	1.3	4.2
A-5003-5738	-	M3 STY D2Z L30 EWL22.8 d1.5TC	M3	Ball stylus	2.0	Zirconia	30.0	Tungsten carbide	22.8	1.32	4.3
A-5003-5739	-	M3 STY D4Z L50 EWL46 d2CE	M3	Ball stylus	4.0	Zirconia	50.0	Ceramic	46.0	1.24	4.4
A-5003-5740	-	M3 STY D6Z L75 EWL75 d4CF	M3	Ball stylus	6.0	Zirconia	75.0	Carbon fibre	75.0	2.4	4.5
A-5003-5741	-	M3 STY D6Z L100 EWL100 d4CF	M3	Ball stylus	6.0	Zirconia	100.0	Carbon fibre	100.0	2.89	4.5
A-5003-5742	-	M4 STY D2Z L19 EWL9.2 d1.4SS	M4	Ball stylus	2.0	Zirconia	19.0	Stainless steel	9.2	2.3	5.2
A-5003-5743	-	M4 STY D4Z L18 EWL13.7 d3SS	M4	Ball stylus	4.0	Zirconia	18.0	Stainless steel	13.7	2.40	5.2
A-5003-5744	-	M4 STY D6Z L50 EWL38.5 d4.5CF	M4	Ball stylus	6.0	Zirconia	50.0	Carbon fibre	38.5	4.1	5.5
A-5003-5745	-	M4 STY D6Z L100 EWL88.5 d4.4CF	M4	Ball stylus	6.0	Zirconia	100.0	Carbon fibre	88.5	6.2	5.5
A-5003-5746	-	M5 STY D2Z L20 EWL11 d1TC	M5	Ball stylus	2.0	Zirconia	20.0	Tungsten carbide	11.0	4.73	6.3
A-5003-5747	-	M5 STY D4Z L20 EWL11.9 d2TC	M5	Ball stylus	4.0	Zirconia	20.0	Carbon fibre	11.9	4.95	6.3
A-5003-5748	-	M5 STY D6Z L50 EWL39.5 d4CF	M5	Ball stylus	6.0	Zirconia	50.0	Tungsten carbide	39.5	5.49	6.4
A-5003-5749	-	M5 STY D6Z L100 EWL58.9 d4CF	M5	Ball stylus	6.0	Zirconia	100.0	Carbon fibre	58.9	19.66	6.7
A-5003-5909	-	M5 STYLUS KIT - COMPREHENSIVE	M5	Accessory	-	-	-	-	-	-	8.15
A-5003-5910	-	M5 STYLUS KIT - GENERAL PURPOSE	M5	Accessory	-	-	-	-	-	-	8.16
A-5003-5911	-	M5 STYLUS KIT - STANDARD	M5	Accessory	-	-	-	-	-	-	8.14
A-5003-5912	-	M5 STYLUS EXTENSION KIT - 11 MM	M5	Accessory	-	-	-	-	-	-	8.17
A-5003-5913	-	M5 STYLUS EXTENSION KIT - 20 MM	M5	Accessory	-	-	-	-	-	-	8.18
A-5003-6120	PS8R	M2 STY D2SN L10 EWL6 d1SS	M2	Ball stylus	2.0	Silicon nitride	10.0	Stainless steel	6.0	0.3	3.2
A-5003-6134	-	M5 ACC D11 EXTENSION TOOL	-	Accessory	-	-	-	-	-	-	6.10
A-5003-6135	-	M5 ACC D20 EXTENSION TOOL	-	Accessory	-	-	-	-	-	-	6.10
A-5003-6151	-	M3 STY KIT (SP25M/SM25-1/SH25-1)	M3	Accessory	-	-	-	-	-	-	8.9
A-5003-6152	-	M3 STY KIT (SP25M/SM25-2/SH25-2)	M3	Accessory	-	-	-	-	-	-	8.10
A-5003-6153	-	M3 STY KIT (SP25M/SM25-3/SH25-3)	M3	Accessory	-	-	-	-	-	-	8.10
A-5003-6168	-	M5 STYLUS KIT (SP80)	M5	Accessory	-	-	-	-	-	-	8.13
A-5003-6257	-	M3 STY D3SN L21 d1.5SS	M3	Ball stylus	3.0	Silicon nitride	21.0	Stainless steel	14.7	1.0	4.2
A-5003-6510	-	M4 STY D6R L100 EWL88.5 d4.5CF	M4	Ball stylus	6.0	Ruby	100.0	Carbon fibre	88.5	6.2	5.5
A-5003-6511	-	M4 STY D6R L150 EWL138.5 d4.5CF	M4	Ball stylus	6.0	Ruby	150.0	Carbon fibre	138.5	7.5	5.5
A-5003-6512	-	M4 STY D6R L200 EWL188.5 d4.5CF	M4	Ball stylus	6.0	Ruby	200.0	Carbon fibre	188.5	8.7	5.5
A-5003-6691	PS16R	M2 STY D2SN L20 EWL17 d1.SS	M2	Ball stylus	3.0	Silicon nitride	20.0	Stainless steel	17.0	0.5	3.2
A-5003-6695	-	M3 STY D5SN L21 EWL21 d2.5SS	M3	Ball stylus	5.0	Silicon nitride	21.0	Stainless steel	21.0	1.5	4.2
A-5003-6766	-	M3 STY D3Z L30 EWL24 d2TC	M3	Ball stylus	3.0	Zirconia	30.0	Tungsten carbide	24.0	1.83	4.3
A-5003-6767	-	M3 STY D4Z L40 EWL40 d2TC	M3	Ball stylus	4.0	Zirconia	40.0	Tungsten carbide	36.0	2.38	4.4
A-5003-6768	-	M3 STY D4Z L50 EWL46 d2TC	M3	Ball stylus	4.0	Zirconia	50.0	Tungsten carbide	46.0	2.85	4.4
A-5003-6771	-	M3 STY D8Z L75 EWL75 d4CF	M3	Ball stylus	8.0	Zirconia	75.0	Carbon fibre	75.0	2.98	4.5
A-5003-6778	-	M3 STY D8Z L100 EWL100 d4CF	M3	Ball stylus	8.0	Zirconia	100.0	Carbon fibre	100.0	3.47	4.5
A-5003-6985	-	M2 STY D2R L40 EWL32.5 d1.5CER	M2	Ball stylus	2.0	Ruby	40.0	Ceramic	32.5	0.58	3.9
A-5003-7054	-	M3 STY D10R L200 EWL200 d4CF	M3	Ball stylus	10.0	Ruby	200.0	Carbon fibre	200.0	6.47	4.6
A-5003-7055	-	M3 STY D10R L150 EWL150 d4CF	M3	Ball stylus	10.0	Ruby	150.0	Carbon fibre	150.0	5.49	4.6
A-5003-7056	-	M3 STY D10R L100 EWL100 d4CF	M3	Ball stylus	10.0	Ruby	100.0	Carbon fibre	100.0	4.53	4.6
A-5003-7057	-	M3 STY D10R L75 EWL75 d4CF	M3	Ball stylus	10.0	Ruby	75.0	Carbon fibre	75.0	4.05	4.6
A-5003-7098	-	M3 DSC SD30CER T1.5 L5.5 d4TI	M3	Disc stylus	30.0	Ceramic	-	-	-	7.10	4.8
A-5003-7261	-	M2 STY D4Z L10 EWL10 d1.5SS	M2	Ball stylus	4.0	Zirconia	10.0	Stainless steel	10.0	0.4	3.2
A-5003-7269	PS58R	M2 STY D2SN L40 EWL32.5 d1.5TC	M2	Ball stylus	2.0	Silicon nitride	40.0	Tungsten carbide	32.5	1.29	3.5
A-5003-7306	-	M4 STY D6R L50 EWL38.5 d4.5CF	M4	Ball stylus	6.0	Ruby	50.0	Carbon fibre	38.5	4.1	5.5
A-5003-7445	-	M3 STY D12R L100 EWL100 d4CF	M3	Ball stylus	12.0	Ruby	100.0	Carbon fibre	100.0	5.90	4.6

Part no.	PS no	Description	Thread	Component	Ball/tip size (mm)	Ball/tip Material	Length (mm)	Stem material	EWL (mm)	Mass (g)	Section no.
A-5003-7446	-	M3 STY D12R L150 EWL150 d4CF	M3	Ball stylus	12.0	Ruby	150.0	Carbon fibre	150.0	6.90	4.6
A-5003-7447	-	M3 STY D12R L200 EWL200 d4CF	M3	Ball stylus	12.0	Ruby	200.0	Carbon fibre	200.0	7.90	4.6
A-5003-7573	PS53R	M2 STY D2SN L30 EWL22.5 d1.5T	M2	Ball stylus	2.0	Silicon nitride	30.0	Tungsten carbide	22.5	0.99	3.3
A-5003-7665	-	M3 STY D5Z L50 EWL50 d2.5TC	M3	Ball stylus	5.0	Zirconia	50.0	Tungsten carbide	50.0	4.10	4.4
A-5003-7672	-	M2 STY D0.5Z L10 EWL3 d0.3TC	M2	Ball stylus	0.5	Zirconia	10.0	Tungsten carbide	3.0	0.3	3.2
A-5003-7673	-	CONE STYLUS 1.25x20 d3 L57	1¼-20	Cone stylus	3.0	Zirconia	57.0	-	-	-	7.2
A-5003-7674	-	CONE STYLUS 1.25x20 d6 L57	1¼-20	Cone stylus	6.0	Zirconia	57.0	-	-	-	7.2
A-5003-7675	-	CONE STYLUS 1.25x20 d30 PT L75	1¼-20	Cone stylus	-	Zirconia	57.0	-	-	-	7.2
A-5003-7676	-	STYLUS M6 DIA. 125" Z PROBE 0066	M6	Cone stylus	1/8 in.	Zirconia	43.0	-	-	-	7.2
A-5003-7677	-	STYLUS M6 DIA. 25" Z PROBE 0068	M6	Cone stylus	¼ in.	Zirconia	43.0	-	-	-	7.2
A-5003-7678	-	STYLUS M6 DIA 3MM Z PROBE 0065	M6	Cone stylus	3.0	Zirconia	43.0	-	-	-	7.2
A-5003-7679	-	STYLUS M6 DIA 6 MM Z PROBE 0067	M6	Cone stylus	6.0	Zirconia	43.0	-	-	-	7.2
A-5003-7723	-	M2 STY D2Z L10 EWL6 d1SS	M2	Ball stylus	2.0	Zirconia	10.0	Stainless steel	6.0	0.3	3.2
A-5003-7757	-	M2 STY D1Z L10 EWL4.5 d0.7SS	M2	Ball stylus	1.0	Zirconia	10.0	Stainless steel	4.5	0.3	3.2
A-5003-7852	-	M2 STY D3R L30 EWL27.5 d2CF	M2	Ball stylus	3.0	Ruby	30.0	Carbon fibre	27.5	0.45	3.10
A-5003-8091	-	M3 STY D1.5SN L30 E22.5 d1TC	M3	Ball stylus	1.5	Silicon nitride	30.0	Tungsten carbide	22.5	0.93	4.3
A-5003-9190	-	FARO PROBE KIT	-	Accessory	-	-	-	-	-	-	7.3
A-5003-9495	-	M3 STY D10Z L100 EWL100 d4CF	M3	Ball stylus	10.0	Zirconia	100.0	Carbon fibre	100.0	4.53	4.6
A-5003-9500	-	M3 STY D5Z L21 EWL21 d2.5SS	M3	Ball stylus	5.0	Zirconia	21.0	Stainless steel	21.0	1.5	4.2
A-5003-9506	-	M2 STY D3R L50 EWL47 D2CF	M2	Ball stylus	3.0	Ruby	50.0	Carbon fibre	47.0	0.9	3.10
A-5003-9524	PS12R	M2 D4SN L10 EWL10 d1.5SS	M2	Ball stylus	4.0	Silicon nitride	10.0	Stainless steel	10.0	0.4	3.2
A-5004-0154	-	M3 STY D4R L40 EWL36 D2CER	M3	Ball stylus	4.0	Ruby	40.0	Ceramic	36.0	1.2	4.4
A-5004-0165	-	M2 STY D1.5Z L10 EWL4.5 d0.7SS	M2	Ball stylus	1.5	Zirconia	10.0	Stainless steel	4.5	0.3	3.2
A-5004-0210	PS9R	M2 STY D1SN L10 EWL4.5 d0.7SS	M2	Ball stylus	1.0	Silicon nitride	10.0	Stainless steel	4.5	0.3	3.2
A-5004-0236	PS17R	M2 STY D4SN L20 EWL20 d1.5SS	M2	Ball stylus	4.0	Silicon nitride	20.0	Stainless steel	20.0	0.6	3.2
A-5004-0237	PS14R	M2 STY D6SN L10 EWL10 d2.5SS	M2	Ball stylus	6.0	Silicon nitride	10.0	Stainless steel	10.0	0.9	3.2
A-5004-0264	-	M2 STY D3Z L30 EWL27 d2TC	M2	Ball stylus	3.0	Zirconia	30.0	Tungsten carbide	27.0	1.49	3.3
A-5004-0421	-	M3 STY D2R L10 EWL6 D1.5SS	M3	Ball stylus	2.0	Ruby	10.0	Stainless steel	6.0	0.5	4.2
A-5004-0422	-	M3 STY D3R L10 EWL6.5 D1.5SS	M3	Ball stylus	3.0	Ruby	10.0	Stainless steel	6.5	0.5	4.2
A-5004-0423	-	M3 STY D4R L10 EWL7 D2.5SS	M3	Ball stylus	4.0	Ruby	10.0	Stainless steel	7.0	0.7	4.2
A-5004-0435	-	M2 STY D1Z L20 EWL7 d0.7TC	M2	Ball stylus	1.0	Zirconia	20.0	Tungsten carbide	7.0	0.50	3.3
A-5004-0437	-	M2 STY D3Z L20 EWL17.5 d1.5TC	M2	Ball stylus	3.0	Zirconia	20.0	Tungsten carbide	17.0	0.77	3.3
A-5004-0618	-	M2 STY D6Z L30 EWL30 d3CF	M2	Ball stylus	6.0	Zirconia	30.0	Carbon fibre	30.0	0.96	3.4
A-5004-1017	-	M2 STY D2SN L20 EWL14 d1TC	M2	Ball stylus	2.0	Silicon nitride	20.0	Tungsten carbide	14.0	0.48	3.3
A-5004-1021	-	M2 STY D3SN L20 EWL17.5 d1.5TC	M2	Ball stylus	3.0	Silicon nitride	20.0	Tungsten carbide	17.0	0.77	3.3
A-5004-1057	-	M2 STY D3Z L20 EWL17.5 d1.5SS	M2	Ball stylus	3.0	Zirconia	20.0	Stainless steel	17.0	0.5	3.2
A-5004-1058	-	M2 STY D2Z L30 EWL22.5 d1.5TC	M2	Ball stylus	2.0	Zirconia	30.0	Tungsten carbide	22.5	0.99	3.3
A-5004-1059	-	M2 STY D3Z L40 EWL37 d2TC	M2	Ball stylus	3.0	Zirconia	40.0	Tungsten carbide	37.0	1.97	3.5
A-5004-1195	-	M3 STY D4SN L40 EWL36 d2TC	M3	Ball stylus	4.0	Silicon nitride	40.0	Tungsten carbide	36.0	2.38	4.4
A-5004-1198	-	M3 STY D1.5SN L20 EWL12.5 d1TC	M3	Ball stylus	1.5	Silicon nitride	20.0	Tungsten carbide	12.5	0.8	4.3
A-5004-1199	-	M3 STY D3SN L50 EWL43.7 d2TC	M3	Ball stylus	3.0	Silicon nitride	50.0	Tungsten carbide	43.7	2.78	4.4
A-5004-1201	-	M3 STY D5SN L50 EWL50 d2.5TC	M3	Ball stylus	5.0	Silicon nitride	50.0	Tungsten carbide	50.0	4.10	4.4
A-5004-1329	-	M2 STY D6Z L50 EWL50 d3CF	M2	Ball stylus	6.0	Zirconia	50.0	Carbon fibre	50.0	1.2	3.6
A-5004-1330	-	M2 STY D5Z L50 EWL50 d3CF	M2	Ball stylus	5.0	Zirconia	50.0	Carbon fibre	50.0	1.1	3.6
A-5004-1331	-	M2 STY D4Z L50 EWL50 d3CF	M2	Ball stylus	4.0	Zirconia	50.0	Carbon fibre	50.0	1.0	3.6
A-5004-1387	-	M2 DSC SD10SLVS L10 T1.2 BRY	M2	Disc stylus	-	Silver steel	-	Stainless steel	-	1.0	3.12
A-5004-1395	-	M2 DSC SD12SLVS L7.5 T1.6 BRY	M2	Disc stylus	-	Silver steel	-	Stainless steel	-	2.0	3.12
A-5004-1396	-	M2 DSC SD14SLVS L7.5 T1.6 BRY	M2	Disc stylus	-	Silver steel	-	Stainless steel	-	2.5	3.12
A-5004-1508	PS23R	M2 STY D1SN L20 EWL7 d0.7TC	M2	Ball stylus	1.0	Silicon nitride	20.0	Tungsten carbide	7.0	0.50	3.3
A-5004-1519	PS67R	M2 STY D4SN L50 EWL50 d2CE	M2	Ball stylus	4.0	Silicon nitride	50.0	Ceramic	50.0	0.91	3.6
A-5004-1711	-	M2 STY D1.5Z L30 EWL22.5 d1TC	M2	Ball stylus	1.5	Zirconia	30.0	Tungsten carbide	22.5	0.58	3.3
A-5004-1714	-	M2 STY D0.7Z L20 EWL12 d0.5TC	M2	Ball stylus	0.7	Zirconia	20.0	Tungsten carbide	12.0	0.32	3.3
A-5004-1718	-	M3 STY D5SN L40 EWL40 d2.5TC	M3	Ball stylus	5.0	Silicon nitride	40.0	Tungsten carbide	40.0	3.50	4.4
A-5004-1865	-	M4 STY BREAK STEM L15 d2.5	M4	Crash protection device × 10	-	-	15.2	Silver steel	-	4.6	5.10
A-5004-1867	-	M4 CPD L9SLVS	M4	Crash protection device × 10	-	-	9.0	Silver steel	-	1.5	5.10
A-5004-1869	-	M4 CPD L16SLVS	M4	Crash protection device × 10	-	-	16.0	Silver steel	-	2.1	5.10
A-5004-1918	PS24R	M2 STY D1.5SN L10 EWL4.5 d0.7SS	M2	Ball stylus	1.5	Silicon nitride	10.0	Stainless steel	4.5	0.3	3.2
A-5004-1920	PS26R	M2 STY D2.5SN L10 EWL6.5 d1SS	M2	Ball stylus	2.5	Silicon nitride	10.0	Stainless steel	6.5	0.3	3.2
A-5004-1921	PS13R	M2 STY D2SN L10 EWL10 d2.5SS	M2	Ball stylus	5.0	Silicon nitride	10.0	Stainless steel	10.0	0.7	3.2
A-5004-1922	PS15R	M2 STY D8SN L11 EWL11 d2.5SS	M2	Ball stylus	8.0	Silicon nitride	11.0	Stainless steel	11.0	1.5	3.2

Styli and accessories

Part no.	PS no	Description	Thread	Component	Ball/tip size (mm)	Ball/tip Material	Length (mm)	Stem material	EWL (mm)	Mass (g)	Section no.
A-5004-1923	PS27R	M2 STY D2.5SN L20 EWL16.4 d1.4SS	M2	Ball stylus	2.5	Silicon nitride	20.0	Stainless steel	16.4	0.4	3.2
A-5004-1925	PS49R	M2 STY D1.5SN L20 EWL12.5 d1TC	M2	Ball stylus	1.5	Silicon nitride	20.0	Tungsten carbide	12.5	0.50	3.3
A-5004-1928	-	M2 STY D2.5SN L20 EWL15.5 d1TC	M2	Ball stylus	2.5	Silicon nitride	20.0	Tungsten carbide	15.5	0.5	3.3
A-5004-1929	-	M2 STY D4SN L20 EWL20 d2TC	M2	Ball stylus	4.0	Silicon nitride	22.0	Tungsten carbide	22.0	1.24	3.3
A-5004-1930	PS50R	M2 STY D5SN L20 EWL20 d2.5TC	M2	Ball stylus	5.0	Silicon nitride	20.0	Tungsten carbide	20.0	1.98	3.3
A-5004-1931	PS52R	M2 STY D1.5SN L30 EWL22.5 d1TC	M2	Ball stylus	1.5	Silicon nitride	30.0	Tungsten carbide	22.5	0.58	3.3
A-5004-1932	PS54R	M2 STY D2.5SN L30 EWL22.5 d2TC	M2	Ball stylus	2.5	Silicon nitride	30.0	Tungsten carbide	22.5	1.48	3.3
A-5004-1933	PS55R	M2 STY D3SN L30 EWL27 d2TC	M2	Ball stylus	3.0	Silicon nitride	30.0	Tungsten carbide	27.0	1.49	3.3
A-5004-1944	PS56R	M2 STY D4SN L30 EWL30 d2TC	M2	Ball stylus	4.0	Silicon nitride	30.0	Tungsten carbide	30.0	1.57	3.3
A-5004-1945	PS57R	M2 STY D5SN L30 EWL30 d2.5TC	M2	Ball stylus	5.0	Silicon nitride	30.0	Tungsten carbide	30.0	2.57	3.3
A-5004-1946	-	M2 STY D3SN L30 EWL27 d2CE	M2	Ball stylus	3.0	Silicon nitride	30.0	Ceramic	27.0	0.44	3.4
A-5004-1952	-	M2 STY D4SN L30 EWL30 d2CE	M2	Ball stylus	4.0	Silicon nitride	30.0	Ceramic	30.0	0.68	3.4
A-5004-1953	-	M2 STY D5SN L30 EWL30 d2.5CE	M2	Ball stylus	5.0	Silicon nitride	30.0	Ceramic	30.0	0.93	3.4
A-5004-1954	-	M2 STY D6SN L30 EWL30 d2.5CE	M2	Ball stylus	6.0	Silicon nitride	30.0	Ceramic	30.0	1.11	3.4
A-5004-1955	-	M2 STY D4SN L30 EWL30 d2CF	M2	Ball stylus	4.0	Silicon nitride	30.0	Carbon fibre	30.0	0.57	3.4
A-5004-1956	-	M2 STY D5SN L30 EWL30 d3CF	M2	Ball stylus	5.0	Silicon nitride	30.0	Carbon fibre	30.0	0.79	3.4
A-5004-1957	-	M2 STY D6SN L30 EWL30 d3CF	M2	Ball stylus	6.0	Silicon nitride	30.0	Carbon fibre	30.0	0.96	3.4
A-5004-1959	PS59R	M2 STY D2.5SN L40 EWL32.5 d2TC	M2	Ball stylus	2.5	Silicon nitride	40.0	Tungsten carbide	32.5	1.95	3.5
A-5004-1960	PS60R	M2 STY D3SN L40 EWL37 d2TC	M2	Ball stylus	3.0	Silicon nitride	40.0	Tungsten carbide	37.0	1.97	3.5
A-5004-1961	PS61R	M2 STY D4SN L40 EWL40 d2TC	M2	Ball stylus	4.0	Silicon nitride	40.0	Tungsten carbide	40.0	2.04	3.5
A-5004-1962	PS62R	M2 STY D5SN L40 EWL40 d2.5TC	M2	Ball stylus	5.0	Silicon nitride	40.0	Tungsten carbide	40.0	3.17	3.5
A-5004-1963	PS63R	M2 STY D3SN L50 EWL47 d2TC	M2	Ball stylus	3.0	Silicon nitride	50.0	Tungsten carbide	47.0	2.44	3.5
A-5004-1964	PS64R	M2 STY D4SN L50 EWL50 d2TC	M2	Ball stylus	4.0	Silicon nitride	50.0	Tungsten carbide	50.0	2.52	3.5
A-5004-1965	PS65R	M2 STY D5SN L50 EWL50 d2.5TC	M2	Ball stylus	5.0	Silicon nitride	50.0	Tungsten carbide	50.0	3.75	3.5
A-5004-1967	PS66R	M2 STY D3SN L50 EWL47 d2CE	M2	Ball stylus	3.0	Silicon nitride	50.0	Ceramic	47.0	0.83	3.6
A-5004-1968	PS68R	M2 STY D5SN L50 EWL50 d2.5CE	M2	Ball stylus	5.0	Silicon nitride	50.0	Ceramic	50.0	1.31	3.6
A-5004-1969	-	M2 STY D6SN L50 EWL50 d2.5CE	M2	Ball stylus	6.0	Silicon nitride	50.0	Ceramic	50.0	1.49	3.6
A-5004-1970	-	M2 STY D4SN L50 EWL50 d3CF	M2	Ball stylus	4.0	Silicon nitride	50.0	Carbon fibre	50.0	1.0	3.6
A-5004-1971	-	M2 STY D5SN L50 EWL50 d3CF	M2	Ball stylus	5.0	Silicon nitride	50.0	Carbon fibre	50.0	1.1	3.6
A-5004-1972	-	M2 STY D6SN L50 EWL50 d3CF	M2	Ball stylus	6.0	Silicon nitride	50.0	Carbon fibre	50.0	1.2	3.6
A-5004-1973	-	M2 STY D4SN L75 EWL75 d2CF	M2	Ball stylus	4.0	Silicon nitride	75.0	Carbon fibre	75.0	0.75	3.7
A-5004-1974	-	M2 STY D5SN L75 EWL75 d3CF	M2	Ball stylus	5.0	Silicon nitride	75.0	Carbon fibre	75.0	1.35	3.7
A-5004-1975	-	M2 STY D6SN L75 EWL75 d3CF	M2	Ball stylus	6.0	Silicon nitride	75.0	Carbon fibre	75.0	1.45	3.7
A-5004-1976	-	M2 STY D4SN L100 EWL100 d3CF	M2	Ball stylus	4.0	Silicon nitride	100.0	Carbon fibre	100.0	1.50	3.7
A-5004-1977	-	M2 STY D5SN L100 EWL100 d3CF	M2	Ball stylus	5.0	Silicon nitride	100.0	Carbon fibre	100.0	1.59	3.7
A-5004-1978	-	M2 STY D6SN L100 EWL100 d3CF	M2	Ball stylus	6.0	Silicon nitride	100.0	Carbon fibre	100.0	1.78	3.7
A-5004-1979	-	M3 STY D1SN L21 EWL4 d0.7SS	M3	Ball stylus	1.0	Silicon nitride	21.0	Stainless steel	4.0	1.0	4.2
A-5004-1980	-	M3 STY D4SN L31 EWL27 d2.5SS	M3	Ball stylus	4.0	Silicon nitride	31.0	Stainless steel	27.0	2.5	4.2
A-5004-1981	-	M3 STY D5R L31 EWL31 d3.5SS	M3	Ball stylus	5.0	Silicon nitride	31.0	Stainless steel	31.0	3.0	4.2
A-5004-1982	-	M3 STY D2.5SN L20.2 EWL12.5 d2TC	M3	Ball stylus	2.5	Silicon nitride	20.2	Tungsten carbide	12.5	1.3	4.3
A-5004-1983	-	M3 STY D2.5SN L30 EWL22.5 d2TC	M3	Ball stylus	2.5	Silicon nitride	30.0	Tungsten carbide	22.5	1.81	4.3
A-5004-1984	-	M3 STY D3SN L30 EWL24 d2TC	M3	Ball stylus	3.0	Silicon nitride	30.0	Tungsten carbide	24.0	1.83	4.3
A-5004-1985	-	M3 STY D2SN L40 EWL32.5 d1.5TC	M3	Ball stylus	2.0	Ruby	40.0	Tungsten carbide	32.5	1.58	4.4
A-5004-1986	-	M3 STY D2.5SN L40 EWL32.5 d2TC	M3	Ball stylus	2.5	Silicon nitride	40.0	Tungsten carbide	32.5	2.28	4.4
A-5004-1987	-	M3 STY D3SN L40 EWL33.7 d2TC	M3	Ball stylus	3.0	Silicon nitride	40.0	Tungsten carbide	33.7	2.30	4.4
A-5004-1988	-	M3 STY D4SN L50 EWL46 d2TC	M3	Ball stylus	4.0	Silicon nitride	50.0	Tungsten carbide	46.0	2.85	4.4
A-5004-1989	-	M3 STY D3SN L50 EWL43.7 d2CE	M3	Ball stylus	3.0	Silicon nitride	50.0	Ceramic	43.7	1.17	4.4
A-5004-1990	-	M3 STY D5SN L50 EWL50 d2.5CE	M3	Ball stylus	5.0	Silicon nitride	50.0	Ceramic	50.0	1.33	4.4
A-5004-1991	-	M3 STY D8SN L75 EWL75 d4CF	M3	Ball stylus	8.0	Silicon nitride	75.0	Carbon fibre	75.0	2.98	4.5
A-5004-1992	-	M3 STY D10SN L75 EWL75 d4CF	M3	Ball stylus	10.0	Silicon nitride	75.0	Carbon fibre	75.0	4.05	4.6
A-5004-1993	-	M3 STY D10SN L100 EWL100 d4CF	M3	Ball stylus	10.0	Silicon nitride	100.0	Carbon fibre	100.0	4.53	4.6
A-5004-1994	-	M3 STY D10SN L150 EWL150 d4CF	M3	Ball stylus	10.0	Silicon nitride	150.0	Carbon fibre	150.0	5.49	4.6
A-5004-1995	-	M3 STY D10SN L200 EWL200 d4CF	M3	Ball stylus	10.0	Silicon nitride	200.0	Carbon fibre	200.0	6.47	4.6
A-5004-1996	-	M3 STY D12SN L100 EWL100 d4CF	M3	Ball stylus	12.0	Silicon nitride	100.0	Carbon fibre	100.0	5.90	4.6
A-5004-1997	-	M3 STY D12SN L150 EWL150 d4CF	M3	Ball stylus	12.0	Silicon nitride	150.0	Carbon fibre	150.0	6.90	4.6
A-5004-1998	-	M3 STY D12SN L200 EWL200 d4CF	M3	Ball stylus	12.0	Silicon nitride	200.0	Carbon fibre	200.0	7.90	4.6
A-5004-2016	PS29R	M2 STY D0.3SN L10 EWL2 d0.2TC	M2	Ball stylus	0.3	Silicon nitride	10.0	Tungsten carbide	2.0	0.3	3.2
A-5004-2018	-	M2 STY D1SN L10 EWL4 d0.7TC	M2	Ball stylus	1.0	Silicon nitride	10.0	Tungsten carbide	4.0	0.3	3.2
A-5004-2019	-	M2 STY D0.5SN L20 EWL7 d0.3TC	M2	Ball stylus	0.5	Silicon nitride	20.0	Tungsten carbide	7.0	0.48	3.3
A-5004-2021	PS48R	M2 STY D1SN L20 EWL12.5 d0.8TC	M2	Ball stylus	1.0	Silicon nitride	20.0	Tungsten carbide	12.5	0.41	3.3

Part no.	PS no	Description	Thread	Component	Ball/tip size (mm)	Ball/tip Material	Length (mm)	Stem material	EWL (mm)	Mass (g)	Section no.
A-5004-2022	PS51R	M2 STY D1SN L27.5 EWL20.5 d0.7TC	M2	Ball stylus	1.0	Silicon nitride	27.5	Tungsten carbide	20.5	0.40	3.3
A-5004-2023	-	M3 STY D0.5SN L21 EWL2 d0.4TC	M3	Ball stylus	0.5	Silicon nitride	21.0	Tungsten carbide	2.0	1.0	4.3
A-5004-2203	-	M2 STY D6Z L10 EWL10 d2.5SS	M2	Ball stylus	6.0	Zirconia	10.0	Stainless steel	10.0	0.9	3.2
A-5004-2442	-	M3 STY D1R L20 EWL12.5 D0.7TC	M3	Ball stylus	1.0	Ruby	20.0	Tungsten carbide	12.5	0.7	4.3
A-5004-2545	-	M3 STY D2.5R L40 EWL32.5 D2CER	M3	Ball stylus	2.5	Ruby	40.0	Ceramic	32.5	1.1	4.4
A-5004-2632	-	M2 STY D0.7Z L10 EWL4 d0.5TC	M2	Ball stylus	0.7	Zirconia	10.0	Tungsten carbide	4.0	0.3	3.2
A-5004-2913	-	M2 STY D2.5Z L10 EWL6.5 d1SS	M2	Ball stylus	2.5	Zirconia	10.0	Stainless steel	6.5	0.3	3.2
A-5004-2914	-	M2 STY D3Z L10 EWL7.5 d1.5SS	M2	Ball stylus	3.0	Zirconia	10.0	Stainless steel	7.0	0.4	3.2
A-5004-2915	-	M2 STY D8Z L11 EWL11 d2.5SS	M2	Ball stylus	8.0	Zirconia	11.0	Stainless steel	11.0	1.5	3.2
A-5004-2916	-	M2 STY D2Z L20 EWL14 d1.4SS	M2	Ball stylus	2.0	Zirconia	20.0	Stainless steel	14.0	0.4	3.2
A-5004-2917	-	M2 STY D2.5Z L20 EWL16.4 d1.4SS	M2	Ball stylus	2.5	Zirconia	20.0	Stainless steel	16.4	0.4	3.2
A-5004-2918	-	M2 STY D4Z L20 EWL20 d1.4SS	M2	Ball stylus	4.0	Zirconia	20.0	Stainless steel	20.0	0.6	3.2
A-5004-2919	-	M2 STY D1Z L10 EWL4 d0.7TC	M2	Ball stylus	1.0	Zirconia	10.0	Tungsten carbide	4.0	0.3	3.2
A-5004-2920	-	M2 STY D0.5Z L20 EWL7 d0.3TC	M2	Ball stylus	0.5	Zirconia	20.0	Tungsten carbide	7.0	0.48	3.3
A-5004-2921	-	M2 STY D1Z L20 EWL12.5 d0.8TC	M2	Ball stylus	1.0	Zirconia	20.0	Tungsten carbide	12.5	0.41	3.3
A-5004-2922	-	M2 STY D1.5Z L20 EWL12.5 d1TC	M2	Ball stylus	1.5	Zirconia	20.0	Tungsten carbide	12.5	0.50	3.3
A-5004-2923	-	M2 STY D2Z L20 EWL14 d1TC	M2	Ball stylus	2.0	Zirconia	20.0	Tungsten carbide	14.0	0.48	3.3
A-5004-2924	-	M2 STY D2.5Z L20 EWL15.5 d1TC	M2	Ball stylus	2.5	Zirconia	20.0	Tungsten carbide	15.5	0.5	3.3
A-5004-2925	-	M2 STY D4Z L22 EWL22 d2TC	M2	Ball stylus	4.0	Zirconia	22.0	Tungsten carbide	22.0	1.24	3.3
A-5004-2926	-	M2 STY D5Z L20 EWL20 d2.5TC	M2	Ball stylus	5.0	Zirconia	20.0	Tungsten carbide	20.0	1.98	3.3
A-5004-2927	-	M2 STY D1Z L27.5 EWL20.5 d0.7TC	M2	Ball stylus	1.0	Zirconia	27.5	Tungsten carbide	20.5	0.40	3.3
A-5004-2928	-	M2 STY D2.5Z L30 EWL22.5 d2TC	M2	Ball stylus	2.5	Zirconia	30.0	Tungsten carbide	22.5	1.48	3.3
A-5004-2929	-	M2 STY D4Z L30 EWL30 d2TC	M2	Ball stylus	4.0	Zirconia	30.0	Tungsten carbide	30.0	1.57	3.3
A-5004-2930	-	M2 STY D5Z L30 EWL30 d2.5TC	M2	Ball stylus	5.0	Zirconia	30.0	Tungsten carbide	30.0	2.57	3.3
A-5004-2931	-	M2 STY D3Z L30 EWL27 d2CE	M2	Ball stylus	3.0	Zirconia	30.0	Ceramic	27.0	0.44	3.4
A-5004-2932	-	M2 STY D4Z L30 EWL30 d2CE	M2	Ball stylus	4.0	Zirconia	30.0	Ceramic	30.0	0.68	3.4
A-5004-2933	-	M2 STY D5Z L30 EWL30 d2.5CE	M2	Ball stylus	5.0	Zirconia	30.0	Ceramic	30.0	0.93	3.4
A-5004-2934	-	M2 STY D6Z L30 EWL30 d2.5CE	M2	Ball stylus	6.0	Zirconia	30.0	Ceramic	30.0	1.11	3.4
A-5004-2935	-	M2 STY D4Z L30 EWL30 d2CF	M2	Ball stylus	4.0	Zirconia	30.0	Carbon fibre	30.0	0.57	3.4
A-5004-2936	-	M2 STY D5Z L30 EWL30 d3CF	M2	Ball stylus	5.0	Zirconia	30.0	Carbon fibre	30.0	0.79	3.4
A-5004-2937	-	M2 STY D2Z L40 EWL32.5 d1.5TC	M2	Ball stylus	2.0	Zirconia	40.0	Tungsten carbide	32.5	1.29	3.5
A-5004-2938	-	M2 STY D2.5Z L40 EWL32.5 d2TC	M2	Ball stylus	2.5	Zirconia	40.0	Tungsten carbide	32.5	1.95	3.5
A-5004-2939	-	M2 STY D4Z L40 EWL40 d2TC	M2	Ball stylus	4.0	Zirconia	40.0	Tungsten carbide	40.0	2.04	3.5
A-5004-2940	-	M2 STY D5Z L40 EWL40 d2.5TC	M2	Ball stylus	5.0	Zirconia	40.0	Tungsten carbide	40.0	3.17	3.5
A-5004-2942	-	M2 STY D3Z L50 EWL47 d2TC	M2	Ball stylus	3.0	Zirconia	50.0	Tungsten carbide	47.0	2.44	3.5
A-5004-2943	-	M2 STY D4Z L50 EWL50 d2TC	M2	Ball stylus	4.0	Zirconia	50.0	Tungsten carbide	50.0	2.52	3.5
A-5004-2944	-	M2 STY D5Z L50 EWL50 d2.5TC	M2	Ball stylus	5.0	Zirconia	50.0	Tungsten carbide	50.0	3.75	3.5
A-5004-2945	-	M2 STY D3Z L50 EWL47 d2CE	M2	Ball stylus	3.0	Zirconia	50.0	Ceramic	47.0	0.83	3.6
A-5004-2946	-	M2 STY D4Z L50 EWL50 d2CE	M2	Ball stylus	4.0	Zirconia	50.0	Ceramic	50.0	0.91	3.6
A-5004-2947	-	M2 STY D5Z L50 EWL50 d2.5CE	M2	Ball stylus	5.0	Zirconia	50.0	Ceramic	50.0	1.31	3.6
A-5004-2948	-	M2 STY D6Z L50 EWL50 d2.5CE	M2	Ball stylus	6.0	Zirconia	50.0	Ceramic	50.0	1.49	3.6
A-5004-2949	-	M2 STY D4Z L75 EWL75 d2CF	M2	Ball stylus	4.0	Zirconia	75.0	Carbon fibre	75.0	0.75	3.7
A-5004-2950	-	M2 STY D5Z L75 EWL75 d3CF	M2	Ball stylus	5.0	Zirconia	75.0	Carbon fibre	75.0	1.35	3.7
A-5004-2951	-	M2 STY D6Z L75 EWL75 d3CF	M2	Ball stylus	6.0	Zirconia	57.0	Carbon fibre	75.0	1.45	3.7
A-5004-2952	-	M2 STY D4Z L100 EWL100 d3CF	M2	Ball stylus	4.0	Zirconia	100.0	Carbon fibre	100.0	1.50	3.7
A-5004-2953	-	M2 STY D5Z L100 EWL100 d3CF	M2	Ball stylus	5.0	Zirconia	100.0	Carbon fibre	100.0	1.59	3.7
A-5004-2954	-	M2 STY D6Z L100 EWL100 d3CF	M2	Ball stylus	6.0	Zirconia	100.0	Carbon fibre	100.0	1.78	3.7
A-5004-2955	-	M3 STY D1Z L21 EWL4 d0.7SS	M3	Ball stylus	1.0	Zirconia	21.0	Stainless steel	4.0	1.0	4.2
A-5004-2956	-	M3 STY D3Z L21 EWL14.7 d1.5SS	M3	Ball stylus	3.0	Zirconia	21.0	Stainless steel	14.7	1.0	4.2
A-5004-2957	-	M3 STY D4Z L31 EWL27 d2.5SS	M3	Ball stylus	4.0	Zirconia	31.0	Stainless steel	27.0	2.5	4.2
A-5004-2958	-	M3 STY D5Z L31 EWL31 d3.5SS	M3	Ball stylus	5.0	Zirconia	31.0	Stainless steel	31.0	3.0	4.2
A-5004-2959	-	M3 STY D0.5Z L21 EWL2 d0.4TC	M3	Ball stylus	0.5	Zirconia	21.0	Tungsten carbide	2.0	1.0	4.3
A-5004-2960	-	M3 STY D1.5Z L20 EWL12.5 d1TC	M3	Ball stylus	1.5	Zirconia	20.0	Tungsten carbide	12.5	0.8	4.3
A-5004-2961	-	M3 STY D2.5Z L20.2 EWL12.5 d2TC	M3	Ball stylus	2.5	Zirconia	20.2	Tungsten carbide	12.5	1.3	4.3
A-5004-2962	-	M3 STY D1.5Z L30 EWL22.5 d1TC	M3	Ball stylus	1.5	Zirconia	30.0	Tungsten carbide	22.5	0.93	4.3
A-5004-2963	-	M3 STY D2.5Z L30 EWL22.5 d2TC	M3	Ball stylus	2.5	Zirconia	30.0	Tungsten carbide	22.5	1.81	4.3
A-5004-2964	-	M3 STY D2.5Z L40 EWL32.5 d2TC	M3	Ball stylus	2.5	Zirconia	40.0	Tungsten carbide	32.5	2.28	4.4
A-5004-2965	-	M3 STY D3Z L40 EWL33.7 d2TC	M3	Ball stylus	3.0	Zirconia	40.0	Tungsten carbide	33.7	2.30	4.4
A-5004-2966	-	M3 STY D5Z L40 EWL40 d2.5TC	M3	Ball stylus	5.0	Zirconia	40.0	Tungsten carbide	40.0	3.50	4.4
A-5004-2968	-	M3 STY D3Z L50 EWL43.7 d2TC	M3	Ball stylus	3.0	Zirconia	50.0	Tungsten carbide	43.7	2.78	4.4

Styli and accessories

Part no.	PS no	Description	Thread	Component	Ball/tip size (mm)	Ball/tip Material	Length (mm)	Stem material	EWL (mm)	Mass (g)	Section no.
A-5004-2969	-	M3 STY D3Z L50 EWL43.7 d2CE	M3	Ball stylus	3.0	Zirconia	50.0	Ceramic	43.7	1.17	4.4
A-5004-2970	-	M3 STY D5Z L50 EWL50 d2.5CE	M3	Ball stylus	5.0	Zirconia	50.0	Ceramic	50.0	1.33	4.4
A-5004-2972	-	M3 STY D10Z L75 EWL75 d4CF	M3	Ball stylus	10.0	Zirconia	75.0	Carbon fibre	75.0	4.05	4.6
A-5004-2973	-	M3 STY D10Z L150 EWL150 d4CF	M3	Ball stylus	10.0	Zirconia	150.0	Carbon fibre	150.0	5.49	4.6
A-5004-2974	-	M3 STY D10Z L200 EWL200 d4CF	M3	Ball stylus	10.0	Zirconia	200.0	Carbon fibre	200.0	6.47	4.6
A-5004-2975	-	M3 STY D12Z L100 EWL100 d4CF	M3	Ball stylus	12.0	Zirconia	100	Carbon fibre	100.0	5.90	4.6
A-5004-2976	-	M3 STY D12Z L150 EWL150 d4CF	M3	Ball stylus	12.0	Zirconia	150.0	Carbon fibre	150.0	6.90	4.6
A-5004-2977	-	M3 STY D12Z L200 EWL200 d4CF	M3	Ball stylus	12.0	Zirconia	200.0	Carbon fibre	200.0	7.90	4.6
A-5004-3404	-	M2 STY D2R L30 EWL22.5 D1.5CER	M2	Ball stylus	2.0	Ruby	30.0	Ceramic	22.5	0.51	3.9
A-5004-3646	-	M3 STY D2R L40 EWL32.5 D1.5CER	M3	Ball stylus	2.0	Ruby	40.0	Ceramic	32.5	0.9	4.4
A-5004-3728	-	M3 HEM D18CER L12	M3	Hemispherical	18.0	Ceramic	12.0	Stainless steel	-	4.0	4.8
A-5004-4447	-	M2 SCREW KIT	M2	Accessory	-	-	-	-	-	-	8.2
A-5004-4472	-	M4 STY D6R L100 EWL83.5 D3.8CER	M4	Ball stylus	6.0	Ruby	100.0	Ceramic	83.5	6.5	5.7
A-5004-4474	-	M4 STY D6R L150 EWL133.5 D3.8CER	M4	Ball stylus	6.0	Ruby	150.0	Ceramic	133.5	8.0	5.7
A-5004-5131	-	M2 STARTER KIT	-	Accessory	-	-	-	-	-	-	8.8
A-5004-5132	-	M4 STYLUS STARTER KIT	M4	Accessory	-	-	-	-	-	-	8.12
A-5004-5370	-	M4 CYL D1TC L20 EWL10	M4	Cylinder	1.0	Tungsten carbide	20.0	Tungsten carbide	10.0	2.5	5.10
A-5004-5466	-	M3 STY D8SN L100 EWL100 d4CF	M3	Ball stylus	8.0	Silicon nitride	100.0	Carbon fibre	100.0	3.47	4.5
A-5004-6040	-	M3 STY D3R L40 EWL32.5 D2C	M3	Ball stylus	3.0	Ruby	40.0	Ceramic	32.5	1.1	4.4
A-5004-6463	-	M4 STY D2R L80 EWL21.8 D1.5TC	M4	Ball stylus	2.0	Ruby	80.0	Ceramic/TC	21.8	5.9	5.8
A-5004-6464	-	M4 STY D3R L100 EWL41.8 D2TC	M4	Ball stylus	3.0	Ruby	100.0	Ceramic/TC	41.8	7.4	5.8
A-5004-6465	-	M4 STY D4R L100 EWL41.8 D2TC	M4	Ball stylus	4.0	Ruby	100.0	Ceramic/TC	41.8	7.4	5.8
A-5004-6467	-	M4 STY D2R L80 EWL21.8 D1.5TC	M4	Ball stylus	2.0	Ruby	80.0	Ceramic/TC	21.8	5.9	5.8
A-5004-6468	-	M4 STY D3R L100 EWL41.8 D2TC	M4	Ball stylus	3.0	Ruby	100.0	Ceramic/TC	41.8	7.4	5.8
A-5004-6469	-	M4 STY D4R L100 EWL41.8 D2TC	M4	Ball stylus	4.0	Ruby	100.0	Ceramic/TC	41.8	7.4	5.8
A-5004-6470	-	M4 STY D6SIN L100 EWL83.5 D3.8CER	M4	Ball stylus	6.0	Silicon nitride	100.0	Ceramic	83.5	6.5	5.7
A-5004-6471	-	M4 STY D6SIN L150 EWL133.5 D3.8CER	M4	Ball stylus	6.0	Silicon nitride	150.0	Ceramic	133.5	8.0	5.7
A-5004-6723	-	M4 CPD L16SLVS	M4	Crash protection device	-	-	16.0	Silver steel	-	2.1	5.10
A-5004-6735	-	M3 STY D5R L40 EWL40 D2.5CER	M3	Ball stylus	5.0	Ruby	40.0	Ceramic	40.0	1.7	4.4
A-5004-6880	-	M3 STARTER KIT	-	Accessory	-	-	-	-	-	-	8.9
A-5004-7123	-	M2 STY D2SN L40 EWL32.5 D1.5CR	M2	Ball stylus	2.0	Silicon nitride	40.0	Ceramic	32.5	0.58	3.9
A-5004-7235	-	STYLUS CLEANING KIT	-	Accessory	-	-	-	-	-	-	8.22
A-5004-7273	-	M2 STY D2SIN L30 EWL22.5 D1.5C	M2	Ball stylus	2.0	Silicon nitride	30.0	Ceramic	22.5	0.51	3.9
A-5004-7398	-	M2 STY D0.3R L20 EWL2 D0.2TC	M2	Ball stylus	0.3	Ruby	20.0	Tungsten carbide	2.0	0.5	3.3
A-5004-7399	-	M2 STY D0.3SIN L20 EWL2 D0.2TC	M2	Ball stylus	0.3	Silicon nitride	20.0	Tungsten carbide	2.0	0.5	3.3
A-5004-7400	-	M2 HEM D30 CER L18	M2	Hemispherical	30.0	Ceramic	18.0	Stainless steel	-	14.5	3.15
A-5004-7401	-	M3 STY D1R L10 EWL4 SS	M3	Ball stylus	1.0	Ruby	10.0	Stainless steel	4.0	0.6	4.2
A-5004-7402	-	M3 STY D3R L20 EWL14 D2TC	M3	Ball stylus	3.0	Ruby	20.0	Tungsten carbide	14.0	1.4	4.3
A-5004-7403	-	M3 SCREW KIT	M3	Accessory	-	-	-	-	-	-	8.2
A-5004-7582	-	M2-M3 STYLUS TOOL	-	Accessory	-	-	-	-	-	-	8.4
A-5004-7583	SE2	M3 EXT L20 D4SS	M3	Extension	-	-	20.0	Stainless steel	-	1.6	4.7
A-5004-7584	SE3	M3 EXT L35 D4SS	M3	Extension	-	-	35.0	Stainless steel	-	2.9	4.7
A-5004-7585	SE4	M2 EXT L10 D3SS	M2	Extension	-	-	10.0	Stainless steel	-	0.4	3.14
A-5004-7586	SE5	M2 EXT L20 D3SS	M2	Extension	-	-	20.0	Stainless steel	-	0.9	3.14
A-5004-7587	-	M4 STYLUS TOOL	-	Accessory	-	-	-	-	-	-	8.4
A-5004-7588	PS20R	M2 PNT D3SLVS 30DEG L15	M2	Pointer	0.1	Silver steel	15.0	Silver steel	-	0.7	3.15
A-5004-7589	PS18R	M2 CYL D1.5SLVS L10.75 EWL1.25	M2	Cylinder	1.5	Silver steel	10.75	Silver steel	1.25	0.3	3.13
A-5004-7590	-	M2 CYL D3SLVS L12.75 EWL3.8	M2	Cylinder	3.0	Silver steel	12.75	Silver steel	3.8	0.6	3.13
A-5004-7591	SE6	M2 EXT L30 D3SS	M2	Extension	-	-	30.0	Stainless steel	-	1.4	3.14
A-5004-7592	SA3	M3-M2 EXT L5SS	M3	Extension	-	-	5.0	Stainless steel	-	0.6	8.3
A-5004-7593	SA2	M2-M3 EXT L7SS	M2	Extension	-	-	7.0	Stainless steel	-	0.4	8.3
A-5004-7594	-	M4 STR 5WAY L15	M4	Star centre	-	-	15.0	-	-	10.0	5.6
A-5004-7595	SA5	M4-M2 EXT L5SS	M4	Extension	-	-	5.0	Stainless steel	-	1.5	8.3
A-5004-7596	SE21	M4-M3 EXT L20SS	M4	Extension	-	-	20.0	Stainless steel	-	3.2	8.3
A-5004-7597	SA6	M4-M3 EXT L9SS	M4	Extension	-	-	9.0	Stainless steel	-	1.4	8.3
A-5004-7598	SA-8	M4 CPD L8SS	M4	Crash protection device	-	-	8.0	Stainless steel	-	1.8	5.10
A-5004-7599	SE-9	M4 EXT L10 d7SS	M4	Extension	-	-	10.0	Stainless steel	-	2.4	5.16
A-5004-7600	-	M4 EXT L15 d7SS	M4	Extension	-	-	15.0	Stainless steel	-	3.7	5.16
A-5004-7601	SE-1	M4 EXT L20 d7SS	M4	Extension	-	-	20.0	Stainless steel	-	4.8	5.16
A-5004-7602	SE-12	M4 EXT L30 d7SS	M4	Extension	-	-	30.0	Stainless steel	-	7.4	5.16

Part no.	PS no	Description	Thread	Component	Ball/tip size (mm)	Ball/tip Material	Length (mm)	Stem material	EWL (mm)	Mass (g)	Section no.
A-5004-7603	SS2	M4 CPD L8 CRANK SS	M4	Crash protection device	-	-	8.0	Stainless steel	-	1.4	5.10
A-5004-7604	SS3	M4 CPD L8SS SWIVEL L10	M4	Crash protection device	-	-	10.0	Stainless steel	-	1.5	5.10
A-5004-7605	CR-1	M4 CEX SS L1-5 L2-21.9	M4	Cranked extension	-	-	21.9	Stainless steel	-	6.07	5.6
A-5004-7606	CR-2	M4 CEX SS L1-5 L2-27.6	M4	Cranked extension	-	-	27.6	Stainless steel	-	6.94	5.6
A-5004-7607	SW-1	M4 ACC SWIVEL L1-10 L2-12.5	M4	Accessory	-	-	10.0	Stainless steel	-	2.76	5.6
A-5004-7608	SW-2	M4 ACC SWIVEL L1-13.5 L2-16	M4	Accessory	-	-	13.5	Stainless steel	-	3.70	5.6
A-5004-7609	SE8	M3 EXT L10 D4SS	M3	Extension	-	-	10.0	Stainless steel	-	0.9	4.7
A-5004-7610	SE7	M2 EXT L5 D3SS	M2	Extension	-	-	5.0	Stainless steel	-	0.2	3.14
A-5004-7611	SE18	M2 EXT L40 D3SS	M2	Extension	-	-	40.0	Stainless steel	-	1.8	3.14
A-5004-7612	SATF6	TF6-M3 EXT L18SS	TF6	Extension	-	-	18.0	Stainless steel	-	1.9	8.3
A-5004-7613	-	M5-M4 EXT L6.5SS	M5	Extension	-	-	6.5	Stainless steel	-	6.0	8.3
A-5004-7614	-	M5 STYLUS TOOL	-	Accessory	-	-	-	-	-	-	8.4
A-5004-7616	-	M3 CPD L13.3SLVS	M3	Crash protection device	-	-	13.35	Silver steel	-	2.43	5.10
A-5004-7618	-	M3 CPD L22.3SLVS	M3	Crash protection device	-	-	22.35	Silver steel	-	3.6	5.10
A-5004-7619	-	M3 CPD L30.3 SLVS	M3	Crash protection device	-	-	30.35	Silver steel	-	4.5	5.10
A-5004-7620	-	STYLUS BREAK STEM	M4	Crash protection device	-	-	13.50	Silver steel	-	1.37	5.10
A-5004-7621	-	M4 CPD L12SLVS	M4	Crash protection device	-	-	12.0	Silver steel	-	2.7	5.10
A-5004-7622	-	BREAK STEM	M4	Crash protection device	-	-	19.0	Silver steel	-	2.2	5.10
A-5004-7624	-	M4 CPD L9SLVS	M4	Crash protection device	-	-	9.0	Silver steel	-	1.5	5.10
A-5465-5001	-	M4 STY D2R L80 EWL21.8 D1.5TC	M4	Ball stylus	2.0	Ruby	80.0	Ceramic/TC	21.8	5.9	5.8
A-5465-5002	-	M4 STY D3R L100 EWL 41.8 D2TC	M4	Ball stylus	3.0	Ruby	100.0	Ceramic/TC	41.8	7.4	5.8
A-5465-5003	-	M4 STY D4R L100 EWL41.8 D2TC	M4	Ball stylus	4.0	Ruby	100.0	Ceramic/TC	41.8	7.4	5.8
A-5465-5005	-	M4 STY D2R L80 EWL21.8 D1.5TC	M4	Ball stylus	2.0	Ruby	80.0	Ceramic/TC	21.8	5.9	5.8
A-5465-5006	-	M4 STY D3R L100 EWL 41.8 D2TC	M4	Ball stylus	3.0	Ruby	100.0	Ceramic/TC	41.8	7.4	5.8
A-5465-5007	-	M4 STY D4R L100 EWL41.8 D2TC	M4	Ball stylus	4.0	Ruby	100.0	Ceramic/TC	41.8	7.4	5.8
A-5465-5008	-	M4 STY D6SIN L100 EWL83.5 D3.8CER	M4	Ball stylus	6.0	Silicon nitride	100.0	Ceramic	83.5	6.5	5.7
A-5465-5009	-	M4 STY D6SIN L150 EWL133.5 D3.8CER	M4	Ball stylus	6.0	Silicon nitride	150.0	Ceramic	133.5	8.0	5.7
A-5465-8576	-	M4 STY D6R L100 EWL83.5 D3.8CER	M4	Ball stylus	6.0	Ruby	100.0	Ceramic	83.5	6.5	5.7
A-5465-8577	-	M4 STY D6R L150 EWL133.5 D3.8CER	M4	Ball stylus	6.0	Ruby	150.0	Ceramic	133.5	8.0	5.7
A-5472-3000	-	3D TOOL SETTER DISC STYLUS KIT	M4	Tool setter	-	-	-	-	-	34.0	5.9
A-5504-0281	-	EQUATOR STY KIT BASIC	-	Accessory	-	-	-	-	-	-	8.19
A-5504-0282	-	EQUATOR STY KIT INTERMEDIATE	-	Accessory	-	-	-	-	-	-	8.20
A-5504-0283	-	EQUATOR STYLI KIT ADVANCED	-	Accessory	-	-	-	-	-	-	8.21
A-5555-0125	-	M5 EXT L200 d20AL	M5	Extension	-	-	200.0	Aluminium	-	85.0	6.15
A-5555-0127	-	M5 EXT L100 d20AL	M5	Extension	-	-	100.0	Aluminium	-	50.0	6.15
A-5555-0136	-	M5 EXT L100 d11SS	M5	Extension	-	-	100.0	Stainless steel	-	73.0	6.14
A-5555-0140	-	M5 EXT L20 d11SS	M5	Extension	-	-	20.0	Stainless steel	-	13.0	6.14
A-5555-0142	-	M5 EXT L10 d11SS	M5	Extension	-	-	10.0	Stainless steel	-	6.0	6.14
A-5555-0189	-	M5 ACC 15x15 CUBE	M5	Accessory	-	-	15.0	Titanium	-	12.85	8.4
A-5555-0190	-	M5 ACC 20x20 CUBE	M5	Accessory	-	-	20.0	Titanium	-	32.55	8.4
A-5555-0194	-	M5 ACC 40x20 DOUBLE CUBE	M5	Accessory	-	-	40.0	Titanium	-	63.50	8.4
A-5555-0226	-	M5M-M2F L10 D11	M5	Adaptor	-	-	10.0	Stainless steel	-	5.0	8.3
A-5555-0227	-	M5M-M3F L10 D11	M5	Adaptor	-	-	10.0	Stainless steel	-	5.0	8.3
A-5555-0297	-	M2 DSC D8 B1.5 L32 ML19 DS1.5	M2	Disc	-	Ceramic	32.0	Tungsten carbide	-	1.0	3.12
A-5555-0298	-	M2 DSC D4 B1 L32 ML19 DS1	M2	Disc	-	Ceramic	32.0	Tungsten carbide	-	1.0	3.12
A-5555-0299	-	M2 DSC SD14CER B2 L5	M2	Disc	-	Ceramic	5.0	Stainless Steel	-	1.0	3.12
A-5555-0300	-	M2 DSC SD20CER B2.5 L5	M2	Disc	-	Ceramic	5.0	Stainless steel	-	3.8	3.12
A-5555-0424	-	M5 EXT L150 d11CF	M5	Extension	-	-	150.0	Carbon fibre	-	15.4	6.11
A-5555-0425	-	M5 EXT L120 d11CF	M5	Extension	-	-	120.0	Carbon fibre	-	13.2	6.11
A-5555-0427	-	M5 EXT L250 d20CF	M5	Extension	-	-	250.0	Carbon fibre	-	52.9	6.13
A-5555-0620	-	M5 EXT L40 d20CF	M5	Extension	-	-	40.0	Carbon fibre	-	23.8	6.12
A-5555-0621	-	M5 EXT L80 d20CF	M5	Extension	-	-	80.0	Carbon fibre	-	29.3	6.12
A-5555-0623	-	M5 EXT L70 d11CF	M5	Extension	-	-	70.0	Carbon fibre	-	9.7	6.10
A-5555-0642	-	M5 EXT L300 d11CF	M5	Extension	-	-	300.0	Carbon fibre	-	25.9	6.11
A-5555-0647	-	M5 EXT L40 d11CF	M5	Extension	-	-	40.0	Carbon fibre	-	7.6	6.10
A-5555-0648	-	M5 EXT L50 d11CF	M5	Extension	-	-	50.0	Carbon fibre	-	8.3	6.10
A-5555-0649	-	M5 EXT L60 d11CF	M5	Extension	-	-	60.0	Carbon fibre	-	9.0	6.10
A-5555-0650	-	M5 EXT L80 d11CF	M5	Extension	-	-	80.0	Carbon fibre	-	10.4	6.10
A-5555-0651	-	M5 EXT L90 d11CF	M5	Extension	-	-	90.0	Carbon fibre	-	11.1	6.10
A-5555-0652	-	M5 EXT L100 d11CF	M5	Extension	-	-	100.0	Carbon fibre	-	11.8	6.10

About Renishaw

Renishaw is an established world leader in engineering technologies, with a strong history of innovation in product development and manufacturing. Since its formation in 1973, the company has supplied leading-edge products that increase process productivity, improve product quality and deliver cost-effective automation solutions.

A worldwide network of subsidiary companies and distributors provides exceptional service and support for its customers.

Products include:

- Additive manufacturing and vacuum casting technologies for design, prototyping, and production applications
- Dental CAD/CAM scanning systems and supply of dental structures
- Encoder systems for high-accuracy linear, angle and rotary position feedback
- Fixturing for CMMs (co-ordinate measuring machines) and gauging systems
- Gauging systems for comparative measurement of machined parts
- High-speed laser measurement and surveying systems for use in extreme environments
- Laser and ballbar systems for performance measurement and calibration of machines
- Medical devices for neurosurgical applications
- Probe systems and software for job set-up, tool setting and inspection on CNC machine tools
- Raman spectroscopy systems for non-destructive material analysis
- Sensor systems and software for measurement on CMMs
- Styli for CMM and machine tool probe applications

For worldwide contact details, visit www.renishaw.com/contact



RENISHAW HAS MADE CONSIDERABLE EFFORTS TO ENSURE THE CONTENT OF THIS DOCUMENT IS CORRECT AT THE DATE OF PUBLICATION BUT MAKES NO WARRANTIES OR REPRESENTATIONS REGARDING THE CONTENT. RENISHAW EXCLUDES LIABILITY, HOWSOEVER ARISING, FOR ANY INACCURACIES IN THIS DOCUMENT.

© 2002–2020 Renishaw plc. All rights reserved.

Renishaw reserves the right to change specifications without notice.

RENISHAW and the probe symbol used in the RENISHAW logo are registered trade marks of Renishaw plc in the United Kingdom and other countries.

apply innovation and names and designations of other Renishaw products and technologies are trade marks of Renishaw plc or its subsidiaries.

All other brand names and product names used in this document are trade names, trade marks or registered trade marks of their respective owners.



H - 1000 - 3200 - 16

Part no.: H-1000-3200-16-C

Issued: 07.2020