

Reshaping  
your  
world.

**NORTON**

SAINT-GOBAIN

**CATALOG #7362**

FULL-LINE STOCK CATALOG  
ABRASIVE PRODUCTS FOR  
THE INDUSTRIAL MARKET

BECAUSE **RIGHT CHOICES** MATTER™

  
SAINT-GOBAIN



Reshaping  
your  
world.

### Our Mission

We offer powerful, precise, user-friendly solutions, which enable our customers to cut, shape and finish all materials even in the most complex and challenging applications. By working closely with end-users and our grinding expert partners, we design and provide customized solutions to secure the best option for performance, cost and safety.

### Our Expertise

Norton is the leading brand of Saint-Gobain Abrasives, with more than 135 years of experience in manufacturing abrasives.

We are committed to providing access to our expert's knowledge whenever you need it. Whether it is through our [Process Solutions Program \(PSP\)](#), ongoing training programs, or through on-line expert articles and white papers you can stay up-to-date with Norton where and when you need it.

Bring us your grinding challenges, we have solutions!

### Our Commitment

You be the final judge in performance! We are so confident of the superior performance of our abrasive products, as recommended for specific applications, that we invite in-plant tests against any other brand of abrasive product on the market. Contact your Norton Representative to find out more about our No Risk test policy or visit [www.nortonabrasives.com](http://www.nortonabrasives.com)



### Why Tiers Matter

At Norton we believe in delivering right choices that matter. Our abrasives are classified in BEST, BETTER, and GOOD performance/price tiers to help you choose the right product for your specific application every time.

#### BEST

Our BEST tier products are designed for the customer who is seeking the highest productivity at the lowest total cost.

#### BETTER

Our BETTER tier products provide an excellent blend of performance and price.

#### GOOD

And, our GOOD tier products promise the highest quality you expect from the Norton name with a low initial price.

If you need help determining the right tier for your specific needs, don't hesitate to contact us directly or reach out to your Norton sales representative.

### Go Further

Visit our website at [www.nortonabrasives.com](http://www.nortonabrasives.com) for a more comprehensive outline of products, safety and application information. We continually update it with our most current information.

Connect with us:



### METAL FAB CUTTING AND GRINDING

Rough Grinding	
Depressed Center Wheels . . . . .	<b>7</b>
Cut-off Wheels	
Small Diameter Reinforced Cut-off . . . . .	<b>17</b>
Circular Saw Reinforced Cut-off . . . . .	<b>24</b>
Chop Saw Reinforced Cut-off . . . . .	<b>25</b>
High-Speed Reinforced Cut-Off . . . . .	<b>28</b>
Walk-Behind Reinforced Cut-off . . . . .	<b>30</b>
Stationary Saw Reinforced Cut-off . . . . .	<b>31</b>
Toolroom Cut-off . . . . .	<b>32</b>
Metallurgical Non-Reinforced Cut-off . . . . .	<b>34</b>
Rail Reinforced Cut-off . . . . .	<b>35</b>
Foundry Wheels	
Foundry Cut-off . . . . .	<b>36</b>
Portable Snagging . . . . .	<b>38</b>
Floorstand and Swingframe Snagging . . . . .	<b>42</b>

### COATED AND NON-WOVEN ABRASIVES

Coated Abrasive Basics . . . . .	<b>45</b>
Non-Woven Abrasive Basics . . . . .	<b>48</b>
Discs	
Fiber Discs . . . . .	<b>50</b>
Flap Discs . . . . .	<b>55</b>
Non-Woven Discs . . . . .	<b>61</b>
Non-Woven Depressed Center Discs . . . . .	<b>63</b>
Non-Woven Standard Back-up Pad Discs . . . . .	<b>65</b>
Non-Woven Speed-Change Discs . . . . .	<b>67</b>
Non-Woven Hook and Loop Discs . . . . .	<b>68</b>
Cloth PSA Discs and Accessories . . . . .	<b>69</b>
Paper Discs . . . . .	<b>72</b>
Mesh Discs . . . . .	<b>81</b>
Film and Foam Finishing Discs . . . . .	<b>82</b>
Flexible Diamond-Coated Discs . . . . .	<b>84</b>
Sanding Accessories . . . . .	<b>85</b>
Wheels	
Non-Woven Convolute Wheels . . . . .	<b>88</b>
Belts	
File Belts . . . . .	<b>93</b>
Portable Belts . . . . .	<b>96</b>
Narrow Belts . . . . .	<b>98</b>
Wide Belts . . . . .	<b>104</b>
FastTrack Service Made-to-Order Belts . . . . .	<b>106</b>
Non-Woven Belts . . . . .	<b>107</b>
Rolls / Sheets	
Cloth Rolls and Sheets . . . . .	<b>109</b>
Paper Rolls and Sheets . . . . .	<b>112</b>
Non-Woven Rolls . . . . .	<b>121</b>
Sponges / Hand Pads	
Abrasive Sponges . . . . .	<b>122</b>
Non-Woven Hand Pads and Sponges . . . . .	<b>124</b>
Foam Hand Pads . . . . .	<b>126</b>
Flexible Diamond-Coated Hand Pads . . . . .	<b>127</b>

### PORTABLE TOOLS AND SPECIALTIES

Mini Angle Sander . . . . .	<b>129</b>
Mini Flap Discs . . . . .	<b>130</b>
Quick-Change Discs . . . . .	<b>131</b>
Non-Woven Quick-Change Discs . . . . .	<b>139</b>
Quick-Change Disc Accessories . . . . .	<b>147</b>
Die Grinder . . . . .	<b>148</b>
Cartridge Rolls . . . . .	<b>149</b>
Spiral Rolls . . . . .	<b>152</b>
Square/Cross Pads, Overlap Slotted Discs . . . . .	<b>155</b>
Spiral Bands . . . . .	<b>159</b>
Tapered Cone Points . . . . .	<b>162</b>
Mandrels . . . . .	<b>163</b>
Test Kits . . . . .	<b>164</b>
Non-Woven Specialties . . . . .	<b>165</b>
Flap Wheels . . . . .	<b>167</b>
Non-Woven Flap Wheels . . . . .	<b>179</b>
Arbor Hole (Gangable) Discs . . . . .	<b>181</b>
Bore Polishers . . . . .	<b>182</b>
FlexDrums . . . . .	<b>184</b>
Non-Woven Unified Wheels . . . . .	<b>188</b>
Mounted Points . . . . .	<b>192</b>
Carbide Burrs . . . . .	<b>193</b>

### PRECISION OFFHAND/PORTABLE

Mounted Points . . . . .	<b>198</b>
Sharpening Stones . . . . .	<b>204</b>
Retail Dressing Sticks and Stones . . . . .	<b>217</b>
Rubbing Bricks . . . . .	<b>218</b>

### PRECISION GRINDING WHEELS

Bonded Abrasives Basics . . . . .	<b>220</b>
Bench and Pedestal Wheels . . . . .	<b>222</b>
Sawgumming Wheels . . . . .	<b>226</b>
Toolroom Vitrified Wheels . . . . .	<b>227</b>
Large Surface Grinding Wheels . . . . .	<b>243</b>
Surface Grinding Segments . . . . .	<b>244</b>
Cylindrical Wheels . . . . .	<b>246</b>
Centerless and Feed Wheels . . . . .	<b>250</b>
Creepfeed Blank Stock FastTrack Service . . . . .	<b>254</b>
Quantum Blank Stock FastTrack Service . . . . .	<b>256</b>
55A Blank Stock FastTrack Service . . . . .	<b>257</b>
Gear Wheel Blank Stock FastTrack Service . . . . .	<b>258</b>
ID, Race and Superfinishing Wheels/Sticks . . . . .	<b>260</b>

### DRESSING SOLUTIONS

Diamond Stationary Dressing Tools . . . . .	<b>263</b>
Diamond Stationary Fliesen Tools . . . . .	<b>281</b>
Diamond Rotary Dressing Tools . . . . .	<b>284</b>
Truing Devices . . . . .	<b>285</b>
Dressing Sticks . . . . .	<b>286</b>
Truing and Dressing Guide . . . . .	<b>288</b>

### DIAMOND AND cBN ABRASIVES

Diamond / cBN Basics . . . . .	<b>290</b>
Diamond / cBN Wheels . . . . .	<b>295</b>
B99 Express Resin Bond Wheels . . . . .	<b>305</b>
Diamond / cBN CNC Wheels . . . . .	<b>307</b>
Electroplated Products . . . . .	<b>313</b>
Diamond Lapping Compound . . . . .	<b>322</b>

### CONSTRUCTION PRODUCTS

Diamond Blades . . . . .	<b>324</b>
Diamond Cup Grinders . . . . .	<b>329</b>
Diamond Core Bits . . . . .	<b>330</b>
Equipment . . . . .	<b>331</b>

### WIRE BRUSHES

Wire Brush Basics . . . . .	<b>334</b>
Wire Brushes . . . . .	<b>336</b>
Nylon Brushes . . . . .	<b>347</b>

### MASKING PRODUCTS

Tape . . . . .	<b>349</b>
Masking Film, Paper, and Sheeting . . . . .	<b>352</b>
Micro-Fiber Cloths . . . . .	<b>353</b>

### SAFETY

Safety Icons . . . . .	<b>6</b>
Safety Leadership / References . . . . .	<b>354</b>
Safety Icon Meanings . . . . .	<b>355</b>
Coated Abrasive Do's and Don'ts . . . . .	<b>357</b>
Portable Grinding Safety . . . . .	<b>358</b>
Starting a Grinding Wheel / Ring Test . . . . .	<b>359</b>
Wheel Speed Conversion Table . . . . .	<b>360</b>
Silica Precautions . . . . .	<b>361</b>

### GENERAL INFORMATION

Catalog Navigation . . . . .	<b>4</b>
Machine Index . . . . .	<b>4</b>
Product Warranties . . . . .	<b>362</b>
Trademarks . . . . .	<b>362</b>
Contact Information . . . . .	<b>363</b>
Abrasive Connection . . . . .	<b>363</b>
Norton Tech . . . . .	<b>363</b>
Merchandising . . . . .	<b>363</b>

# Machine Index and Catalog Navigation

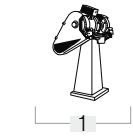

1

**1. Backstand Belt Grinders**  
Coated Abrasive Backstand Belts . . . . . 98–99, 103, 106  
Non-Woven Backstand Belts . . . . . 107–108

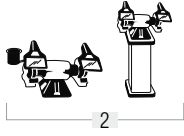

2

**2. Bench and Pedestal Grinders**  
Coated Abrasive Large Diameter Flap Wheels . . . . . 175–177  
Non-Woven Convolute Wheels (6"–14" wheels) . . . . . 88–92  
Non-Woven Discs (6"–12" discs) . . . . . 181  
Non-Woven Flap Wheels (6"–8" wheels) . . . . . 179–180  
Non-Woven Nylon Wheel Brushes . . . . . 347  
Non-Woven Unified Wheels (6" wheels) . . . . . 188–191  
Sand-O-Flex Wheels . . . . . 178  
Vitriified Bench and Pedestal Wheels . . . . . 222–225  
Wire Brushes . . . . . 338–340



3

**3. Benchstand Grinders**  
Coated Abrasive Benchstand Belts . . . . . 98–102, 106  
Non-Woven Benchstand Belts . . . . . 107–108



4

**4. Chop Saw Machines**  
Chop Saw Reinforced Cut-off Wheels . . . . . 25–27



5

**5. Circular Saws**  
Circular Saw Diamond Blades . . . . . 327  
Circular Saw Reinforced Cut-off Wheels . . . . . 24

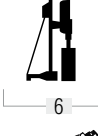

6

**6. Core Drills**  
Diamond Core Bits . . . . . 330

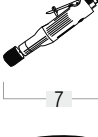

7

**7. Die and Pencil Grinders**  
Carbide Burrs . . . . . 193–196  
Coated Abrasive Small Diameter Flap Wheels . . . . . 167–173, 177  
Coated Abrasive Specialties . . . . . 130–138, 147, 148–164  
Mounted Points . . . . . 192, 198–203  
Non-Woven Specialties . . . . . 165–166  
Non-Woven Flap Wheels (2"–4" wheels) . . . . . 179–180  
Non-Woven Nylon Twisted Brushes . . . . . 347  
Non-Woven Surface Strip and Unified Wheels (1"–4" wheels) . . . . . 188–191  
Wire Brushes . . . . . 334–342



8

**8. Drills**  
Sand-O-Flex Wheels . . . . . 178  
Small Diameter Reinforced Cut-off Wheels (2" and 3" wheels with mandrel) . . . . . 17–21



9

**9. Fixed Rail Saws**  
Rail Reinforced Cut-off Wheels . . . . . 35

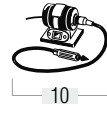

10

**10. Flexible Shaft Motors**  
Non-Woven Rapid Strip Wheels . . . . . 188–189  
Non-Woven Unified Wheels . . . . . 188–191



11

**11. Hand Finishing Applications**  
Coated Abrasive Paper Discs . . . . . 86  
Coated Abrasive Sheets, Rolls and Sponges . . . . . 109–123  
Flexible Diamond Coated Hand Pads . . . . . 127  
Micro-Fiber Cloths, Masking Tape . . . . . 349–353  
Non-Woven Hand Pads, Rolls and Sponges . . . . . 121, 124–126  
Sharpening Stones and Rubbing Bricks . . . . . 204–218  
Dressing Sticks . . . . . 286–287  
Diamond Lapping Compound . . . . . 322  
Wire Brushes . . . . . 346

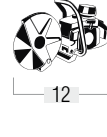

12

**12. High-Speed Gas or Electric Saws**  
High-Speed Reinforced Cut-off Wheels . . . . . 28–29  
High-Speed Saw Diamond Blades . . . . . 325–326  
High-Speed Saws . . . . . 331

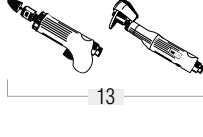

13

**13. Horizontal/Straight Shaft Portable Grinders**  
Coated Abrasive Flap Wheels with Arbor Holes (3-1/2"–5" wheels) . . . . . 174–175, 177  
Cones and Plugs . . . . . 38–39, 41  
Mounted Points . . . . . 192, 198–203  
Non-Woven Disc Wheels . . . . . 181  
Non-Woven Flap Wheels . . . . . 179–180  
Non-Woven Unified Wheels . . . . . 188–191  
Snagging Straight Wheels . . . . . 38–40



14

**14. In-Line Drum Sanders**  
Coated Abrasive Portable Belts . . . . . 96–97  
Non-Woven Portable Belts . . . . . 107–108

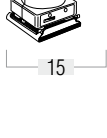

15

**15. Jitterbug Sanders**  
Coated Abrasive Sheets and Rolls . . . . . 109–120  
Non-Woven Rolls . . . . . 121  
Non-Woven Hand Pads . . . . . 124–125

## Easy-to-Follow Page Guide

Key Questions to Simplify Product Selection

Am I in the right section?

- A** Product
- B** Category overview
- C** General attributes
- D** Correct machine use

How do I narrow choices?

- E** Product design variations

How do I match my end-user needs?

- F** Application recommendations
- G** Best/Better/Good performance color coding
- H** Full application / grit guide

How do I match or upgrade from a competitive product?

- I** Cross reference guide



# Machine Index and Catalog Navigation

     	<p><b>16. Masonry Saws</b> Large, Compact, and Portable Masonry Saws ..... 325</p> <p><b>17. Orbital Sanders</b> Coated Abrasive Paper Discs ..... 72-80 Coated Abrasive Small Diameter Cloth PSA Discs ..... 69-70 Film and Foam Finishing Discs ..... 82-83 Flexible Diamond Coated PSA Discs ..... 84 Mesh Discs ..... 81</p> <p><b>18. Portable Belt Sanders</b> Coated Abrasive Portable Belts ..... 96-97 Non-Woven Portable Belts ..... 107-108</p> <p><b>19. Portable Cut-off Tool</b> Small Diameter Reinforced Cut-off Wheels (1-1/2"-4" wheels) ..... 17-21</p> <p><b>20. Portable File Belt Sanders</b> Coated Abrasive File Belts ..... 93-95 Non-Woven File Belts ..... 107-108</p> <p><b>21. Right Angle/Vertical Shaft Portable Grinders</b> Coated Abrasive Fiber Discs ..... 50-54 Coated Abrasive Film and Foam Finishing Discs ..... 82-83 Coated Abrasive Flap Discs ..... 55-60 Coated Abrasive Paper Discs ..... 72-80 Coated Abrasive Quick-Change Discs ..... 131-138 Depressed Center Grinding Wheels, Notchers, Saucers and Type 29 Wheels ..... 8-16 Diamond Blades ..... 327 Flexible Diamond PSA &amp; Quick-Change Discs ..... 84 Non-Woven Depressed Center Discs ..... 61-64 Non-Woven Discs ..... 65-68, 139-147 Non-Woven Nylon Disc Brushes ..... 347 Non-Woven Nylon Stem Mounted and End Brushes ..... 341-345 Pneumatic Air Tool ..... 129 Right Angle Grinder Reinforced Cut-off Wheels, Type 01/41 and Type 27/42 ..... 17-20, 22-23 Wire Brushes ..... 338-340</p>	     	<p><b>22. Right Angle/Vertical Shaft Portable Cup Grinders</b> Diamond Cup Grinders ..... 329 Non-Woven Nylon Cup Brushes ..... 347 Snagging Cup Wheels ..... 38-40 Wire Cup Brushes ..... 334-337</p> <p><b>23. Sanding Boards</b> Sanding Boards and Coated Abrasive File Strips ..... 115</p> <p><b>24. Saw Gumming</b> Saw Gumming Wheels ..... 226</p> <p><b>25. Stationary Chop Saws</b> Large Diameter Reinforced Cut-off Wheels ..... 31</p> <p><b>26. Stationary Disc Sanders</b> Coated Abrasive Large Diameter Cloth PSA Discs (10"-24" discs) ..... 69, 71</p> <p><b>27. Walk-Behind Saws</b> Diamond Blades ..... 328 Reinforced Cut-off Wheels ..... 30 Walk-Behind Push Saws ..... 331 Wire Brushes ..... 339</p>
---	--	--	--

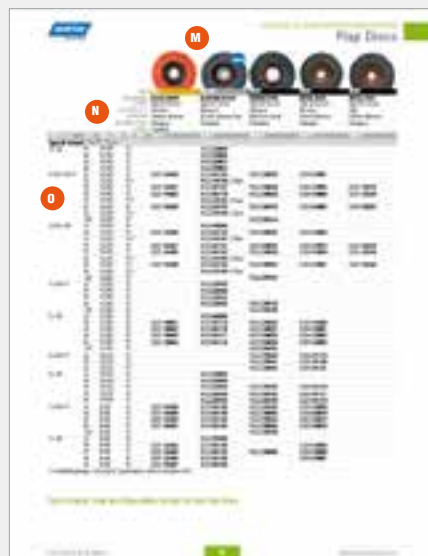

What are the Leading Products by Tier?

- J** Tiers by color-coding: Best, Better, Good
- K** Features and benefits
- L** New, improved, and/or expanded offering

How Do I Find What I Want Now That I Know What I Want?

- M** Visual identification
- N** Key product attributes
- O** Full specification and product number

**⚠ WARNING**

**Improper use of abrasive products might cause grinding wheel breakage and serious injury. Comply with ANSI B7.1, OSHA and Safety Guide furnished with package. Don't overspeed, abuse, or drop wheel. Always use a guard, personal protective equipment and proper mounting procedures.**



**Speeds**

Check machine spindle speed and speed listed on machine against safe maximum operating speed marked on the grinding wheel. Do not overspeed the wheel.

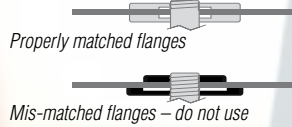

**Flanges**

When mounting most grinding wheels, use flanges of equal diameter and bearing surface. For exceptions, see ANSI B7.1.



**Safety Gloves**

Grinding applications are conducted in harsh environments. The use of proper fitting gloves is recommended.



**Wheel Guard**

Always use the wheel guard as supplied by the machine manufacturer, in the proper position.



**Do Not Use Damaged Wheel**

Always check each wheel for cracks or damage before use. Never use a damaged wheel.



**Eye/Face Protection**

Always wear government-approved face and eye protection when using abrasive products.



**Hearing Protection**

Use of abrasive products can create elevated sound levels. Hearing protection must be worn where required.



**Safety Guides, SDS and Wheel Warning Messages**

Before using any abrasive materials, READ:

- The Safety Guides
- Wheel Warning Messages
- Safety Data Sheets (SDS)

All Norton products provide information pertaining to safe use. Please take the time to read it carefully. Contact suppliers of the workpiece and abrasive materials for copies of the SDS if one is not readily available. Norton abrasives SDS can be obtained on [www.nortonabrasives.com](http://www.nortonabrasives.com)



**Dust Protection**

Exposure to dust generated from workpiece and/or abrasive materials can result in lung damage and/or other physical injury.

Use dust capture or local exhaust as stated in the SDS. Wear government-approved respiratory protection and eye and skin protection. Failure to follow this warning can result in serious lung damage and/or physical injury.

This is a general dust warning and does not cover specific situations. For more information, refer to the SDS dust warning provided with your products, and workpiece.

**Please see pages 354 - 360 for additional safety information**



when the going  
gets rough

**RELY ON  
NORTON INNOVATION**

For stock removal, rough blending,  
cleaning castings and welds...Norton  
depressed center wheels are  
constructed to tackle the demanding  
work of all material types.



Depressed center wheels may also be referred to as raised hub wheels or by their shape designation of "Type", with Type 27 being the most popular. The depressed center design allows the flange/lock nut to recess within the wheel so that it can be used for various grinding and cutting applications. Depressed center wheels are designed to handle the most severe right angle grinding applications from heavy stock removal to rough blending. More recently, depressed center wheels have been designed to increase the utility of the tool for cut-off applications. While large right angle grinders (7" & 9") have been around for many years, small or mini grinders that handle 4", 4-1/2", 5", and 6" wheels have made this machine, and wheel category, the most popular in power tools.

- Applications:** Grinding, stock removal, edge chamfering, beveling, weld blending, and cutting-off
- Size Range:** 2" – 9"
- Thickness Range:** .040" – 1/4"
- Grit Range:** 24 – 46 grits for stock removal; 60, 80 grits for blending and finishing
- Abrasive Grain:** Ceramic Alumina, Diamond, Zirconia Alumina, Aluminum Oxide, Silicon Carbide
- Mounting Options:** Plain hole (3/8", 5/8" and 7/8") and discard mount (5/8"-11)
- Shape:** Type 27, Type 28, Type 29
- Machine Used:**  RIGHT ANGLE GRINDER

## How to Pick the Right Wheel

DEPRESSED CENTER WHEEL DESCRIPTION CODES						
BLANK = All Purpose	ALU = Aluminum	FC = Fast Cut	HD = Heavy Duty	INOX/SS = Contaminant Free	LL = Long Life	XXL = Extra Long Life
■ = Aluminum	■ = Foundry	■ = Masonry	■ = Stainless	■ = Steel / Metal		

DESCRIPTION CODE DEFINITIONS	
BLANK = All Purpose	Where an excellent blend of cut rate and life is needed.
ALU = Aluminum	Specially formulated bond for reduced loading and surface contamination while cutting aluminum and soft materials.
FC = Fast Cut	Where fast stock removal is needed, or the application only allows for low-pressure or under-horsepowered grinders.
HD = Heavy Duty	Triple reinforced for the most aggressive foundry applications
INOX/SS = Contaminate Free	Contain <0.1% iron, sulfur or chlorine for rust-free and corrosion-free results. Will not contaminate stainless steel.
LL = Long Life	Where durability is needed due to severe application, and when horsepower of the grinder allows for heavy pressure.
XXL = Extra Long Life	Offers 50% more life and metal removal than standard aluminum oxide wheels.

## How to Pick the Right Mount

Most wheel sizes come with a plain hole or a discard mount option. While the plain hole has a small, initial cost advantage, the discard mount can provide a labor cost advantage with the quicker wheel change.



### Mini-Mount Hub

Our unique, patented mini-mount hub used on 4-1/2" and 5" depressed center wheels provides up to 30% more wheel life because the hub covers just a small surface area, providing maximum grinding area exposure and usage.

Standard throw-away hub size

## Why Choose Depressed Center Wheels?

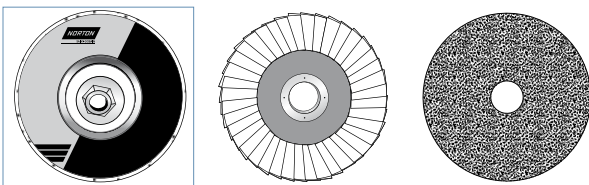

### Depressed Center Wheels vs. Flap Discs or Fiber Discs

- Up to 5X life over flap discs, less downtime and inventory
- Up to 100X life over fiber discs, less downtime and inventory
- Rigidity for severe operations and high power grinders
- 1/8" wheels can be used for cutting and grinding
- Can be used to grind inside corners at outer edge of wheel

## Mounting Depressed Center Wheels



See how to correctly mount a depressed center wheel on our youtube page at <https://nortonsga.us/7hc5m>

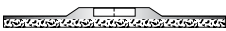
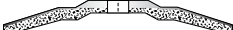
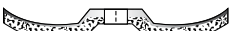

## Type-To-Application Recommendation Guide

Wheel Type/Thickness	Applications	90° ANGLE	30° ANGLE	15° ANGLE
 <b>TYPE 27</b> Type 27 wheels are essentially straight wheels that have a “depressed center/ raised hub”. Different types of fiberglass reinforcement mesh give the product stability for use on the periphery, on the face, or a combination of the two.				
.040", .045", and 1/16" Type 27/42 RightCut	Cutting only, where fast cutting and low kerf loss are desired	◆		
3/32" and .125" Type 27/42	For tough cutting and notching applications where stability is important; cutting and cleaning burr-free narrow root pass welds	◆		
1/8" Type 27	For multiple applications ranging from cutting-off, notching and light-duty side grinding	◆	◆	
1/8" Pipe Notcher Type 27	2-1/2 pieces of reinforcement; durable face grinding; root pass grinding without removing pipe material	◆	◆	
1/8" Type 27 Flexible	For light stock/blending/finishing/polishing		◆	
.140" and 1/8" Type 27 Foundry Notchers	Triple-reinforced for grinding steel and dirty/scale-covered castings; removing and cleaning gates and risers	◆	◆	
1/4" Type 27	For light- to heavy-duty grinding on the bottom/face of the wheel		◆	
1/4" Type 27 Foundry Snaggers	Designed for cleaning parting lines, pads and slag		◆	
1/4" Type 27 Heavy-Duty Foundry	Triple-reinforced for the most aggressive foundry applications		◆	
 <b>TYPE 28</b> Type 28 wheels are constructed with a downward angle built into the grinding section to facilitate a flatter grinding angle. These wheels can only be used on the face and never on the periphery for cutting-off.				
1/4" Type 28 Saucers	Smooth, gouge-free grinding at shallow angles			◆
 <b>TYPE 29</b> Type 29 wheels are constructed with an upward angle built into the grinding section to provide full face contact for light stock removal and blending operations. These wheels can only be used on the face and never on the periphery for cutting-off.				
1/8" Type 29 Flexible, AVOS	Polishing and blending applications			◆

## Material/Application-To-Product Recommendation Guide

	BEST		BETTER	GOOD		
	Quantum3	NorZon Plus	BlueFire	Gemini	Metal	Masonry
<b>CUTTING</b>						
Mild Carbon / High Tensile Steel	◆	◆	◆	◆	◆	
Stainless Steel / Alloys	◆	◆	◆	◆	◆	
Contaminate Free*			◆ FC/INOX/SS	◆ INOX/SS		
Cast Iron	◆	◆		◆		
Gray Iron						
Aluminum / Bronze / Brass				◆ ALU		
Asphalt / Brick / Concrete						◆
Fiberglass / Plastic						◆
<b>NOTCHING</b>						
Mild Carbon / High Tensile Steel	◆	◆	◆	◆	◆	
Stainless Steel / Alloys	◆	◆	◆	◆ INOX/SS		
Contaminate Free*			◆ FC/INOX/SS	◆ INOX/SS		
Cast Iron	◆	◆	◆ Foundry	◆		
<b>GRINDING</b>						
Mild Carbon / High Tensile Steel	◆	◆	◆	◆		
Stainless Steel / Alloys	◆		◆	◆		
Contaminate Free*	◆		◆ FC/INOX/SS	◆ INOX/SS		
Cast Iron		◆	◆ Foundry	◆		
Gray Iron	◆		◆ Foundry	◆		
Aluminum / Bronze / Brass				◆ ALU		
Asphalt / Brick / Concrete						◆
<b>BLENDING</b>						
Mild Carbon / High Tensile Steel				◆ Flexible		
Stainless Steel / Alloys				◆ Flexible		
Aluminum / Bronze / Brass				◆ Flexible		
Fiberglass / Plastic				◆		

Typical Steel, Stainless Steel, Cast Iron Products: Angle Iron, Bar Stock, Ductile Pipe, Channel Iron, Decking, Rebar, I-Beams, Rail Steel, Studs, Tubing, and Welds  
 \* For use in nuclear and food industry applications that require contaminant free (<0.1% iron, sulfur or chlorine)

## Cross Reference Guides

Type 27 and 28 – 1/8" and 1/4"

NORTON	TOTAL PERFORMANCE						INITIAL PRICE				SPECIALTY		
	BEST		BETTER		GOOD		BETTER		GOOD				
	Quantum3	NorZon Plus LL	NorZon Plus	BlueFire	BlueFire FC/INOX/SS	Gemini XXL	Gemini	Gemini Fast Cut	Gemini SS	Metal	BlueFire Foundry	Gemini ALU	Masonry
3M	Cubitron II	-	-	-	-	High Perform., Green Corps	-	-	-	-	-	-	-
Arc	-	-	-	-	-	-	Predator A24R	-	-	-	-	-	-
Brilliant	-	-	-	-	Brill-Max Z24R	-	Brill-Tex A24UHPXL, A30T	Brill-Tex A24R Super-G	Brill-Tex A30P	Hornet Metal	-	Brill-Tex 30ALU	Brill-Tex C30P, Hornet Concrete
Bullard	-	-	TA24S	ZA24R Competitor	ZA24R	-	A24R	A24N	A46Q	A24R Competitor	-	AL36N	C24R
Camel	-	-	-	-	ZA24T	-	A24R	Ultra A24-N-BF, A24T Super Quickie Cut	WA24S	A24N, R&T Fast Cut	-	A30N, Fast Cut	C24R
DeWalt	-	XP Ceramic	-	XP	-	HP	-	-	HP SS	Metal	-	-	-
Flexovit	-	Flexon ZA24P ZA30T	Flexon ZA20Q	Metalhog, AXT24S	-	-	High Perform. A24/30T	High Performance A30S, Specialist A30Q & R	Free Grind A30Q	-	Flexon ZA16U	Specialist A24ALU	High Perform. C24/30P
Metabo	M-Calibur	-	-	ZA24T	-	-	A24R & T	A24N	A360	-	-	A36M	C24N
Pearl	-	-	-	-	Z24T	-	Premium Metal A24S, Redline Max A/WA24S	Premium Metal A24R, Redline Max A/WA24R	WA24R, SRT24	Silver Line A24R & S	-	D.A. Series AL24M	Silver Line C24S
Pferd	SG-Elastic Ceramic C024Q	-	-	ZA SGP, ZA T SGP	ZA R SGP, Z-SG	SG-Elastic	A-PS, A-SG	-	A-SG INOX, A-PS INOX	-	-	A-SG ALU	S-SG, Masonry
Sait	The Ultimate Grind	Saitech Ultimate Perform.	Saitech Attacker, Pipeline	Z24R Z-Tech	Stainless	-	A24R, A24Turbo	A24N	XA24Q	A24T	CA24R - Foundry	A46N-ALU	C24N
Tyrolit	-	-	-	ZA24P-BFX	ZA24N-BFX	-	A30S & Q-BFX	A30R-BFX	A30-BF INOX	A30-BF	ZZA24R-BFX	A36N-BFX WA46-BF	C30-BF
Walter	-	-	-	Allsteel XX	Double-X	Allsteel	HP	-	Stainless	-	-	-	-
Weiler	Tiger Ceramic	-	-	Tiger Zirc	Tiger Inox	Tiger LL	Wolverine A24R	-	-	Wolverine A24N	-	-	-

Type 27 – Flexible 1/8"

GOOD	
<b>NORTON Gemini Flexible</b>	
Brilliant	Brill-Flex
Bullard	Flexlite AC
Camel	FGF, Special Wheel
Flexovit	Flexcel
Metabo	Z-Plus
Pearl	Flexible AC
Pferd	SG-Flex
Sait	Challenger II
Walter	Flexcut





**Best choice for stainless and carbon steel applications; efficiently grinds and cuts a variety of materials from alloys to gray iron**

## QUANTUM3 CERAMIC ALUMINA

- 100% next-generation, uniquely-shaped, ceramic alumina abrasive grain and tough new bond system result in 5-6 times the life of aluminum oxide wheels and up to 100% increase in performance and life over competitive ceramic wheels
- Significantly increase production, for the lowest total grinding cost of any wheel in the market place today
- Better operator control, improved comfort, and exceptional finished part quality with a more robust, sharper, yet smoother cutting action; wheels don't grab or dig



**Best for metal plate, pipe, tubing, cast iron, carbon and mild steel, foundry and welding applications, and ceramics**

## DIALAST DIAMOND WHEELS

- A combination of high-quality diamond and advanced brazed single-layer bonding technology for extra-long life versus conventional abrasives or other vacuum-brazed diamond tools
- Retains diamond grains and wheel shape for full life with low sparks, while keeping a continuous grinding depth for exceptional wheel life; less blade changes reduce downtime and labor costs
- Environmentally friendly design generates minimal dust for less clean-up and safer working conditions



**Better choice for stainless steel, carbon steel, alloys and gray iron**

## BLUEFIRE ZIRCONIA ALUMINA / A/O BLEND

- A blend of the most advanced zirconia alumina and premium aluminum oxide abrasives delivers 2 to 3 times the life of aluminum oxide wheels
- Broad utility; from light-to heavy-pressure applications
- Engineered specifically to deliver fast cut rate; excellent blend of performance and price



**Good choice for steel and ferrous metals as well as specialty applications in aluminum and foundries**

## GEMINI ALUMINUM OXIDE

- Quality aluminum oxide for consistent performance at an economical price
- High-performance bond and wheel hardness are designed for fast cut while retaining excellent wheel life
- Versatile, general purpose specification for use on variety of materials including 400 series stainless, hard carbon steels, soft carbon steels
- Gemini XXL - fastest 100% aluminum oxide wheels on the market today with 50% more life and metal removal than standard aluminum oxide wheels



**Good choice for steel/ferrous metal applications with low initial price**

## METAL ALUMINUM OXIDE

- Durable bond and wheel hardness are designed to provide a good mix of cut rate and life
- Good choice when low initial price is needed for small jobs or newer operators
- Metal (Aluminum Oxide) engineered for all steel/ferrous materials



**Good choice for masonry applications with low initial price**

## MASONRY SILICON CARBIDE

- Durable bond and wheel hardness are designed to provide a good mix of cut rate and life
- Good choice when low initial price is needed for small jobs or newer operators
- Masonry (Silicon Carbide) for masonry materials such as concrete, brick and asphalt



TIER:	<b>BEST</b>	<b>GOOD</b>
TRADENAME:	<b>NORZON PLUS</b>	<b>GEMINI XXL</b>
SHAPE:	Type 27	Type 27
ABRASIVE:	Ceramic Alumina/ Zirconia Alumina	Aluminum Oxide
MATERIAL:	<b>STAINLESS</b> <b>STEEL/METAL</b>	<b>STAINLESS</b> <b>STEEL/METAL</b>

SIZE (D x T x H)	MAX. RPM	STD. PKG.	PART #	PART #
<b>1/8" (5/32") – Pipe Notching – Type 27</b>				
4-1/2 x 1/8 (5/32) x 5/8-11	13,580	10		662533 <b>70272</b> XXL
4-1/2 x 1/8 (5/32) x 7/8	13,580	25		662533 <b>70271</b> XXL
5 x 1/8 (5/32) x 5/8-11	12,225	10		662533 <b>70273</b> XXL
5 x 1/8 (5/32) x 7/8	12,225	25		662528 <b>42038</b> XXL
6 x 1/8 (5/32) x 5/8-11	10,185	10		662528 <b>41193</b> XXL
6 x 1/8 (5/32) x 7/8	10,185	20		662528 <b>35580</b> XXL
7 x 1/8 (5/32) x 5/8-11	8,600	10	662529 <b>39184</b>	662533 <b>70274</b> XXL
7 x 1/8 (5/32) x 7/8	8,600	20		662528 <b>35581</b> XXL
9 x 1/8 (5/32) x 5/8-11	6,600	10	662530 <b>49066</b>	662533 <b>70275</b> XXL
9 x 1/8 (5/32) x 7/8	6,600	20		662533 <b>70276</b> XXL

Pipe Notchers are to be used for cutting/notching only.

See Type 27 .040" – 1/4" Foundry, Type 28 Saucer, Type 27 Flexible, and Type 29 Blending Wheels at the end of this section.



TIER:	<b>BEST</b>	<b>BEST</b>	<b>BETTER</b>	<b>GOOD</b>	<b>GOOD</b>	<b>GOOD</b>
TRADENAME:	<b>QUANTUM3</b>	<b>NORZON PLUS</b>	<b>BLUEFIRE</b>	<b>GEMINI</b>	<b>METAL</b>	<b>MASONRY</b>
SHAPE:	Type 27	Type 27	Type 27	Type 27	Type 27	Type 27
ABRASIVE:	Ceramic Alumina	Ceramic Alumina/ Zirconia Alumina	Zirconia Alumina/ Aluminum Oxide	Aluminum Oxide	Aluminum Oxide	Silicon Carbide
MATERIAL:	<b>STAINLESS</b> <b>STEEL/METAL</b>	<b>STAINLESS</b> <b>STEEL/METAL</b>	<b>STAINLESS</b> <b>STEEL/METAL</b>	<b>STAINLESS</b> <b>STEEL/METAL</b>	<b>STAINLESS</b> <b>STEEL/METAL</b>	<b>MASONRY</b>

SIZE (D x T x H)	MAX. RPM	STD. PKG.	PART #	PART #	PART #	PART #
<b>1/8" – Cutting / Notching / Light Grinding – Type 27</b>						
3 x 1/8 x 3/8	18,000	25	662528 <b>42177</b>			
4 x 1/8 x 3/8	15,280	25	662528 <b>42004</b>	662528 <b>43178</b>	662528 <b>42016</b>	
4 x 1/8 x 5/8	15,280	25	662528 <b>42005</b>	662528 <b>43176</b>	662528 <b>42017</b>	662528 <b>42014</b> 662528 <b>42013</b>
4-1/2 x 1/8 x 5/8-11	13,580	10	662528 <b>39423</b>	662528 <b>43211</b>	662528 <b>43590</b>	662528 <b>43609</b>
	13,580	10		662528 <b>43191</b> FC/INOX/SS	662528 <b>42029</b> ALU 46	
4-1/2 x 1/8 x 7/8	13,580	25	662528 <b>39424</b>	662528 <b>43324</b>	662528 <b>43212</b>	662528 <b>43591</b> 662528 <b>43611</b> 662528 <b>43601</b>
	13,580	25		662528 <b>43190</b> FC/INOX/SS	662528 <b>42030</b> ALU 46	
5 x 1/8 x 5/8-11	12,225	10	662528 <b>39425</b>	662528 <b>43330</b>	662528 <b>43215</b>	662528 <b>43615</b>
	12,225	10		662528 <b>43195</b> FC/INOX/SS		
5 x 1/8 x 7/8	12,225	25	662528 <b>39426</b>	662528 <b>43331</b>	662528 <b>43216</b>	662528 <b>43596</b> 662528 <b>43616</b>
	12,225	25		662528 <b>43194</b> FC/INOX/SS		
6 x 1/8 x 5/8-11	10,185	10	662528 <b>39427</b>	662528 <b>41891</b>	662528 <b>43199</b> FC/INOX/SS	662528 <b>33965</b>
6 x 1/8 x 7/8	10,185	20	662528 <b>39428</b>	662528 <b>43202</b>	662528 <b>43202</b>	662528 <b>01864</b>
	10,185	20		662528 <b>43198</b> FC/INOX/SS		
7 x 1/8 x 5/8-11	8,600	10	662528 <b>39429</b>	662529 <b>38855</b>	662528 <b>43233</b>	662529 <b>39259</b> 07660 <b>702678</b>
	8,600	10		662528 <b>43183</b> FC/INOX/SS		
7 x 1/8 x 7/8	8,600	20	662528 <b>39430</b>	662529 <b>38854</b>	662528 <b>43234</b>	662529 <b>39207</b>
	8,600	25*				07660 <b>775956</b> 5-Pk
9 x 1/8 x 5/8-11	6,600	10	662528 <b>39431</b>	662530 <b>48897</b>	662528 <b>43244</b>	662530 <b>48983</b>
	6,600	10			662528 <b>43187</b> FC/INOX/SS	
9 x 1/8 x 7/8	6,600	20	662528 <b>39432</b>	662530 <b>48896</b>	662528 <b>43245</b>	662530 <b>48994</b>
	6,600	20			662528 <b>43186</b> FC/INOX/SS	

\* 5-wheel Job Packs; wheels are packed 5 wheels/Pack, with 5 Job Packs/carton. Order per each wheel in standard package quantities of 25. Order in multiples of 25.

DEPRESSED CENTER WHEEL DESCRIPTION CODES

BLANK = All Purpose	ALU = Aluminum	FC = Fast Cut	HD = Heavy Duty	INOX/SS = Contaminant Free	LL = Long Life	XXL = Extra Long Life
■ = Aluminum	■ = Foundry	■ = Masonry	■ = Stainless	■ = Steel / Metal		



TIER:	BEST	BEST	BETTER	GOOD	GOOD
TRADENAME:	<b>QUANTUM3</b>	<b>NORZON PLUS</b>	<b>BLUEFIRE</b>	<b>GEMINI / GEMINI XXL</b>	<b>METAL OR MASONRY</b>
SHAPE:	Type 27	Type 27	Type 27	Type 27	Type 27
ABRASIVE:	Ceramic Alumina	Ceramic Alumina/ Zirconia Alumina	Zirconia Alumina/ Aluminum Oxide	Aluminum Oxide	Aluminum Oxide – Metal Silicon Carbide – Masonry
MATERIAL:	<b>STAINLESS</b> <b>STEEL/METAL</b>	<b>STAINLESS</b> <b>STEEL/METAL</b>	<b>STAINLESS</b> <b>STEEL/METAL</b>	<b>STAINLESS</b> <b>STEEL/METAL</b>	<b>STAINLESS</b> <b>STEEL/METAL</b> <b>MASONRY</b>

SIZE (D x T x H)	MAX. RPM	STD. PKG.	PART #	PART #	PART #	PART #	PART #
<b>1/4" – Grinding – Type 27</b>							
3 x 1/4 x 3/8	18,000	25		662528 <b>42178</b>		662528 <b>42179</b>	
4 x 1/4 x 3/8	15,280	25	662533 <b>71180</b>	662528 <b>42002</b>	662528 <b>43179</b>	662528 <b>42018</b>	
4 x 1/4 x 5/8	15,280	25	662533 <b>71181</b>	662528 <b>42003</b>	662528 <b>43177</b>	662528 <b>42020 FC</b>	662528 <b>42011</b>
	15,280	25				662528 <b>42019</b>	662528 <b>42010 Masonry</b>
	15,280	25				662528 <b>42183 ALU 46</b>	
4-1/2 x 3/16 x 7/8	13,580	25		662528 <b>43592</b>		662528 <b>43592</b>	
4-1/2 x 1/4 x 5/8-11	13,580	10	662533 <b>70793</b>	662528 <b>43326</b>	662528 <b>43213</b>	662528 <b>43593</b>	662528 <b>43605</b>
	13,580	10		662528 <b>43327 LL</b>	662528 <b>43193 FC/INOX/SS</b>	662528 <b>43585 FC</b>	662528 <b>43599 Masonry</b>
	13,580	10				662528 <b>42032 INOX/SS</b>	
	13,580	10				662528 <b>43785 XXL</b>	
	13,580	10				662528 <b>42031 ALU 46</b>	
	13,580	40					662528 <b>19559</b>
4-1/2 x 1/4 x 7/8	13,580	10 V		662528 <b>29541 2-Pk</b>	662528 <b>42162 2-Pk</b>	662528 <b>42163 2-Pk</b>	
	13,580	25	662533 <b>70794</b>	662528 <b>43328</b>	662528 <b>43214</b>	662528 <b>43594</b>	662528 <b>43607</b>
	13,580	25			662528 <b>43192 FC/INOX/SS</b>	662528 <b>43584 FC</b>	662528 <b>43600 Masonry</b>
	13,580	25				662528 <b>42033 INOX/SS</b>	
	13,580	25				662528 <b>43784 XXL</b>	
	13,580	25				662528 <b>42034 ALU 46</b>	
	13,580	50					662528 <b>36796</b>
5 x 1/4 x 5/8-11	12,225	10	662533 <b>70795</b>	662528 <b>29540 2-Pk</b>	662528 <b>42164 2-Pk</b>	662528 <b>42165 2-Pk</b>	
	12,225	10		662528 <b>43332</b>	662528 <b>43217</b>	662528 <b>43597</b>	662528 <b>43613</b>
	12,225	10		662528 <b>43333 LL</b>	662528 <b>43197 FC/INOX/SS</b>	662528 <b>43787 XXL</b>	
5 x 1/4 x 7/8	12,225	25	662533 <b>70796</b>	662528 <b>43334</b>	662528 <b>43218</b>	662528 <b>43598</b>	662528 <b>43614</b>
	12,225	25				662528 <b>42040 INOX/SS</b>	
	12,225	25				662528 <b>43786 XXL</b>	
	12,225	25				662528 <b>42039 ALU 46</b>	
6 x 1/4 x 5/8-11	10,185	10	662533 <b>70797</b>	662528 <b>41920</b>	662528 <b>43224</b>	662528 <b>32390</b>	
	10,185	10				662528 <b>43789 XXL</b>	
6 x 1/4 x 7/8	10,185	20	662533 <b>70798</b>	662528 <b>09376</b>	662528 <b>43203</b>	662528 <b>01865</b>	
	10,185	20				662528 <b>43788 XXL</b>	
	10,185	20				662528 <b>43788 XXL</b>	
7 x 1/4 x 5/8-11	8,600	10	662533 <b>70799</b>	662529 <b>17881</b>	662528 <b>43235</b>	662529 <b>40147 FC</b>	662529 <b>12633</b>
	8,600	10		662528 <b>35578 LL</b>	662528 <b>43185 FC/INOX/SS</b>	662529 <b>40148 LL</b>	076607 <b>75942 Masonry</b>
	8,600	10				662528 <b>43791 XXL</b>	
	8,600	10				662529 <b>40514 ALU 24</b>	
	8,600	25*					076607 <b>75940 5-Pk</b>
7 x 1/4 x 7/8	8,600	20	662533 <b>70800</b>	662529 <b>17880</b>	662528 <b>43236</b>	662529 <b>40098 LL</b>	
	8,600	20				662528 <b>43790 XXL</b>	
	8,600	20				662529 <b>40516 ALU 24</b>	
	8,600	25*					076607 <b>75936 5-Pk</b>
9 x 1/4 x 5/8-11	6,600	10	662533 <b>70801</b>	662530 <b>21634</b>	662528 <b>43246</b>	662530 <b>49105 FC</b>	076607 <b>75937 Masonry</b>
	6,600	10		662528 <b>30728 LL</b>		662530 <b>49104 LL</b>	
	6,600	10				662528 <b>43793 XXL</b>	
	6,600	10				662530 <b>49045 ALU 24</b>	
	6,600	25*					076607 <b>75938 5-Pk</b>
9 x 1/4 x 7/8	6,600	20	662533 <b>70802</b>	662530 <b>21633</b>	662528 <b>43247</b>	662530 <b>49077 FC</b>	
	6,600	20		662530 <b>49069</b>	662528 <b>43188 FC/INOX/SS</b>	662530 <b>48991 LL</b>	







\* 5-wheel Job Packs; wheels are packed 5 wheels/Pack. with 5 Job Packs/carton. Order per each wheel in standard package quantities of 25. Order in multiples of 25.  
V Vendible 2-wheel Package. Ideal for vending machings and small jobs. 5 packs/carton. Order in multiples of 10.

See 1/4 inch thick Type 27 Foundry and Type 28 Saucer Wheels on the next page.

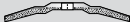
DEPRESSED CENTER WHEEL DESCRIPTION CODES							
BLANK = All Purpose	ALU = Aluminum	FC = Fast Cut	HD = Heavy Duty	INOX/SS = Contaminant Free	LL = Long Life	XXL = Extra Long Life	
■ = Aluminum	■ = Foundry	■ = Masonry	■ = Stainless	■ = Steel / Metal			



TIER:	<b>BEST</b>	<b>BEST</b>	<b>BEST</b>	<b>BEST</b>	<b>BETTER</b>	<b>GOOD</b>
TRADENAME:	<b>QUANTUM3</b>	<b>NORZON PLUS</b>	<b>DIALAST</b>	<b>DIALAST</b>	<b>BLUEFIRE</b>	<b>GEMINI</b>
SHAPE:	Type 28	Type 28	Type 29	Reversible	Type 28	Type 28
ABRASIVE:	Ceramic Alumina	Ceramic Alumina/ Zirconia Alumina	Diamond	Diamond	Zirconia Alumina/ Aluminum Oxide	Aluminum Oxide
MATERIAL:	<b>STAINLESS</b> <b>STEEL/METAL</b>	<b>STAINLESS</b> <b>STEEL/METAL</b>	<b>STAINLESS</b> <b>STEEL/METAL</b>	<b>STAINLESS</b> <b>STEEL/METAL</b>	<b>STAINLESS</b> <b>STEEL/METAL</b>	<b>STAINLESS</b> <b>STEEL/METAL</b>

SIZE (D x T x H)	MAX. RPM	STD. PKG.	PART #	PART #	PART #	PART #	PART #	PART #
<b>1/4" – Grinding – Type 28 Saucer</b> 								
7 x 1/4 x 5/8-11	8,600	10	662533 <b>70803</b>	662529 <b>05369</b>		662528 <b>43229</b>	662529 <b>40149</b>	
7 x 1/4 x 7/8	8,600	20		662529 <b>05368</b>			662529 <b>40095</b>	
9 x 1/4 x 5/8-11	6,600	10	662533 <b>70804</b>	662530 <b>06335</b>		662528 <b>43237</b>	662530 <b>49106</b>	
9 x 1/4 x 7/8	6,600	20	662533 <b>70805</b>				662530 <b>49081</b>	
<b>Light Grinding – Type 29</b> 								
4-1/2 x 5/8-11	13,600	1			662533 <b>70009</b>			
5 x 5/8-11	12,225	1			662533 <b>70010</b>			
6 x 5/8-11	10,200	1			662533 <b>70011</b>			
7 x 5/8-11	8,600	1			662533 <b>70012</b>			
<b>1/4" – Grinding – Reversible Grinding Disc</b> 								
4-1/2 x 1/4 x 5/8-11	13,600	1				662533 <b>70019</b>		
7 x 1/4 x 5/8-11	8,600	1				662533 <b>70020</b>		

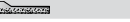

TIER:	<b>BEST</b>	<b>BEST</b>	<b>BEST</b>	<b>BETTER</b>
TRADENAME:	<b>QUANTUM3</b>	<b>NORZON PLUS</b>	<b>DIALAST</b>	<b>BLUEFIRE</b>
SHAPE:	Type 27	Type 27	Type 27	Type 27
ABRASIVE:	Ceramic Alumina	Ceramic Alumina/ Zirconia Alumina	Diamond	Zirconia Alumina/ Silicon Carbide
MATERIAL:	<b>FOUNDRY</b>	<b>FOUNDRY</b>	<b>FOUNDRY</b>	<b>FOUNDRY</b>

SIZE (D x T x H)	MAX. RPM	STD. PKG.	PART #	PART #	PART #	PART #
<b>.140", 1/8" – Cutting / Notching / Lt. Grinding – Type 27</b> 						
4-1/2 x 1/8 x 5/8-11	13,580	10				662528 <b>43206</b>
4-1/2 x 1/8 x 7/8	13,580	25				662528 <b>43204</b>
7 x .140 x 5/8-11	8,600	1			662533 <b>70014</b>	
7 x 1/8 x 5/8-11	8,600	10				662528 <b>43232</b>
7 x 1/8 x 7/8	8,600	20				662529 <b>15526</b>
9 x .140 x 5/8-11	6,600	1			662533 <b>70015</b>	
9 x 1/8 x 5/8-11	6,600	10				662528 <b>43240</b>
9 x 1/8 x 7/8	6,600	20				662528 <b>43238</b>
<b>1/4" – Grinding – Type 27</b> 						
4 x 1/4 x 3/8	15,280	25				662528 <b>43181</b>
4 x 1/4 x 5/8	15,280	25				662528 <b>43180</b>
4-1/2 x 1/4 x 5/8-11	13,580	10				662528 <b>43207</b>
4-1/2 x 1/4 x 7/8	13,580	25				662528 <b>43205</b>
7 x 1/4 x 5/8-11	8,600	10				662528 <b>43231</b>
7 x 1/4 x 7/8	8,600	20				662528 <b>43230</b>
9 x 1/4 x 5/8-11	6,600	10	662533 <b>70849 HD</b>	662530 <b>07014</b>		662528 <b>43241</b>
	6,600	10				662528 <b>43261 HD</b>
9 x 1/4 x 7/8	6,600	20	662533 <b>70848 HD</b>	662530 <b>07013</b>		662528 <b>43239</b>
	6,600	20				662528 <b>43260 HD</b>

All Norton foundry wheels are designed and reinforced to withstand the most aggressive foundry applications.

DEPRESSED CENTER WHEEL DESCRIPTION CODES

BLANK = All Purpose	ALU = Aluminum	FC = Fast Cut	HD = Heavy Duty	INOX/SS = Contaminant Free	LL = Long Life	XXL = Extra Long Life
■ = Aluminum	■ = Foundry	■ = Masonry	■ = Stainless	■ = Steel / Metal		



TIER:	<b>GOOD</b>	<b>GOOD</b>
TRADENAME:	<b>GEMINI FLEXIBLE</b>	<b>GEMINI</b>
SHAPE:	Type 27	Type 29
ABRASIVE:	Aluminum Oxide	Aluminum Oxide
MATERIAL:	<b>ALUMINUM</b>	<b>ALUMINUM</b>
	<b>STEEL/METAL</b>	<b>STEEL/METAL</b>

SIZE (D x T x H)	MAX. RPM	STD. PKG.	GRIT	PART #	PART #
<b>1/8", 1/4" – Blending – Type 27 and 29</b>					
2 x 1/8 x 3/8	30,560	25	60	662528 <b>35632*</b>	
	30,560	25	80	662528 <b>35633*</b>	
4 x 1/8 x 5/8	15,280	20	36	662435 <b>29721#</b>	
	15,280	20	60	662435 <b>29722#</b>	
4-1/2 x 1/8 x 5/8-11	12,000	10	36		662528 <b>42203</b>
4-1/2 x 1/8 x 7/8	12,000	25	36	662528 <b>30424#</b>	662528 <b>42204</b>
	12,000	25	60	662528 <b>30425#</b>	
5 x 1/8 x 7/8	12,225	25	36		662528 <b>42205</b>
7 x 1/8 x 5/8-11	8,600	10	36	662529 <b>39024</b>	662529 <b>17052</b>
7 x 1/8 x 7/8	8,600	20	36	662529 <b>39028#</b>	662529 <b>17051</b>

\*5 wheels per display pack; 5 display packs per standard package.

# These wheels are packed 20 per box, and must be used with this specific back plate. Two back plates are included in each box.



### Depressed Center Adapter Kit

This reusable adapter kit contains everything you need to mount depressed center wheels and saucers with 7/8" center holes on to portable right angle or vertical shaft grinders. Adapter hubs are threaded for mounting on to standard 5/8"-11 NCRH spindles.

KIT NO.	WHEEL DIAMETER	WHEEL THICKNESS	PART #	STD. PKG.
114	6" thru 9"	1/16" thru 1/4"	076607 <b>89275</b>	1

#### DEPRESSED CENTER WHEEL DESCRIPTION CODES

BLANK = All Purpose    ALU = Aluminum    FC = Fast Cut    HD = Heavy Duty    INOX/SS = Contaminant Free    LL = Long Life    XXL = Extra Long Life  
 ■ = Aluminum    ■ = Foundry    ■ = Masonry    ■ = Stainless    ■ = Steel / Metal

no short cuts taken here  
**SATISFY ALL YOUR  
CUT-OFF REQUIREMENTS**

From small diameter portable cut-off wheels to large diameter foundry cut-off wheels; from portable high-speed gas saw wheels to precision toolroom and Metlab wheels, our Norton offering encompasses the broadest range of applications.





# Small Diameter Reinforced Cut-off



The Norton small diameter cut-off wheel line consists of Type 01/41 straight and Type 27/42 depressed center cut-off wheels from 1-1/2" to 9" diameters. These wheels come in ultra thin .035" for quick burn-free and burr-free cutting to .125" for more durable applications. All are reinforced for the demanding nature of portable cut-off.

- Applications:** Cutting sheet metal, cutting pipe, and metal fabrication
- Size Range:** 1-1/2" - 9" diameter
- Thickness Range:** .035", .040", .045", .050", .060", 1/16", .090", 3/32" and .125"
- Abrasive Grain:** Ceramic Alumina / Zirconia Alumina, Zirconia Alumina / Aluminum Oxide, Aluminum Oxide, Silicon Carbide, Diamond
- Shape:** Type 01/41 Straight and Type 27/42 Depressed Center
- Machine Used:**

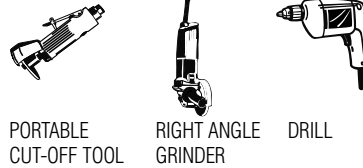

PORTABLE CUT-OFF TOOL      RIGHT ANGLE GRINDER      DRILL

## How to Pick the Right Wheel Type

CUT-OFF WHEEL DESCRIPTION CODES					
BLANK = All Purpose	ALU = Aluminum	FC = Fast Cut	INOX/SS = Contaminant Free	LL = Long Life	1-2-3 = Cutting/Notching/Grinding
■ = Masonry	■ = Stainless	■ = Steel / Metal			

DESCRIPTION CODE DEFINITIONS	
BLANK = All Purpose	Where an excellent blend of cut rate and life is needed
ALU = Aluminum	Specially formulated bond for reduced loading and surface contamination while cutting aluminum and soft materials
FC = Fast Cut	Where fast stock removal is needed, or the application only allows for low-pressure or under-horsepowered grinders
INOX/SS = Contaminate Free	Contain <0.1% iron, sulfur or chlorine for rust-free and corrosion-free results. Will not contaminate stainless steel
LL = Long Life	Where durability is needed due to severe application, and when horsepower of the grinder allows for heavy pressure
<b>RightCut</b> = Cutting-off Only	RightCut wheels for cutting only, provide noticeably longer life and faster cut rate versus competitive wheels, and less pressure is required for first cut
1-2-3 = Cutting/Notching/Grinding	Can be used in cutting, notching and grinding applications

## Type-to-Application Recommendation Guide

Wheel Type/Thickness	Applications	
<b>TYPE 01/41</b> 	Type 01/41 straight cut-off wheels are designed for portable cut-off tool applications. All are supplied with full fiberglass reinforcing.	
.035, .040, .060, and 1/16 .125	Where fast cutting and low kerf loss are desired For tough cutting and notching applications where stability is important	◆ ◆
<b>TYPE 01/41 RIGHTCUT</b> 	Type 01/41 RightCut straight cut-off wheels are designed for use on right angle grinder cut-off applications. All are supplied with full fiberglass reinforcing.	
.035, .040, .045, .050, 1/16 3/32	Where fast cutting and low kerf loss are desired For tough cutting and notching applications where stability is important	◆ ◆
<b>TYPE 27/42 RIGHTCUT</b> 	Type 27/42 RightCut depressed center cut-off wheels are designed for use on right angle grinder cut-off applications. Their depressed center shape provides a recess for the hub, which allows flush cutting. All are supplied with full fiberglass reinforcing.	
.040, .045, 1/16 3/32, .125	Where fast cutting and low kerf loss are desired For tough cutting and notching applications where stability is important	◆ ◆

# Small Diameter Reinforced Cut-off

## Material-To-Product Recommendation Guide

	BEST		BETTER	GOOD		
	Quantum3	NorZon Plus	BlueFire	Gemini	Metal	Masonry
Mild Carbon / High Tensile Steel	◆	◆	◆		◆	
Stainless Steel / Alloys	◆	◆	◆	◆		
Contaminate Free*				◆ INOX/SS		
Cast Iron	◆	◆	◆	◆		
Aluminum / Bronze / Brass				◆ ALU		
Asphalt / Brick / Concrete						◆

\* For use in nuclear and food industry applications that require contaminant free (<0.1% iron, sulfur or chlorine)

## Cross Reference Guides

Type 01/41 .035" - .125" Reinforced Cut-off Wheels for Portable Cut-off Tools



NORTON	TOTAL PERFORMANCE			INITIAL PRICE	
	BEST	BETTER	GOOD		
	NorZon Plus	BlueFire	Gemini Free Cut	Gemini Long Life	Metal
Brilliant	—	Brill-Max ZA	—	—	Safe-Tex FC, LL
Bullard	—	ZA46T, ZA60T	TA36T	TA46T, TA60T	A36T, A60T Comp.
Camel	—	ZA60-TBF	A36 RBF	A60 RBF	Fast Cut RBF
Flexovit	Flexon Fast Cut A46, 60	—	High Perf Fast Grind A36	High Perf Fast Cut A36, 46, 60	—
Pearl	—	SRT, Zirconia	—	Premium	Silver Line
Pferd	—	—	—	—	PSF-A
Sait	Saittech	—	A60S	A24R, A36T, A60T	—
Spedecut	—	—	—	—	A46, 60 TBXX
Walter	—	—	A24 ZIP	A60 ZIP	—

Type 01/41 and Type 27/42 .035" - .125" Reinforced Cut-off Wheels for Right Angle Grinders



90° angle

NORTON	TOTAL PERFORMANCE			INITIAL PRICE		SPECIALTY		
	BEST	BETTER	GOOD	GOOD	GOOD			
	Quantum3 .045"	Quantum3 1/16"	BlueFire	Gemini Free Cut	Gemini	Metal	Gemini ALU	Gemini INOX/SS
3M	—	Cubitron II .045	—	—	—	—	—	—
Brilliant	—	—	—	Brill-Blade Extra FC	Brill-Blade Heavy Duty	Hornet Stinger	—	—
Bullard	—	—	ZA60T	SGA60U	TA46T, TA60T, TA60U	A46T, A60T Comp.	AL46N	—
Camel	—	—	ZA Quickie Cut	A36-S-BF	Super Quickie Cut	Quickie Cut	A46 Quickie Cut	A60-T-BF, WA60R, Quickie Cut
DeWalt	XP Ceramic 0.040	XP Ceramic 1/16", XP Ceramic 0.045	XP	—	HP	Metal	—	—
Flexovit	—	—	—	Razorblade A60SST	Razorblade A24T, 30V, 36T	—	Razorblade A30Q	—
Metabo	Slicer Limited Edition .040	M-Calibur 1/16	Super Slicer	—	Slicer-Plus, Original Slicer LL	Original Slicer	—	—
Pearl	—	—	Redline Max Slimcut	—	Slimcut	Slimcut Pro-V, Silverline	—	—
Pferd	SG Elastic, SG Plus 1mm	SG Plus 1.6, SG Elastic 1.6	—	—	—	PS-Forte	SG-ALU	—
Sait	—	The Ultimate Ceramic Cutoff .045, Saitech	Z-tech	SAIT.M.X	Sait .045, The Ultimate Cutoff	—	A46N	XA46R
SpedeCut	—	—	—	—	—	A46, 60 TBXX	—	—
Walter	Zip One	—	Zip+ Xtra	A-30-ZIP	A-60-ZIP	—	A-60-ZIP-ALU	A60-SS-ZIP
Weiler	Tiger Zirc Ultra Cut 1mm, Tiger INOX UltraCut 1mm	Tiger Ceramic .045, Tiger Zirc .045, Tiger INOX .045	—	—	Tiger	Wolverine	—	—

# Small Diameter Reinforced Cut-off

## SAFETY

### Dangerous Pairing: Die Grinders and Cut-off Wheels

While die grinders and cut-off tools may look similar, they are not interchangeable. Small diameter cut-off wheels can be used only on portable cut-off tools. Several crucial differences exist between the two handheld machines.

- Small diameter cut-off wheels must be used on portable cut-off tools with guards for the safety of the operator and bystanders. Also, portable cut-off tool guards prevent use of an oversize wheel.
- These cut-off wheels must be mounted between proper flanges on portable cut-off tools as described in the national safety standard for abrasive wheels, ANSI B7.1. Die grinders make use of a collet for mounting.
- All cut-off wheels must be used at or below their maximum operating speed, marked clearly on the side of the wheel. Die grinders operate above cut-off wheel speeds. Excessive speed can result in breakage and serious personal injury.



It is the user's responsibility to refer to and comply with ANSI B7.1

## TECH TIP

### Measure Your Wheel's Thickness

Why should you measure your wheel thickness? Many competitors market their wheels as .045", but they are truly thicker. New Norton Quantum3 RightCut wheels are true to size so you can pick the right wheel for the job whether you need precision cutting or rugged durability. Compare our 1/16" Quantum3 with competitive 0.045" ceramic cut-off wheels and you will see the longest life and fastest cut on the market.



It is the user's responsibility to refer to and comply with ANSI B7.1

## Norton Quantum3 RightCut Wheels

The Norton Quantum3 RightCut is our top tier cut-off wheel, available in 0.045" and 1/16" thickness. If you want speed of cut and work on thin or hollow materials, the 0.045" will get you there with comfort. If you are cutting thicker materials and life of the wheel is important, then the 1/16" is ideal. Whatever your pick is, experience the extra-smooth cutting action, thanks to our premium ceramic grain.



### Norton Quantum3 RightCut: 0.045" versus 1/16"

How to match the wheel to the application

**5" x .045" x 7/8"**  
**125 x 1.2 x 22mm**

**5" x 1/16" x 7/8"**  
**125 x 1.6 x 22mm**

PRODUCT	0.045" (FAST CUTTING)	1/16" (LONGEST LIFE)
Abrasive:	Ceramic	Ceramic
Target application:	Thin metals and/or light-style cutting	Thick metals and/or aggressive-style cutting
Strengths:	Fast cutting, smooth easy feel, precise and maneuverable, reduced burrs	Long lasting, durable, aggressive easy feel, versatile across applications and metals

# Small Diameter Reinforced Cut-off



**NEW**

**Best choice for stainless steel and carbon steel applications**

## QUANTUM3 CERAMIC ALUMINA

- 100% advanced ceramic alumina grain with a special shape for comfort and performance guaranteeing 7X the life of aluminum oxide wheels and 3X the life of zirconia alumina wheels
- Unique bond system prevents premature grain release maximizing wheel life
- Available in type 01 straight and type 27 depressed center cut-off wheels from 4-1/2 inch to 6 inch diameters



**Best for metal plate, pipe, tubing, cast iron, carbon and mild steel, foundry and welding applications, and ceramics**

## DIALAST DIAMOND WHEELS

- A combination of high-quality diamond and advanced brazed single-layer bonding technology for extra-long life versus conventional abrasives or other vacuum-brazed diamond tools
- Retains diamond grains and wheel shape for full life with low sparks, while keeping a continuous grinding depth for exceptional wheel life; less blade changes reduces downtime and labor costs
- Environmentally-friendly grinding for minimal dust, less clean-up and safer working conditions



**Best choice for highest productivity for steel, stainless steel and all ferrous metals**

## NORZON PLUS CERAMIC / ZIRCONIA BLEND

- Patented Norton SG ceramic alumina and zirconia alumina grain blend delivers the fastest cutting wheel available on the market, up to 10X faster cutting versus aluminum oxide wheels on 400 series stainless and soft and hard carbon steels
- Ultra-thin side reinforcing creates maximum cut rate and minimum kerf loss; ideal when precise thin cut is desired
- High-performance resin bond adds a freer cut and longest life



**Better choice for stainless steel, carbon steel, alloys and gray iron**

## BLUEFIRE ZIRCONIA ALUMINA / A/O BLEND

- A blend of the most advanced zirconia alumina and premium aluminum oxide abrasives delivers 2 to 3 times the life of aluminum oxide wheels
- Ultra-thin side reinforcing for maximum cut rate with minimum kerf loss; ideal when precise, thin cut is desired
- Broad utility from light-to heavy-pressure applications



**Good, versatile choice for steel and ferrous metals**

## GEMINI ALUMINUM OXIDE

- Quality aluminum oxide for consistent performance at an economical price
- Designed for portable cut-off tool applications where a fast cut and minimum material loss are desired
- Durable bond designed for fast cut while retaining excellent wheel life



**Good choice for grinding alloys, metals, steels, and ferrous metals**

## METAL ALUMINUM OXIDE

- Quality aluminum oxide abrasive for quick cutting action
- Resin bond provides free cutting action with long life
- Good choice when low initial price is needed for small jobs or newer operators

# Small Diameter Reinforced Cut-off

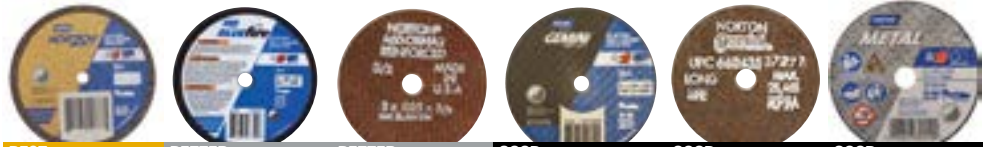

TIER:	BEST	BETTER	BETTER	GOOD	GOOD	GOOD
TRADENAME:	<b>NORZON PLUS</b>	<b>BLUEFIRE</b>	<b>A60-OBNA2</b>	<b>GEMINI</b>	<b>GEMINI LONG LIFE</b>	<b>METAL</b>
SHAPE:	Type 01/41	Type 01/41	Type 01/41	Type 01/41	Type 01/41	Type 01/41
ABRASIVE:	Ceramic Alumina/ Zirconia Alumina	Zirconia Alumina/ Aluminum Oxide	Aluminum Oxide	Aluminum Oxide	Aluminum Oxide	Aluminum Oxide
MATERIAL:	<b>STAINLESS STEEL/METAL</b>	<b>STAINLESS STEEL/METAL</b>	<b>STAINLESS STEEL/METAL</b>	<b>STAINLESS STEEL/METAL</b>	<b>STAINLESS STEEL/METAL</b>	<b>STAINLESS STEEL/METAL</b>

SIZE (D x T x H)	MAX. RPM	STD. PKG.	PART #	PART #	PART #	PART #	PART #	PART #	
<b>.035", .040", .060", 1/16" and .125" Type 01/41 – Cut-off</b>									
1-1/2 x .035 x 1/16	40,745	25			662434 <b>27764</b>				
1-1/2 x .035 x 1/8	40,745	25			662434 <b>27831</b>				
1-1/2 x .035 x 1/4	40,745	25			662434 <b>27875</b>				
2 x .035 x 1/8	30,560	25				662434 <b>11392 FC</b>			
2 x .035 x 1/4	30,560	25			662434 <b>28014</b>	662434 <b>11393 FC</b>			
2 x .035 x 3/8	30,560	25				662434 <b>11394 FC</b>			
2 x .060 x 1/8	30,560	25			662434 <b>28041</b>				
2 x 1/16 x 1/4	30,560	25				662434 <b>11395 FC</b>			
2 x 1/16 x 3/8	30,560	25				662434 <b>11396 FC</b>			
2 x .125 x 1/4	30,560	25				662434 <b>11402 FC</b>			
2 x .125 x 3/8	30,560	25				662434 <b>11403 FC</b>			
2-1/2 x .035 x 1/8	30,560	25			662435 <b>28476</b>				
2-1/2 x .035 x 1/4	30,560	25			662435 <b>28425</b>				
2-1/2 x 1/16 x 1/4	30,560	25				662435 <b>10640 FC</b>			
2-1/2 x 1/16 x 3/8	30,560	25				662435 <b>10641 FC</b>			
3 x .035 x 1/4	25,465	25	662435 <b>10668</b>		662435 <b>28573</b>		662435 <b>10627 FC</b>		
	25,465	25*	662435 <b>31753 5-Pk</b>						
3 x .035 x 3/8	25,465	25	662435 <b>10669</b>	662528 <b>43174</b>	662435 <b>28574</b>	662435 <b>10628 FC</b>	662435 <b>37271 LL</b>	076607 <b>89451</b>	
	25,465	25*		662435 <b>34821 5-Pk</b>					
3 x 1/16 x 1/4	25,465	25	662435 <b>10670</b>		662435 <b>28471</b>	662435 <b>10645 FC</b>	662435 <b>10649 LL</b>		
3 x 1/16 x 3/8	25,465	25	662435 <b>10671</b>	662528 <b>43175</b>	662435 <b>28552</b>	662435 <b>10647 FC</b>	662435 <b>10648 LL</b>	662528 <b>35553</b>	
	25,465	25	662435 <b>10835 LL</b>						
	25,465	25*						076607 <b>47767 5-Pk</b>	
	25,465	100						076607 <b>89012</b>	
	25,465	10-Pk†						662528 <b>43624</b>	
								5 Whls & 1 Mandrel/ Pack	
3 x .125 x 1/4	25,465	25				662435 <b>10650 FC</b>			
3 x .125 x 3/8	25,465	25	662435 <b>10673</b>			662435 <b>10651 FC</b>	662435 <b>10653 LL</b>		
4 x .035 x 1/4	15,300	25			662435 <b>29606</b>				
	19,100	25				662435 <b>10629 FC</b>			
4 x .035 x 3/8	19,100	25	662435 <b>10675</b>	662528 <b>43173</b>	662435 <b>29621</b>	662435 <b>10630 FC</b>	662435 <b>37273 LL</b>	076607 <b>89453</b>	
4 x .035 x 1/2	19,100	25			662435 <b>29622</b>				
4 x .035 x 3/4	19,100	25			662435 <b>29609</b>				
4 x .040 x 3/8	19,100	25			662435 <b>29516</b>				
4 x 1/16 x 1/4	19,100	25	662435 <b>10676</b>			662435 <b>10654 FC</b>			
4 x 1/16 x 3/8	19,100	25	662435 <b>10677</b>	662528 <b>43171</b>		662435 <b>10655 FC</b>		662528 <b>43848</b>	
4 x 1/16 x 5/8	19,100	100			662435 <b>27827</b>				
					FabCut				
4 x .125 x 1/4	19,100	25				662435 <b>10658 FC</b>			
4 x .125 x 3/8	19,100	25	662435 <b>10841</b>	662528 <b>43172</b>		662435 <b>10659 FC</b>	662435 <b>10661 LL</b>		
	19,100	25	662435 <b>10680 LL</b>						

\* 5-wheel Job Packs; wheels are packed 5 wheels/Pack, with 5 Job Packs/carton. Order per each wheel in standard package quantities of 25. Order in multiples of 25.  
 † Order per number of pack, in multiples of 10 packs. Priced per pack.



## Drill-Mount Mandrel

Used for mounting 2" and 3" x 3/8" hole cut-off wheels on to a drill

DESCRIPTION	STD. PKG.	PART #
Drill-Mount Mandrel	1	076607 <b>47769</b>



### CUT-OFF WHEEL DESCRIPTION CODES

BLANK = All Purpose    ALU = Aluminum    FC = Fast Cut    INOX/SS = Contaminant Free    LL = Long Life    1-2-3 = Cutting/Notching/Grinding  
 ■ = Masonry    ■ = Stainless    ■ = Steel / Metal

# Small Diameter Reinforced Cut-off



TIER:	BEST	BEST	BEST	BETTER	GOOD	GOOD
TRADENAME:	<b>QUANTUM3 RIGHTCUT</b>	<b>NORZON PLUS RIGHTCUT</b>	<b>DIALAST RIGHTCUT</b>	<b>BLUEFIRE RIGHTCUT</b>	<b>GEMINI RIGHTCUT</b>	<b>METAL RIGHTCUT</b>
SHAPE:	Type 01/41	Type 01/41	Type 01/41	Type 01/41	Type 01/41	Type 01/41
ABRASIVE:	Ceramic Alumina	Ceramic Alumina/ Zirconia Alumina	Diamond	Zirconia Alumina/ Aluminum Oxide	Aluminum Oxide	Aluminum Oxide
MATERIAL:	<b>STAINLESS</b>	<b>STAINLESS</b>	<b>STAINLESS</b>	<b>STAINLESS</b>	<b>STAINLESS</b>	<b>STAINLESS</b>
	<b>STEEL/METAL</b>	<b>STEEL/METAL</b>	<b>STEEL/METAL</b>	<b>STEEL/METAL</b>	<b>STEEL/METAL</b>	<b>STEEL/METAL</b>

SIZE (D x T x H)	MAX. RPM	STD. PKG.	PART #	PART #	PART #	PART #	PART #	PART #
<b>.035", .040", .045", .050", 1/16, and 3/32" Type 01/41 – RightCut Cut-off</b>								
4 x .040 x 5/8	15,280	25						076607 <b>01616</b>
4 x .045 x 5/8	15,280	25					662435 <b>27956</b>	
4 x 3/32 x 5/8	15,280	25					662435 <b>27955</b>	
4-1/2 x .035 x 7/8	13,580	25						662528 <b>43846</b>
4-1/2 x .040 x 7/8	13,580	25					662528 <b>43225</b>	076607 <b>01617</b>
	13,580	50						662533 <b>70222</b>
	13,580	250+						662528 <b>40001</b>
	13,580	25*						662528 <b>42158 5-Pk</b>
4-1/2 x .045 x 7/8	13,580	25	662528 <b>38454</b>				662528 <b>23602</b>	
	13,580	25					662528 <b>41994 ALU</b>	
	13,580	25					662528 <b>41997 INOX/SS</b>	
	13,580	250+					662528 <b>41213</b>	
	13,580	25*					662528 <b>42160 5-Pk</b>	
4-1/2 x .050 x 7/8	13,580	1			662533 <b>70016</b>			
4-1/2 x 1/16 x 7/8	13,580	25	662528 <b>38455</b>			662528 <b>43208</b>		662528 <b>43845</b>
	13,580	25*				662528 <b>42159 5-Pk</b>		
	13,580	250+				662533 <b>71660</b>		
4-1/2 x 3/32 x 7/8	13,580	25					662528 <b>23599</b>	
5 x .040 x 5/8	12,225	25						662528 <b>43847</b>
5 x .040 x 7/8	12,225	25					662528 <b>43226</b>	076607 <b>01618</b>
5 x .045 x 7/8	12,225	25	662528 <b>38460</b>				662528 <b>23603</b>	
	12,225	25					662528 <b>41995 ALU</b>	
	12,225	250+					662528 <b>41214</b>	
	12,225	25*					662528 <b>42170 5-Pk</b>	
5 x .050 x 7/8	12,225	25		662528 <b>09829 NZ ThinCut</b>				
	12,225	1			662533 <b>70017</b>			
5 x 1/16 x 7/8	12,225	25	662528 <b>38462</b>			662528 <b>43209</b>		
	12,225	25*				662528 <b>42169 5-Pk</b>		
5 x 3/32 x 7/8	12,225	25					662528 <b>23600</b>	
6 x .040 x 7/8	10,185	25						076607 <b>02757</b>
	10,185	50						662533 <b>70223</b>
	10,185	250+						662528 <b>41212</b>
6 x .045 x 7/8	10,185	25					662528 <b>23604</b>	
	10,185	25					662528 <b>41996 ALU</b>	
	10,185	25					662528 <b>41999 INOX/SS</b>	
	10,185	250+					662528 <b>41215</b>	
	10,185	25*				662528 <b>42174 5-Pk</b>	662528 <b>42175 5-Pk</b>	
6 x .050 x 7/8	10,185	1			662533 <b>70018</b>			
6 x 1/16 x 7/8	10,185	25	662528 <b>38465</b>			662528 <b>43210</b>		
	10,185	250+				662533 <b>71662</b>		
6 x 3/32 x 7/8	10,185	25					662528 <b>23601</b>	
7 x .045 x 7/8	8,600	25					662528 <b>32323</b>	
	8,600	20					662528 <b>42000 INOX/SS</b>	
7 x 1/16 x 7/8	8,600	25		662529 <b>00652</b>				
	8,600	1				701846 <b>94055</b>		
9 x .060 x 7/8	6,600	1				701846 <b>94056</b>		

RightCut wheels are to be used for cutting only

\* 5-wheel Job Packs; wheels are packed 5 wheels/Pack, with 5 Job Packs/carton. Order per each wheel in standard package quantities of 25. Order in multiples of 25.

+ Bulk packed 250 Wheels/carton; 5 inner boxes of 50 wheels each. Order in multiples of 250 wheels.

**CUT-OFF WHEEL DESCRIPTION CODES**

BLANK = All Purpose	ALU = Aluminum	FC = Fast Cut	INOX/SS = Contaminant Free	LL = Long Life	1-2-3 = Cutting/Notching/Grinding
■ = Masonry	■ = Stainless	■ = Steel / Metal			

# Small Diameter Reinforced Cut-off



TIER:	BEST	BEST	BETTER	GOOD	GOOD
TRADENAME:	<b>QUANTUM3</b>	<b>NORZON PLUS</b>	<b>BLUEFIRE</b>	<b>GEMINI</b>	<b>METAL</b>
SHAPE:	Type 27/42	Type 27/42	Type 27/42	Type 27/42	Type 27/42
ABRASIVE:	Ceramic Alumina	Ceramic Alumina/ Zirconia Alumina	Zirconia Alumina/ Aluminum Oxide	Aluminum Oxide	Aluminum Oxide
MATERIAL:		<b>STAINLESS STEEL/METAL</b>	<b>STAINLESS STEEL/METAL</b>	<b>STAINLESS STEEL/METAL</b>	<b>STAINLESS STEEL/METAL</b>
				<b>ALUMINUM</b>	

SIZE (D x T x H)	MAX. RPM	STD. PKG.	PART #	PART #	PART #	PART #	PART #
<b>.040, .045, 1/16" – RightCut Cut-off – Type 27/42</b>							
4 x .045 x 5/8	15,280	25				662528 <b>42180</b>	076607 <b>05249</b>
4-1/2 x .040 x 5/8-11	13,580	10				662528 <b>43227</b>	
4-1/2 x .045 x 5/8-11	13,580	10				662528 <b>42025</b>	
	13,580	10				662528 <b>41913</b> INOX/SS	
4-1/2 x .045 x 7/8	13,580	25				662528 <b>42026</b>	662528 <b>43604</b>
	13,580	25				662528 <b>41912</b> INOX/SS	
	13,580	25				662528 <b>41909</b> ALU 36	
	13,580	25*				662528 <b>42161</b> 5-Pk	
	13,580	250				662533 <b>70065</b> 250-Pk	
4-1/2 x 1/16 x 5/8-11	13,580	10	662528 <b>38457</b>		662528 <b>43223</b>		
4-1/2 x 1/16 x 7/8	13,580	10			662528 <b>43219</b>		
	13,580	25	662528 <b>38456</b>				
5 x .040 x 5/8-11	12,225	10				662528 <b>43228</b>	
5 x .045 x 5/8-11	12,225	10				662528 <b>41939</b>	
5 x .045 x 7/8	12,225	25				662528 <b>42036</b>	662528 <b>43849</b>
	12,225	25				662528 <b>41914</b> INOX/SS	
	12,225	25				662528 <b>41910</b> ALU 36	
	12,225	25*				662528 <b>42171</b> 5-Pk	
	12,225	250				662533 <b>70066</b> 250-Pk	
5 x 1/16 x 7/8	12,225	25	662528 <b>38464</b>		662528 <b>43220</b>		
6 x .045 x 5/8-11	10,185	10		662528 <b>42007</b>		662528 <b>30587</b>	
6 x .045 x 7/8	10,185	25				662528 <b>42202</b>	662528 <b>42015</b>
	10,185	25				662528 <b>41916</b> INOX/SS	
	10,185	25				662528 <b>41911</b> ALU 36	
	10,185	25*				662528 <b>42176</b> 5-Pk	
	10,185	250				662533 <b>70067</b> 250-Pk	
6 x 1/16 x 7/8	10,185	25	662528 <b>38466</b>		662528 <b>43221</b>		
7 x .045 x 5/8-11	8,600	10				662528 <b>41919</b> INOX/SS	
7 x .045 x 7/8	8,600	20				662529 <b>12626</b>	
	8,600	20				662528 <b>41918</b> INOX/SS	
7 x 1/16 x 7/8	8,600	10					076607 <b>05251</b>
9 x 1/16 x 5/8-11	6,600	10				662530 <b>19115</b>	
9 x 1/16 x 7/8	6,600	10				662530 <b>17734</b>	
<i>RightCut wheels are to be used for cutting only.</i>							
<b>3/32", .125" – Cut-off – Type 27/42</b>							
4 x .125 x 3/8	15,280	25		662528 <b>42001</b>			
4-1/2 x 3/32 x 5/8-11	13,580	10				662528 <b>41903</b>	
	13,580	10				662528 <b>42027</b> INOX/SS	
4-1/2 x 3/32 x 7/8	13,580	25				662528 <b>41940</b>	
	13,580	25				662528 <b>42028</b> INOX/SS	
	13,580	25				662528 <b>43582</b> 1-2-3	
4-1/2 x .125 x 5/8-11	13,580	10	662528 <b>43321</b>			662528 <b>43588</b>	
4-1/2 x .125 x 7/8	13,580	25	662528 <b>43322</b>			662528 <b>43589</b>	
5 x 3/32 x 5/8-11	12,225	10				662528 <b>41904</b>	
5 x 3/32 x 7/8	12,225	25				662528 <b>42037</b> INOX/SS	
	12,225	25				662528 <b>43587</b> LL	
5 x .125 x 7/8	12,225	25				662528 <b>43595</b>	
6 x 3/32 x 5/8-11	10,185	10				662528 <b>41905</b>	
6 x 3/32 x 7/8	10,185	25				662528 <b>41906</b>	
	10,185	25				662528 <b>32487</b> INOX/SS	
6 x .125 x 5/8-11	10,185	10				662528 <b>41192</b>	
6 x .125 x 7/8	10,185	25				662528 <b>42021</b>	
7 x 3/32 x 5/8-11	8,600	10				662528 <b>41907</b>	
7 x 3/32 x 7/8	8,600	20				662528 <b>41908</b>	
	8,600	20				662529 <b>14638</b> INOX/SS	
7 x .125 x 5/8-11	8,600	10		662529 <b>12625</b>			
7 x .125 x 7/8	8,600	20		662529 <b>12624</b>		662529 <b>00619</b>	
9 x 3/32 x 5/8-11	6,600	10			662528 <b>42378</b>		
9 x 3/32 x 7/8	6,600	20			662528 <b>42343</b>		

*These wheels are to be used for cutting only. \* 5-wheel Job Packs; wheels are packed 5 wheels/Pack, with 5 Job Packs/carton. Order per each wheel in standard package quantities of 25. Order in multiples of 25.*

# Circular Saw Reinforced Cut-off

A circular saw uses an abrasive wheel to cut different materials using a rotary motion spinning around an arbor. Norton Circular Saw abrasive cut-off wheels are ideal for use in deburring, cleaning, slotting and cutting all types of metal and masonry.

**Applications:**

Deburring, cleaning, slotting and cutting

**Size Range:**

6" - 9" diameter

**Thickness Range:**

.035", .060", 1/16", 1/8", and .125"

**Abrasive Grain:**

Zirconia Alumina / Aluminum Oxide, Aluminum Oxide, Silicon Carbide, Diamond

**Shape:**

Type 01/41 Straight

**Machine Used:**



CIRCULAR SAW



TIER:	BEST	BETTER	GOOD	GOOD	GOOD
TRADENAME:	<b>DIALAST</b>	<b>CHARGER</b>	<b>GEMINI</b>	<b>METAL</b>	<b>MASONRY</b>
SHAPE:	Type 01/41	Type 01/41	Type 01/41	Type 01/41	Type 01/41
ABRASIVE:	Diamond	Zirconia Alumina/ Aluminum Oxide	Aluminum Oxide	Aluminum Oxide	Silicon Carbide
MATERIAL:	<b>STAINLESS</b>	<b>STEEL/METAL</b>	<b>STEEL/METAL</b>	<b>STEEL/METAL</b>	<b>MASONRY</b>

SIZE (D x T x H)	MAX. RPM	STD. PKG.	PART #	PART #	PART #	PART #	PART #
<b>Type 01/41 – Circular Saw</b>							
6 x .035 x 5/8	10,185	25		662528	<b>09714</b>		
6 x 1/16 x 5/8	10,185	25		662528	<b>09718</b>		
6-1/2 x .125 x DM-5/8	9,405	10				076607	<b>89098</b>
7 x 1/16 x 5/8	8,730	25		662529	<b>05957</b>		
7 x .060 x 7/8	8,600	1	701846	<b>94055</b>			
7 x 1/8 x DM-5/8	8,730	25				076607	<b>89097</b>
8 x 1/16 x 5/8	7,640	25		662530	<b>17771 LL</b>		
	7,640	10			662530	<b>17795</b>	
8 x 1/8 x DM-5/8	7,640	10				076607	<b>89096</b>
9 x .060 x 7/8	6,600	1	701846	<b>94056</b>			



DM Denotes Diamond Mount; 5/8" hole bushings included

CUT-OFF WHEEL DESCRIPTION CODES				
BLANK = All Purpose	FC = Free Cut	LL = Long Life	■ = Masonry	■ = Stainless
				■ = Steel / Metal



# Chop Saw Reinforced Cut-off



A chop saw is a light, low-horsepower portable machine. Although very similar to a compound miter saw, it is designed for cutting denser materials, like metal bar, tubing or pipe. Chop saw cut-off wheels are designed specifically for this machine with finer grit, softer grades, and reinforcement layers that match the application.

- Applications:** Cutting small-diameter metal pieces, bar stock, metal pipe, tubing, decking, cable, drywall studs, and metal plate dimensioning
- Size Range:** 10" - 16" diameter
- Thickness Range:** 3/32" and 7/64"
- Abrasive Grain:** Zirconia Alumina / Aluminum Oxide Blend, Aluminum Oxide, and Diamond
- Shape:** Type 01/41 Straight
- Reinforcement Type:** Side reinforced, centrally reinforced
- Machine Used:**



## Cross Reference Guide

	TOTAL PERFORMANCE			INITIAL PRICE			SPECIALTY	
	BETTER			GOOD			GOOD	
<b>NORTON</b>	<b>BlueFire Free Cut</b>	<b>BlueFire Rapid Cut</b>	<b>BlueFire Long Life</b>	<b>Gemini Free Cut</b>	<b>Gemini Rapid Cut</b>	<b>Gemini Long Life</b>	<b>Stud Cutter</b>	<b>Gemini Aluminum</b>
Brilliant	—	—	—	Super-G	Tube/Pipe	—	Drywall Stud	Aluminum
Bullard	ZA36T	—	—	TA36T A46T The Competitor	A36R The Competitor	A36R Ironmaster	A46T Studmaster	AL36R
Camel	—	—	ZA24-S	A36-P, WA36-P	—	A36-S	A30-R Mr. Stud	A30-N
Dewalt	—	—	XP	GP, Stainless Fabrication	—	—	Stud Cutting	—
Flexovit	—	—	—	A30R Fast Cut A30-Q Free Cut	—	A30S Long Life	A30T Drywall Stud	—
Makita	—	—	—	—	General Purpose	—	—	—
Pearl	SRT36	—	—	A36P Premium	A30P Silver Line	—	A46S Stud Cutting	—
Pferd	—	—	—	A 36 K SG CHOP	PSF CHOP	—	A 36 K SG-STUD	—
Sait	Saitech Steel Worker	Z-tech	—	EZ-Chop	EZ-Chop Attacker	Iron Worker	Stud King	Aluminum
Walter	—	—	—	—	A-30	A-30-HC+	—	A30-ALU

## Application-to-Product Recommendation Guide

### Wheel Type/Reinforcement

#### TYPE 01/41 STRAIGHT SIDE-REINFORCED CUT-OFF WHEEL

Side-reinforced wheels have two full layers of reinforcing and are designed for a fast cut and the most aggressive applications. All Purpose, Free Cut, and Long Life are side reinforced.



#### TYPE 01/41 STRAIGHT CENTRALLY-REINFORCED CUT-OFF WHEEL

Centrally-reinforced wheels have a single layer of reinforcing with exposed rough sides for free-cutting, non-binding applications where minimal burr and burn are the key requirements. Rapid Cut wheels are centrally reinforced.



## How to Pick the Right Bond Type

### DESCRIPTION CODE DEFINITIONS

<b>BLANK</b> = All Purpose	Where an excellent blend of cut rate and life is needed
<b>FC</b> = Free Cut	Used when fast, burn-free cutting is desired or when cutting pieces with larger cross sections
<b>LL</b> = Long Life	Where durability is needed due to severe application, and when cutting parts with small cross sections
<b>RC</b> = Rapid Cut	Where a free cutting, non-binding wheel is needed for burn-free and burr-free cuts
<b>STUD</b> = High-Performance	High-performance aluminum oxide/resin bond combination designed for cleaner cuts and longer life when cutting steel studs
<b>ALU</b> = Aluminum	Specially formulated bond for reduced loading/surface contamination when cutting aluminum/soft materials

# Chop Saw Reinforced Cut-off



Designed for cutting steel, metal studs, stainless steel, non-ferrous materials, tile, brick, plastic and much more

## DIALAST DIAMOND

- A combination of high-quality diamond and advanced brazed single-layer bonding technology for extra-long life versus conventional abrasives or other vacuum-brazed diamond tools
- Retains diamond grains and wheel shape for full life with low sparks, while keeping a continuous grinding depth for exceptional wheel life; less blade changes reduce downtime and labor costs
- Environmentally-friendly grinding for minimal dust, less clean-up and safer working conditions

Better choice for steel, stainless steel and all other ferrous metals



## BLUEFIRE ZIRCONIA ALUMINA / A/O BLEND

- Durable, latest generation zirconia alumina and premium aluminum oxide abrasive blend outperforms competitive chop saw zirconia wheels by 20 percent
- Delivers twice the life and cut rate of aluminum oxide wheels on difficult to cut metals
- High performance resin bond is designed for free cut and long life

Good choice for all steel and ferrous metals as well as specialty applications in aluminum



## GEMINI ALUMINUM OXIDE

- Durable, versatile aluminum oxide abrasive engineered for consistent performance and economical price on chop saw cut-off machine applications
- Abrasive and bond combination designed for smooth clean cut on low HP machines
- Good choice for consistent performance at an economical price

Good choice for drywall studs



## METAL ALUMINUM OXIDE

- Quality aluminum oxide abrasive designed for cutting alloys, steels and ferrous metals including 400 series stainless, soft and hard carbon steels
- Designed with finer grit and softer grades, specifically for chop saw machines that typically have lower horsepower
- Constructed with full fiberglass reinforcing; Stud Cutter version designed specifically for cutting steel studs

# Chop Saw Reinforced Cut-off



TIER:	BEST	BETTER	BETTER	GOOD	GOOD	GOOD	GOOD
TRADENAME:	<b>DIALAST</b>	<b>BLUEFIRE</b>	<b>BLUEFIRE</b>	<b>GEMINI</b>	<b>GEMINI</b>	<b>METAL</b>	<b>METAL</b>
SHAPE:	Type 01/41	Type 01/41	Type 01/41	Type 01/41	Type 01/41	Type 01/41	Type 01/41
ABRASIVE:	Diamond	Zirconia Alumina/ Aluminum Oxide	Zirconia Alumina/ Aluminum Oxide	Aluminum Oxide	Aluminum Oxide	Aluminum Oxide	Aluminum Oxide
REINFORCING:		Side	Central	Side	Central	Side	Central
MATERIAL:	<b>STAINLESS</b>	<b>STAINLESS</b>	<b>STAINLESS</b>	<b>STAINLESS</b>	<b>STAINLESS</b>	<b>STAINLESS</b>	<b>STAINLESS</b>
		<b>STEEL/METAL</b>	<b>STEEL/METAL</b>	<b>STEEL/METAL</b>	<b>STEEL/METAL</b>	<b>STEEL/METAL</b>	<b>STEEL/METAL</b>

SIZE (D x T x H)	MAX. RPM	STD. PKG.	PART #	PART #	PART #	PART #	PART #	PART #			
<b>Type 01/41 Straight Cut-off</b>											
10 x 7/64 x 1	6,110	10				662531	<b>06109 LL</b>				
12 x 7/64 x 1	5,095	10		662528	<b>43250</b>		662532	<b>07554 LL</b>	662532	<b>14561 RC</b>	
	5,095	5							076607	<b>89400</b>	
14 x 3/32 x 1	4,365	10				662533	<b>06627 FC</b>	662533	<b>13588 RC</b>	662528	<b>35554</b>
	4,365	10				662533	<b>06626 LL</b>		076607	<b>89405</b>	<b>STUD</b>
	4,365	5 V								076607	<b>89399</b>
14 x 7/64 x 1	4,365	10		662528	<b>43252 FC</b>	662528	<b>43254 RC</b>	662533	<b>14816 ALU</b>		
	4,365	10		662528	<b>43253 LL</b>						
	4,365	25								076607	<b>03970 5-Pk</b>
14 x .155 x 1	5,400	1	701846	<b>94053</b>							
16 x 7/64 x 1	3,820	10		662528	<b>43256 FC</b>		662534	<b>10198 LL</b>			
	3,820	10		662528	<b>43257 LL</b>						



V Vendible 2-wheel Package. Ideal for vending machings and small jobs. 5 packs/carton. Order in multiples of 10.

CUT-OFF WHEEL DESCRIPTION CODES						
BLANK = All Purpose	ALU = Aluminum	FC = Free Cut	LL = Long Life	RC = Rapid Cut	STUD = Stud Cutter	
■ = Masonry	■ = Stainless	■ = Steel / Metal				



# High-Speed Reinforced Cut-off



Norton high-speed cut-off abrasive wheels provide the industry's leading performance in all high-speed gas and electric-powered applications.

- Applications:** Metalworking: steel, stainless, ductile, cast iron, rail steel and metal decking  
Non-Metal Building Materials: concrete, brick, masonry, asphalt aggregate, stone and schedule 40 and 80 PVC pipe  
Rescue and Demolition: steel, acrylic, fiberglass, rubber, glass, wood, concrete, brick and asphalt
- Size Range:** 12" – 16" diameter
- Thickness Range:** 1/8" and 5/32"
- Abrasive Grain:** Aluminum Oxide, Silicon Carbide, Silicon Carbide / Aluminum Oxide Blend
- Shape:** Type 01/41 Straight
- Reinforcement:** Wheels are offered in standard two-layer reinforcement as well as three-layer reinforcement for higher-speed saws and heavy-duty applications.
- Arbor:** Wheels are offered with patented universal arbor that accommodates both 20mm and all other machines with 1" arbors.

**Machine Used:**



HIGH-SPEED GAS  
OR ELECTRIC SAW

## Material / Application-to-Product Recommendation Guide

Icon		Application
	Metal	High-performance aluminum oxide grain wheels designed for general purpose cutting of all steel and stainless parts including rebar, steel pipe, structural steel, sheet metal, cable and small to medium diameter solid pieces.
	Metal Decking	High-performance aluminum oxide abrasive combined with a thicker wheel (5/32") that stands up to the sharp edges of sheet metal and roof decking.
	Ductile/Cast Iron	A special blend of silicon carbide abrasive for cutting and aluminum oxide abrasive for life, designed to cut ductile and cast iron pipe, concrete-lined water pipes, sewer construction and heavy duty PVC.
	Rescue	For ventilation, forcible entry, rescue and demolition. A versatile abrasive formula that can be used on a wide range of materials including all types of metals and masonry.
	Concrete	Coarse grit silicon carbide abrasive provides a low initial cost solution for cutting brick, block, concrete or other masonry materials. For higher-production applications that require optimum speed of cut and product life, please see our complete selection of high-speed diamond wheels in our Norton Construction diamond product line.
	Asphalt	A special blend of extra coarse silicon carbide abrasive grains provides a low initial cost solution for cutting asphalt, green concrete, asphalt over concrete, a wide range of aggregates and abrasive materials. For higher-production applications that require optimum speed of cut and product life, please see our Norton Construction diamond blade product offering in the Construction Product section of this catalog -and the complete offering in our "Diamond, Abrasives and Equipment for the Construction Market Catalog" #7719 found on <a href="http://www.nortonabrasives.com">www.nortonabrasives.com</a>

## Cross Reference Guide

SPECIALTY

NORTON	GOOD				
	Gemini Metal	Gemini Metal Decking	Gemini Ductile	Gemini Concrete	Gemini Asphalt
Abmast	A 24 R, Kompetitor Metal	A 24 T	AC 24 R, Kompetitor Ductile Iron	C 24 R, Kompetitor Concrete	C 16 T, Kompetitor Asphalt
Brilliant	Metal/Stainless	—	—	Concrete/Masonry	—
Bullard Blaze & Road Warrior	A24R, ZA24Q, The Competitor	TA24R	AC24R	C24R, The Competitor	CC20R
Camel	A24-R	A24-T	AC24-R	C24-R	C16-U
Flexovit	A24/30SB	A24TB	AC24SB	C30UB	C16UB
Husqvarna	Blue XHS, Blue QMS-CM, Blue EHS	Grey QMS-CM	Green QMS-CM, Green EHS	Red XHS, Red QHS-CM, Red EHS	Black QMS-AS
Pearl	SRT, Premium A36S, Silver Line A30R	—	AC30S	Premium C36S, Silver Line C24R	—
Pferd	A 24 R SG	A 24 Q SG-RAIL	AC 24 Q SG	C 24 R SG	—
Sait	A24R, A30S, XFC	Brute	Ductile	C24R	Big M.A.C, XFC
Tyrolit	A30P, A30BF	—	AC24, AC30BF	1C24, C30BF	—
Virginia Abrasives	Metal	—	Ductile	Concrete	Asphalt
Walter	A-24	—	—	—	—

# High-Speed Reinforced Cut-off

## How to Pick the Right Reinforcement

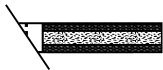

Two full layers of reinforcing are offered for lower power machines, and light-to-medium applications where speed of cut is the primary selection criterion.

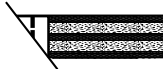

Three full layers of reinforcing are recommended for high-speed, high-power machines where the application is heavy-duty, and durability is the primary selection criterion.



TIER:	<b>GOOD</b>	<b>GOOD</b>	<b>GOOD</b>	<b>GOOD</b>
TRADENAME:	<b>GEMINI METAL HD</b>	<b>GEMINI METAL</b>	<b>GEMINI METAL DECKING</b>	<b>GEMINI RESCUE</b>
SHAPE:	Type 01/41	Type 01/41	Type 01/41	Type 01/41
ABRASIVE:	Aluminum Oxide	Aluminum Oxide	Aluminum Oxide	Silicon Carbide/ Aluminum Oxide Blend
REINFORCING:	3 Layers	2 Layers	2 Layers	2 Layers
MATERIAL:				

SIZE (D x T x H)	MAX. RPM	STD. PKG.	PART #	PART #	PART #	PART #
<b>Type 01/41 Cut-off – for Gas &amp; Electric-Powered Saws</b>						
12 x 1/8 x 1" / 20mm	6,300	10	662528 <b>36708</b>	662528 <b>37838</b>		
14 x 1/8 x 1" / 20mm	5,400	10	662528 <b>35386</b>	662528 <b>37841</b>		662435 <b>78262</b>
14 x 5/32 x 1" / 20mm	5,400	10			662528 <b>32521</b>	
16 x 1/8 x 1" / 20mm	4,800	10		662528 <b>30886</b>		

See additional Rail Cut wheels on the next page for larger-volume jobs.



TIER:	<b>GOOD</b>	<b>GOOD</b>	<b>GOOD</b>	<b>GOOD</b>	<b>GOOD</b>
TRADENAME:	<b>GEMINI DUCTILE HD</b>	<b>GEMINI DUCTILE</b>	<b>GEMINI CONCRETE HD</b>	<b>GEMINI CONCRETE</b>	<b>GEMINI ASPHALT</b>
SHAPE:	Type 01/41	Type 01/41	Type 01/41	Type 01/41	Type 01/41
ABRASIVE:	Silicon Carbide / Aluminum Oxide Blend	Silicon Carbide / Aluminum Oxide Blend	Silicon Carbide	Silicon Carbide	Silicon Carbide
REINFORCING:	3 Layers	2 Layers	3 Layers	2 Layers	2 Layers
MATERIAL:					

SIZE (D x T x H)	MAX. RPM	STD. PKG.	PART #	PART #	PART #	PART #	PART #
<b>Type 01/41 Cut-off – for Gas &amp; Electric-Powered Saws</b>							
12 x 1/8 x 1" / 20mm	6,300	10		662528 <b>37840</b>		662528 <b>37839</b>	701846 <b>70243</b>
14 x 1/8 x 1" / 20mm	5,400	10	662528 <b>35388</b>	662528 <b>37843</b>	662528 <b>35387</b>	662528 <b>37842</b>	701846 <b>72877</b>
16 x 1/8 x 1" / 20mm	4,800	10				701846 <b>23029</b>	



## Universal Arbor

### Two Blade Sizes in One

Our Norton patented 1"/20mm knock-out arbor fits all gas and electric high-speed saws. A 20mm bushing is pre-mounted into the 1" molded arbor hole. The wheel, with the 20mm bushing, can be mounted directly on any 20mm arbor high-speed saw. With the bushing removed, exposing the 1" arbor hole, the wheel can be mounted on any 1" arbor high-speed saw. Combining this arbor, with heavy-duty triple reinforcing results in a higher performing, extra strong, longer lasting cutting wheel. Once the 20mm bushing is removed, it cannot be replaced.

# Walk-Behind Reinforced Cut-off



These powerful, self-propelled machines are designed to cut concrete slabs and asphalt and are normally fitted with diamond blades. For inexperienced operators or small jobs, the machines can accommodate these low initial cost, conventional abrasives wheels.

- Applications:** Cutting straight sections of concrete surfaces
- Size Range:** 14" and 18" diameter
- Thickness Range:** 3/16" – 3/8"
- Abrasive Grain:** Silicon Carbide
- Bond:** Hot Pressed (HP) – for higher-horsepower machine applications where additional durability is needed, may be used wet or dry  
Cold Pressed (CP) – for lower-horsepower machines, which need a free-cutting wheel
- Shape:** Type 01/41 Straight
- Arbor:** All are 1" with a drive pin
- Machine Used:**



FLAT SAW /  
WALK-BEHIND SAW

## Cross Reference Guide

NORTON	SPECIALTY		
	BETTER	GOOD	GOOD
	<b>Gemini Asphalt / Green Concrete – HP</b>	<b>Gemini Asphalt - CP</b>	<b>Gemini Concrete - CP</b>
Abmast	—	C 16 T. Kompetitor Asphalt/Concrete	C 24 R
Bullard Blaze & Road Warrior	—	C16R & T, C16R3	—
Camel	—	C16-U	C24-R
Flexovit	HPC16AG	C16 G.P. C16UB	C20SB/C16TB
Husqvarna	Red GC-7A	Black EWC	Gold RTC, Blue RTC, Blue EWC
Pearl	—	—	Premium C36S, Silver Line C24R
Pferd	—	C 24 R SG ASP	C 24 R SG GP
Sait	Street Runner	C16	C24R, Street Walker
Tyrolit	Concrete/Asphalt CHP	Asphalt CP	Concrete CP
Virginia Abrasives	—	GC/Asphalt	Concrete
Walter	—	—	C-24



TIER:	BETTER	GOOD	GOOD
TRADENAME:	<b>GEMINI ASPHALT - HP</b>	<b>GEMINI ASPHALT - CP</b>	<b>GEMINI CONCRETE - CP</b>
SHAPE:	Type 01/41	Type 01/41	Type 01/41
ABRASIVE:	Silicon Carbide	Silicon Carbide	Silicon Carbide
BOND:	Hot Pressed - Long Life	Cold Pressed - Free Cut	Cold Pressed - Free Cut

MATERIAL:

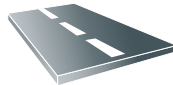

SIZE (D x T x H)	MAX. RPM	STD. PKG.	PART #	PART #	PART #
<b>Type 01/41 Cut-off – For Walk-Behind Saws</b>					
14 x 3/16 x 1 Pin Hole	4,365	10		701846 <b>80324</b>	701846 <b>80323</b>
14 x 1/4 x 1 Pin Hole	4,365	5			701846 <b>70533</b>
18 x 1/4 x 1 Pin Hole	4,250	5	701846 <b>70103</b>		

For higher-production applications, optimum speed of cut and product life, please see our diamond blade product offering for walk-behind saws in the Construction Product section of this catalog and the complete offering in our Diamond, Abrasives and Equipment for the Construction Market Catalog #7719 found on [www.nortonabrasives.com](http://www.nortonabrasives.com).

# Stationary Saw Reinforced Cut-off



The Norton stationary saw reinforced cut-off wheel line consists of Type 01/41 straight 10" - 24" wheels, designed to fit on fixed-base stationary saws that are free-standing or mounted on a workbench.

- Applications:** Primary applications are cutting of all metal parts (flat stock, bars, studs, pipes, tubes, angle iron, cable), wire rope and hydraulic hose used in fabrication, construction and plant maintenance.
- Size Range:** 10" - 20" diameter
- Thickness Range:** 3/32", 1/8", 5/32", 3/16"
- Abrasive Grain:** Zirconia Alumina / Aluminium Oxide Blend, Aluminum Oxide, Silicon Carbide
- Shape:** Type 01/41 Straight
- Machine Used:**



STATIONARY SAW

## Cross Reference Guide

NORTON	TOTAL PERFORMANCE				INITIAL PRICE	SPECIALITY
	BETTER	GOOD	GOOD	GOOD		
	<b>BlueFire</b>	<b>Gemini Free Cut</b>	<b>Gemini Long Life</b>	<b>Gemini Rapid Cut*</b>	<b>Norton Masonry</b>	<b>Foundry Cut**</b>
Abmast	Z 24 R3	A 30 R	—	—	—	AC 24 R3
Brilliant	—	GP Fast Cut	GPX Long Life	XL , XLX	—	—
Bullard	—	A30-R	A30-T	A300	C20R	—
Camel	ZA24-R	A24-R, A46-T	—	—	C24-R	WA24-S
Flexovit	—	A30RB Multi Purpose	A30SB Long Life, A24TB Long Life	—	C24RB	AC24PB Heavy Duty
Metabo	—	A30N, A30R	A30S, A30V	—	C30S	—
Pearl	SRT36	A30P Premium, A30Q Silver Line	A30S Premium, A36R Premium	—	C24 Silver Line	—
Pferd	ZA 24 Q/R SG-HD	A 24 N/P SG-HD	A 24 Q/S SG-HD	—	C 24 0 SG	—
Sait	—	A24N, A36R	A24R	—	C24R	—
Tyrolit	—	A30BF	—	—	C30BF	—
Walter	—	A-24-FC	A-24-RIP	—	—	—

\* For Burr-Free applications, please see centrally-reinforced BlueFire Rapid Cut and Gemini Rapid Cut wheels in Chop Saw cut-off wheel section or at [www.nortonabrasives.com](http://www.nortonabrasives.com)

\*\* For Foundry and other cut-off wheels, please refer to that section of this Norton Full Line Catalog #7362 or at [www.nortonabrasives.com](http://www.nortonabrasives.com)

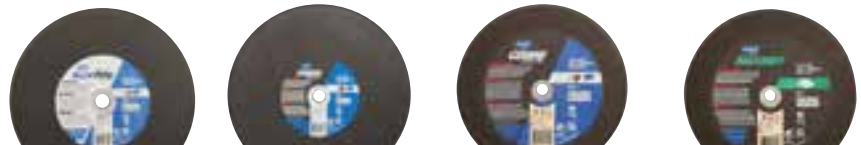

SIZE (D x T x H)	MAX. RPM	STD. PKG.	TIER: BETTER	GOOD	GOOD	GOOD
			TRADENAME: BLUEFIRE	GEMINI FREE CUT	GEMINI LONG LIFE	MASONRY
			SHAPE: Type 01/41	Type 01/41	Type 01/41	Type 01/41
			ABRASIVE: Zirconia Alumina/Aluminum Oxide	Aluminum Oxide	Aluminum Oxide	Silicon Carbide
			MATERIAL: STAINLESS	STAINLESS	STAINLESS	MASONRY
			STEEL/METAL	STEEL/METAL	STEEL/METAL	
SIZE (D x T x H)	MAX. RPM	STD. PKG.	PART #	PART #	PART #	PART #
<b>Type 01/41 Straight Cut-Off</b>						
10 x 3/32 x 5/8	6,110	10	662528 <b>43248</b>	662531 <b>06101 FC</b>	662531 <b>06102 LL</b>	
	6,110	5				076607 <b>89391</b>
12 x 1/8 x 1	5,095	10	662528 <b>43249</b>		662532 <b>07548 LL</b>	
	5,095	5				
14 x 1/8 x 1	4,365	10	662528 <b>43251</b>	662533 <b>06609 FC</b>	662533 <b>06611 LL</b>	
	4,365	5				
16 x 5/32 x 1	3,820	10	662528 <b>43255</b>	662534 <b>10183 FC</b>	662534 <b>10184 LL</b>	
18 x 5/32 x 1	3,015	10		662534 <b>10185 FC</b>		
20 x 5/32 x 1	2,710	5	662528 <b>43258 FC</b>	690786 <b>09031 FC</b>	690786 <b>09032 LL</b>	
	2,710	5	662528 <b>43259 LL</b>			
20 x 3/16 x 1	2,710	5		690786 <b>09033 FC</b>	690786 <b>09034 LL</b>	

**CUT-OFF WHEEL DESCRIPTION CODES**

BLANK = All Purpose    FC = Free Cut    LL = Long Life    ■ = Masonry    ■ = Stainless    ■ = Steel / Metal

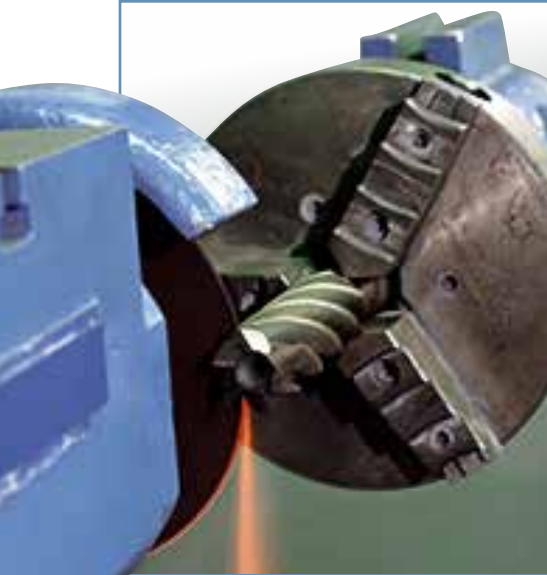

Reinforced and non-reinforced engineered cut-off wheels for cutting all types of tool steel with fixed-based cut-off machines.

**Applications:**

Reinforced cut-off wheels are designed to resist breakage caused by severe cross-bending and are required on any operation where the work is not securely clamped.

Non-Reinforced cut-off wheels are designed for use on fixed-based machines where the work is securely clamped, guarded, and where the wheel operates on a controlled cutting plane.

**Size range:**

6" – 12" diameter

**Grit range:**

36 – 90 grit

**Abrasive grain:**

Aluminum Oxide

**Bond:**

Resinoid, Rubber, and Shellac

**Shape:**

Type 01/41 Straight

### Cross Reference Guide

NORTON	BETTER		
	Reinforced A60-QBNA2	Reinforced 57A364-TB25N	Non-Reinforced 57A60-M8B
Bates	A602-T-BF	A36-R-BF	-
Buffalo	A60-R-BF2	-	-
Dia. Tool	A80-SP	A46-SP	-
Radiac	A54-N6-B20	-	A54-N6-B20
Tyrolit	A60-QBF38A2	-	-

### TECH TIP

- Smooth side pattern – Used when a precise thickness tolerance is needed
- Rough (R) side pattern – Abrasive particles protrude from sides of wheel

### Troubleshooting Guide

PROBLEM	POSSIBLE CAUSES	SUGGESTED CORRECTION
Poor cut rate	Insufficient power used	Increase feed or pressure to full power
	Wheel too hard	Use softer grade, or thinner wheel
	Contact area too large	Reduce contact area
	Wheel too coarse	Use finer grit
	Wheel side out of truth	Check spindle runout
Non-square cuts	Work not clamped properly	Check clamp and clean to remove swarf
	Misaligned spindle bearings	Check for bearing truth and alignment
	Poor coolant distribution	Ensure equal volume of coolant to each wheel side
	Wheel is too hard	Use softer acting wheel: softer grade, or finer grit
Workpiece burn	Insufficient feed rate	Work machine to maximum power available
	Poor coolant flow	Increase volume and direct at cutting point
	Wheel is too coarse	Use finer grit or more machine power
	Wheel is too hard	Use softer grade wheel
	Wheel is running out	Check spindle and flanges
	Wheel speed is too slow	Ensure tight flanges and maximum safe operating speed being used
Poor finish	Too much burr	Use finer grit, or softer grade
	Wheel too coarse	Use finer grit

### TECH TIP

- Wheels with a "W" reinforcement (reinforcement around the hole) are not considered to be truly reinforced.
- Clamp or fixture the workpiece for straightest cuts.
- Run wheels at the highest possible speed marked on the wheel and make cuts as quickly as possible. Do not overspeed wheels.
- It is recommended that a cut-off machine should have 1 horsepower for every inch of wheel diameter. For less than this, we recommend using a softer specification.
- Using a harder grade wheel increases wheel life, but it also increases burn, power required and decreases cut rate.
- Using a coarser grit wheel increases wheel life and cut rate, but it also increases burr and power required.



Better choice for cutting tool steel on fixed-based machines when work is not securely clamped



### TOOLROOM REINFORCED ALUMINUM OXIDE

- Tough, versatile aluminum oxide grain for toolroom cut-off applications
- Constructed with full diameter fiberglass reinforcement on each side of wheel, to provide greatest possible resistance to side pressure and bending
- OBNA2 full side reinforced, resin bond; yields maximum cut rate and minimum kerf loss; ideal when thin cut is desired
- B25N full side reinforced, resin bond; versatile; durable, free cutting; offer greatest stiffness

SIZE (D x T x H)	MAX. RPM	STD. PKG.	TIER: BETTER		PART #
			SPEC.		
<b>Type O1/41 Straight Cut-off – Reinforced</b>					
6 x .035 x 1/2	10,190	25	A60-OBNA2		662528 <b>35053</b>
6 x .035 x 1-1/4	10,190	25	A60-OBNA2		662528 <b>35055</b>
6 x .060 x 1/2	10,190	25	A60-OBNA2		662528 <b>35164</b>
6 x .060 x 1/2	10,190	25	57A364-TB25N		662528 <b>22969</b>
6 x .060 x 1-1/4	10,190	25	A60-OBNA2		662528 <b>35165</b>
7 x .035 x 1/2	8,730	25	A60-OBNA2		662529 <b>38786</b>
7 x .035 x 1-1/4	8,730	25	A60-OBNA2		662529 <b>38788</b>
7 x .060 x 1/2	8,730	25	A60-OBNA2		662529 <b>38816</b>
7 x .060 x 1-1/4	8,730	25	A60-OBNA2		662529 <b>38796</b>
7 x .060 x 1-1/4	8,730	25	57A364-TB25N		662529 <b>22676</b>

SIZE (D x T x H)	MAX. RPM	STD. PKG.	TIER: BETTER		PART #
			SPEC.		
<b>Type O1/41 Straight Cut-off – Reinforced</b>					
8 x .035 x 1/2	7,640	25	A60-OBNA2		662530 <b>43014</b>
8 x .035 x 1-1/4	7,640	25	A60-OBNA2		662530 <b>42980</b>
8 x .060 x 1/2	7,640	25	A60-OBNA2		662530 <b>43009</b>
8 x .060 x 1-1/4	7,640	25	A60-OBNA2		662530 <b>42983</b>
8 x .060 x 1-1/4	7,640	25	57A364-TB25N		662530 <b>22705</b>
10 x .060 x 5/8	6,110	25	A60-OBNA2		662531 <b>49317</b>
10 x .060 x 1-1/4	6,110	25	A60-OBNA2		662531 <b>49186</b>
12 x .060 x 1	5,095	10	A60-OBNA2		662532 <b>61811</b>
12 x .075 x 1	5,095	10	A60-OBNA2		662532 <b>61910</b>
12 x .075 x 1-1/4	5,095	10	A60-OBNA2		662532 <b>61858</b>

Better choice for cutting tool steel on fixed-based machines when the work is securely clamped



### TOOLROOM NON-REINFORCED ALUMINUM OXIDE

- Tough, durable and versatile aluminum oxide grain for toolroom cut-off applications
- Non-reinforced, use on fixed-based machines where the work is securely clamped
- B bond (smooth sides); a mild acting resin bond for light cut-off applications
- B25 bond (smooth sides); a versatile, free-cutting, more durable resin bond; ideal for dry cutting metal in high production runs
- E7 bond (smooth sides); a shellac bond with very mild cutting action, recommended for highly critical applications where no burr, heat checks, or discoloration is permitted
- R30 bond (smooth sides); mild acting rubber bond primarily for wet, ultra-thin cutting

SIZE (D x T x H)	MAX. RPM	STD. PKG.	TIER: BETTER		PART #
			SPEC.		
<b>Type O1/41 Straight Cut-off – Non-Reinforced</b>					
6 x .015 x 1-1/4	6,370	25	57A90-ROR30		662528 <b>22953</b>
6 x .020 x 1-1/4	6,370	25	57A90-ROR30		662528 <b>22954</b>
6 x .035 x 1-1/4	6,370	25	57A60-M8B		662528 <b>22958</b>
6 x .060 x 1/2	7,640	25	57A541-RB25		662528 <b>22970</b>
6 x .060 x 1-1/4	7,640	25	57A60-M8B		662528 <b>22975</b>
7 x .035 x 1-1/4	5,460	25	57A60-M8B		662529 <b>22983</b>
	5,460	25	57A60-Q8B		662529 <b>22986</b>
	5,460	25	57A60-Q8B		662529 <b>22987</b>
7 x .035 x 1-1/4	5,460	25	57A601-PB25		662529 <b>22988</b>
	5,460	25	57A601-RB25		662529 <b>22989</b>
7 x .035 x 1-1/4	5,185	25	57A60-OE7		662529 <b>22985</b>
7 x .035 x 1-1/4	5,460	25	23A601-PB25		662529 <b>38701</b>
7 x .050 x 1-1/4	5,460	25	23A601-PB25		662529 <b>38724*</b>
7 x .060 x 1/2	6,550	25	57A60-Q8B		662529 <b>22672</b>

\*Exception: rough sides

SIZE (D x T x H)	MAX. RPM	STD. PKG.	TIER: BETTER		PART #
			SPEC.		
<b>Type O1/41 Straight Cut-off – Non-Reinforced</b>					
7 x .060 x 1-1/4	6,550	25	57A46-M8B		662529 <b>22677</b>
	6,550	25	57A60-M8B		662529 <b>22681</b>
	6,550	25	57A60-Q8B		662529 <b>22684</b>
	5,185	25	57A60-OE7		662529 <b>22683</b>
7 x .090 x 1-1/4	6,550	25	57A60-M8B		662529 <b>22690</b>
7 x .125 x 1-1/4	6,550	25	57A60-M8B		662529 <b>22692</b>
8 x .035 x 1-1/4	4,775	25	57A60-N8B		662530 <b>22694</b>
8 x .060 x 1/2	5,730	25	57A60-M8B		662530 <b>22702</b>
8 x .060 x 1-1/4	5,730	25	57A60-M8B		662530 <b>22708</b>
8 x .060 x 1-1/4	4,540	25	57A60-OE7		662530 <b>22709</b>
10 x .060 x 5/8	4,585	25	57A46-Q8BW		662531 <b>22816</b>
	4,585	25	57A60-M8BW		662531 <b>22818</b>
10 x .090 x 5/8	4,585	25	57A60-M8BW		662531 <b>22824</b>

# Metallurgical Non-Reinforced Cut-off



The Norton metallurgical line of Type 01/41 straight cut-off wheels was developed specifically for sectioning off metal samples; burr-free cutting, minimal burn and distortion.

**Applications:**

Designed specifically for cutting off metal samples ranging from mild steel to super alloys on fixed-based machinery by scientists, engineers, and lab technicians.

**Size range:**

9" – 13.75" diameter

## Cross Reference Guide

SIZE	MATERIAL CUT	NORTON		BUEHLER		LECO		STRUERS	
		SPEC.	PART #	METABRASE PART #	BUEHLERMET II PART #	PART #	PART #	PART #	AXITOM/-5 PART #
9 x .063 x 1-1/4 (229mm x 1.6mm x 32mm)	Very Hard Steels (Rc 55 - 68)	ML-109	662531 <b>17874</b>	10-4110-010					60A24*
	Medium Steels (Rc 30 - 40)	ML-309	662531 <b>17877</b>	10-4116-010	10-5112-010	811-043-010			40A24*
	Soft Steels (Rc 20 - 30)	ML-409	662531 <b>17828</b>	10-4120-010	10-5116-010	811-049-010			30A24*
10 x .063 x 1-1/4 (254mm x 1.6mm x 32mm)	Very Hard Steels (Rc 55 - 68)	ML-110	662531 <b>17879</b>	10-4210-010		808-673	812-231		60A25•
	Hard Steels (Rc 40 - 55)	ML-210	662531 <b>17880</b>	10-4212-010	10-5210-010	811-059-010	810-310-010		54A25•
	Medium Steels (Rc 30 - 40)	ML-310	662531 <b>17881</b>	10-4216-010	10-5212-010	811-067-010	810-310-010		40A25•
	Soft Steels (Rc 20 - 30)	ML-410	662531 <b>17830</b>	10-4220-010	10-5216-010	811-073-010			30A25•
12 x .078 x 1-1/4 (305mm x 2.0mm x 32mm)	Very Hard Steels (Rc 55 - 68)	ML-112	662533 <b>22151</b>	10-4410-010		808-674	811-065-010		60A30†
	Hard Steels (Rc 40 - 55)	ML-212	662533 <b>22152</b>	10-4412-010	10-5410-010	811-081-010	810-311-010		50A30†
13.75 x .098 x 1-1/4 (350mm x 2.5mm x 32mm)	Very Hard Steels (Rc 55 - 68)	ML-114	662533 <b>22863</b>	10-4310-010		808-675	812-232		60A35▲ 50A35
	Hard Steels (Rc 40 - 55)	ML-214	662533 <b>22156</b>	10-4312-010	10-5310-010	809-346	811-977-010		50A35▲ 40A35

\*Discotom/Labotom • Discotom-5/-6/Labotom-3 † Unitom/Discotom-50/-60/-65 ▲ Exotom/Unitom-2/-5/-50



Best choice for wet use when you want burn-free cuts and ultra-clean samples

## METLAB 38A ALUMINUM OXIDE

- Quality aluminum oxide abrasive wheel designed specifically for burr-free cutting of soft carbon steels, tool steels, super alloys for microscopic metal analysis
- Superior bond system generates pure cuts for sectioning off samples while minimizing wheel wear and odor
- Designed to work on Buehler®, LECO® and Struers® machinery

SIZE (D x T x H)	MAX. RPM	STD. PKG.	PRODUCT #	APPLICATION	TIER: BEST PART #
<b>Type 01/41 Straight Cut-off – Non-Reinforced</b>					
9 x .063 x 1-1/4 (229mm x 1.6mm x 32mm)	4,025	10	ML-109	Very Hard Steels (Rc 55 - 68)	662531 <b>17874</b>
	4,025	10	ML-309	Medium Steels (Rc 30 - 40)	662531 <b>17877</b>
	5,085	10	ML-409	Soft Steels (Rc 20 - 30)	662531 <b>17828</b>
10 x .063 x 1-1/4 (254mm x 1.6mm x 32mm)	3,500	10	ML-110	Very Hard Steels (Rc 55 - 68)	662531 <b>17879</b>
	3,500	10	ML-210	Hard Steels (Rc 40 - 55)	662531 <b>17880</b>
	3,500	10	ML-310	Medium Steels (Rc 30 - 40)	662531 <b>17881</b>
	4,585	10	ML-410	Soft Steels (Rc 20 - 30)	662531 <b>17830</b>
12 x .078 x 1-1/4 (305mm x 2.0mm x 32mm)	3,820	10	ML-112	Very Hard Steels (Rc 55 - 68)	662533 <b>22151</b>
	3,820	10	ML-212	Hard Steels (Rc 40 - 55)	662533 <b>22152</b>
13.75 x .098 x 1-1/4 (350mm x 2.5mm x 32mm)	2,770	10	ML-114	Very Hard Steels (Rc 55 - 68)	662533 <b>22863</b>
	2,770	10	ML-214	Hard Steels (Rc 40 - 55)	662533 <b>22156</b>

SIZE (D x T x H)	MAX. RPM	STD. PKG.	SPEC.	PART #
<b>Type 01/41 Straight Cut-off – Non-Reinforced</b>				
10 x 1/16 x 1-1/4	4,585	5	88A901-HB82 Metlab	662531 <b>49449</b>
12 x 1/16 x 1-1/4	3,820	5	88A901-HB82 Metlab	662532 <b>62172</b>



The Norton RailCut line is designed for high-speed fixtured hydraulic or gas-powered rail saws.

- Applications:** Fixed rail track cutting
- Size range:** 14" and 16" diameter
- Thickness range:** 1/8"
- Grit range:** 14 – 16
- Abrasive grain:** Zirconia Alumina / Aluminum Oxide Blend, Zirconia Alumina, and Aluminum Oxide
- Shape:** Type 01/41 Straight
- Reinforcement:** Side reinforced with R (rough) sides
- Speed rating:** All wheels are rated for 20,000 SFPM applications
- Machines Used:**



FIXTURED HYDRAULIC OR  
GAS-POWERED RAIL SAW

## Cross Reference Guide and Machine-to-Product Recommendation Guide

	BEST	BETTER	GOOD	GOOD
NORTON	RailCut X	RailCut NorZon III	RailCut A30X	RailCut Metal
Bullard Abrasive	Trackmaster Pro ZA24 Q-BF (Blue)	Trackmaster Pro ZA24 Q-BF (Blue)	Trackmaster A30 R-BF (Red)	—
DiaTool	—	—	—	RailMaster Rail Cut 27
Flexovit USA	—	—	A30-PB	—
Giesmar	AM303-R	AM303-R	NR242-Q	NR242-Q
Klingspor	A 24 SX Special	A 24 SX Special	—	—
Portaco	A30 R-BF	A30 R-BF	—	—
Racine Kwik Kut	A24R	A24R	—	—

	BEST	BETTER	GOOD	GOOD	
	RailCut X	RailCut NorZon III	RailCut NorZon III FastCut	RailCut A30X	RailCut Metal
<b>HYDRAULIC SAW</b>	◆	—	—	◆	◆
<b>GAS SAW</b>	—	—	—	—	—
High-Horsepower / Newer Machine	◆	◆	—	◆	◆
Low-Horsepower / Older Machine	◆	◆	◆	◆	◆



Best choice for high-performance cutting of rails on applications where the hydraulic or gas saw is fixtured and has adequate power

### RAILCUT X ZIRCONIA ALUMINA / A/O BLEND

- Highest-performance zirconia alumina and engineered aluminum oxide abrasive blend expertly cuts a broad range of rail material
- Rough sides enable fastest cutting and longest lasting wheels
- Achieve highest productivity with lowest total abrasive costs



Good choice for price-sensitive jobs with lowest initial price

### RAILCUT METAL ALUMINUM OXIDE

- Quality aluminum oxide abrasive wheels designed for jobs where low initial price is a key purchasing criterion
- Side reinforced with rough sides; rated for 20,000 SFPM applications
- Designed for multi-purpose use; great versatility on a variety of rail materials



	TIER: BEST	BETTER	BETTER	GOOD	GOOD		
TRADENAME:	RAILCUT X	RAILCUT NORZON III	RAILCUT NORZON III FASTCUT	RAILCUT A30X	RAILCUT METAL		
ABRASIVE:	Zirconia Alumina / Aluminum Oxide Blend	Zirconia Alumina	Zirconia Alumina	Aluminum Oxide	Aluminum Oxide		
SIZE (D x T x H)	MAX. RPM	STD. PKG.	PART #	PART #	PART #		
<b>Type 01/41 Cut-Off</b>							
14 x 1/8 x 1	5,400	10	662533 <b>37716</b>	662533 <b>60493</b>	662533 <b>63694</b>	662532 <b>60462</b>	662434 <b>82068</b>
16 x 1/8 x 1	4,800	10	662533 <b>35024</b>	662534 <b>64607</b>	662534 <b>64415</b>	662532 <b>59935</b>	662434 <b>82066</b>



Foundry cut-off wheels are designed with abrasives, bonds and reinforcement types specific to foundry machine parameters and materials. Most of the specifications are non-stock. This stock listing is designed to provide popular size and starting specifications.

- Size Range:** Reinforced: 14" – 30" diameter; Non-reinforced: 12" – 20" diameter
- Grit Range:** 24 – 46 grit
- Abrasive Grain:** Ceramic Alumina (Norton Quantum; non-stock only), Zirconia Alumina, Aluminum Oxide
- Reinforcement:** Reinforced: Engineered with strengthening fabric or filaments, which make wheels resistant to cross-bending breakage. All portable cut-off, swingframe, locked-head push-through and foundry chop stroke operations require reinforced cut-off wheels.
- B:** One or more full diameter pieces of filament molded inside each wheel. This construction leaves the abrasive exposed on the side of the wheel, improving freeness of cut. Used for fixed work operations with low probability of side pressure.
- N:** Full diameter pieces of reinforcement on the side of the wheel. Offers greatest possible resistance to side pressure and bending.
- Non-Reinforced:** Designed for use on fixed-base types of machines where the work is securely clamped and guarded, and where the wheel operates on a controlled cutting plane.
- W:** Reinforcement around the center hole only. These wheels are not considered to be truly reinforced.
- Side Patterns:** Smooth sides: Used for precision cutting applications  
 Rough (R) sides: Abrasive particles protrude from sides of wheel  
 Used wet or dry on most metals

### Material-to-Product Recommendation Guide

	BEST	BETTER	GOOD	GOOD
	Foundry X Quantum*	Foundry X BlueFire	Foundry X	Foundry Metal
<b>INVESTMENT CAST ALLOYS</b>				
Stainless Steel	◆	◆	◆	◆
Titanium	◆	◆	◆	◆
<b>CAST IRON</b>				
	◆	◆	◆	◆
<b>CAST STEEL</b>				
Carbon and Low Alloy	◆	◆	◆	◆
Stainless Steel and High Alloy	◆	◆	◆	◆
Aluminum Alloy	◆	◆	◆	◆
Copper Alloys, Brass, Bronze	◆	◆	◆	◆

\*Foundry X Quantum wheels are non-stock, custom-made to your requirements

### Cross Reference Guide

	TOTAL PERFORMANCE		INITIAL PRICE	
	BEST	BETTER	GOOD	GOOD
NORTON	Foundry X Quantum and B97 (Non-stock; custom-made to your exact requirements)	Foundry X BlueFire	Foundry X	Foundry Metal
Allison	TA362 R6 8045HA, YW462 MR B2HA	TA302-T6-B6HA, A46-T6-BX5T6A, HF 1247 K – CHALLENGER	—	Economiser
Avery	—	TA30-V680	A 3226 C7A, C11922 W071	92871H
Buckeye	—	Steel Shark	—	—
DiaTool	BV1734R 710	BV 1397-5284-C	—	—
Flexovit	—	ZAX30TB	A24PB, A30RB	—
Klingspor	20A24-QBF	—	—	—
NATAB	—	—	T 1584 HA	—
Rappold	—	6Z30U-B3F2	—	—



Better choice on stainless steel, aerospace alloys, cast iron, and steel

## FOUNDRY X BLUEFIRE REINFORCED

- Next generation self-sharpening zirconia alumina abrasive provides fast cuts on foundry cut-off applications
- Improved durability and heat resistance result in longer abrasive life
- More aggressive; can withstand very demanding applications



Good choice on general purpose applications

### FOUNDRY X ALUMINUM OXIDE

- Durable, versatile aluminum oxide abrasive engineered for consistent performance and economical price on foundry cut-off applications
- Advanced bond technology with improved thermal stability and mechanical strength
- Excellent value on stainless steel and exotic aerospace alloys



Good choice for price-sensitive jobs with lowest initial price

### FOUNDRY METAL ALUMINUM OXIDE

- Great versatility from multi-purpose aluminum oxide abrasive formulated specifically for typical foundry applications
- Bond and reinforcement engineered to foundry market machine parameters and materials
- Good choice for small jobs and quick applications where performance is not measured

### Reinforced



TIER:	<b>BETTER</b>	<b>GOOD</b>	<b>GOOD</b>
TRADENAME:	<b>FOUNDRY X BLUEFIRE</b>	<b>FOUNDRY X</b>	<b>FOUNDRY METAL</b>
ABRASIVE:	Zirconia Alumina / Aluminum Oxide	Aluminum Oxide	Aluminum Oxide

SIZE (D x T x H)	MAX. RPM	STD. PKG.	SPEC.	PART #	SPEC.	PART #	SPEC.	PART #
<b>Type 01/41 Straight Cut-off – Foundry Reinforced</b>								
14 x 1/8 x 1	4,365	10	NV24-TB75N	662533 <b>47674</b>	U57A30-TB75N	662533 <b>45779</b>	Side Reinforced	662434 <b>85918</b>
	4,365	10	NV24-VB75N	662531 <b>79193</b>	U57A30-VB75N	662531 <b>79191</b>		
	4,365	10	NV24-YB97N	662533 <b>47698</b>				
16 x 5/32 x 1	3,820	10	NV24-TB75N	662533 <b>47676</b>	U57A30-TB75N	662533 <b>45781</b>	Side Reinforced	662434 <b>85919</b>
	3,820	10	NV24-VB75N	662531 <b>79147</b>	U57A30-VB75N	662531 <b>79148</b>		
	3,820	10	NV24-YB97N	662533 <b>47693</b>				
20 x 5/32 x 1	2,710	10	NV24-TB75N	662533 <b>47683</b>	U57A30-TB75N	662533 <b>47546</b>	Side Reinforced	662434 <b>85920</b>
	2,710	10	NV24-VB75N	662531 <b>79363</b>	U57A30-VB75N	662531 <b>79364</b>		
	2,710	10	NV24-YB97N	662533 <b>47694</b>	U57A30-YB97N	662533 <b>47701</b>		
20 x 3/16 x 1	2,710	10	NV24-TB75B	662533 <b>47684</b>	U57A30-TB75B	662533 <b>47547</b>	Centrally Reinforced	662434 <b>85921</b>
	2,710	10	NV24-VB75B	662531 <b>79366</b>	U57A30-VB75B	662531 <b>79367</b>		
	2,710	10	NV24-YB97B	662533 <b>47699</b>	U57A30-YB97B	662533 <b>47702</b>		
24 x 7/32 x 1-3/4	2,260	10	NV24-TB75B	662533 <b>47685</b>				
	2,260	10	NV24-VB75B	662531 <b>79374</b>	U57A30-VB75B	662531 <b>79375</b>		
	2,260	10	NV24-YB97B	662533 <b>47697</b>				
30 x 1/4 x 1-3/4	1,810	10	NV24-TB75B	662533 <b>47722</b>	U57A30-TB75B	662533 <b>47720</b>		
	1,810	10	NV24-YB97B	662533 <b>47723</b>	U57A30-YB97B	662533 <b>47721</b>		

Specifications ending in "B" are centrally reinforced; specifications ending in "N" are side reinforced.

### Non-Reinforced



TIER:	<b>BETTER</b>	<b>GOOD</b>
TRADENAME:	<b>U57A</b>	<b>GEMINI</b>
ABRASIVE:	Aluminum Oxide	Aluminum Oxide

SIZE (D x T x H)	MAX. RPM	STD. PKG.	SPEC.	PART #	SPEC.	PART #
<b>Type 01/41 Straight Cut-off – Foundry Non-Reinforced R-Sides</b>						
12 x 3/32 x 1	5,095	10	U57A461-PB25	662532 <b>61887</b>		
16 x 1/8 x 1	3,820	10			AP	662534 <b>22942</b>
20 x 1/8 x 1	2,710	10	U57A304-VB25W	690786 <b>65497</b>		

Ask your Norton representative about our custom, made-to-order Norton Foundry X Quantum ceramic alumina wheels for high alloys, stainless steel, and aerospace applications.

#### CUT-OFF WHEEL DESCRIPTION CODES

AP = All Purpose

Where a good blend of cut rate and life is needed



For consistent, quality performance in foundries, welding shops, fabrication facilities, steel mills and shipyards, Norton portable snagging wheels maximize your productivity. Used on horizontal/straight shaft grinders or right angle portable cup grinders.

- Applications:** Removing flaws, cracks, gates, risers and parting lines, smoothing weld seams, cleaning castings, and rough beveling
- Size Range:** Type 01 Straight Wheels: 2-1/2" – 8" diameter  
Type 06 and 11 Cup Wheels: 4" – 6" diameter  
Cones and Plugs: Type 16, 17, 17R, 18 and 18R
- Grit Range:** 14 – 24
- Abrasive Types:** Zirconia Alumina NZ and NV; Zirconia Alumina / Silicon Carbide Blend NVC; Aluminum Oxide 57A and Metal; Aluminum Oxide / Silicon Carbide Blend 57AC, Silicon Carbide 37C and Masonry

**Machine Used:**



### Material-To-Product Recommendation Guide

	BEST	BETTER	GOOD	
	NorZon Plus	BlueFire	Gemini	Metal
<b>IRON</b>				
Gray	◆ NZ14-R	◆ NV16-Q	◆ 57A16-Q	◆
Ductile/Malleable	◆ NZ14-R	◆ NV16-Q	◆ 57A16-Q	◆
Dirty/Scale-covered		◆ NVC16-Q	◆ 57AC16-Q	
<b>STEEL</b>				
Carbon and Low Alloy	◆ NZ14-Q	◆	◆ 57A16-Q	◆
Stainless and High Alloy	◆ NZ14-P	◆	◆ 57A16-Q	◆
<b>ALUMINUM, COPPER, BRASS, &amp; BRONZE ALLOYS</b>				
		◆ NVC16-Q	◆ 57AC16-Q	

*NOTE: Grade, Grit and Abrasive tuning may be necessary to obtain optimum performance*

### Cross Reference Guide for Type 01, 06 and 11 Wheels

	TOTAL PERFORMANCE ←			→ INITIAL PRICE	
	BEST	BETTER	GOOD		
NORTON	NorZon Plus	BlueFire NV	Gemini 57A/Metal	Gemini 57AC	Gemini 37C/Masonry
Brilliant	—	ZA16QB	A16QB	—	C16QB
Bullard	—	ZA16PB	A16R	AC16	C16P
Camel	—	—	A	CA	C
Flexovit	ZA16PB	—	A16QB	AC16QB	C16PB
Gulf States	Zirconium	—	A16	—	C16
Pacific	Z, Z-GPC	—	A	CA	—
Pearl	—	—	A16Q	—	C16-Q
Pferd	ZA 16 Q SG	—	A 16 Q SG	—	C 16 Q SG
Sait	—	Z16	A16, 20	CA16	C16
Tyrolit	—	—	A16PB	—	C16PB
Walter	—	—	A	—	C

Best choice for heavy-duty stock removal on medium- and high-horsepower grinders



## NORZON PLUS ZIRCONIA ALUMINA

- Tough, durable, premium zirconia alumina grain provides 10X life and 50% faster grinding versus aluminum oxide products
- Engineered to excel on the toughest foundry snagging applications
- Best performance on a wide variety of materials; 300 and 400 series stainless, soft and hard carbon steels, tool steels, titanium, super alloys, soft metals, and cast, ductile and gray iron

Better choice for stock removal on high- and medium-horsepower grinders



## BLUEFIRE ZIRCONIA ALUMINA

- Friable zirconia alumina grain and durable resin bond technologies deliver sharper grain longer, for extended wheel life, higher metal removal rates, and faster, freer cutting action than standard zirconia alumina blends
- Ideal for foundry snagging, tool sharpening, portable grinding and stock removal applications on high- and medium-horsepower grinders
- Strong operator preference for these smooth-acting wheels that require less pressure and exertion, while improving productivity
- NVC – zirconia alumina / silicon carbide blend is highly effective on dirty, scale-covered castings
- Available with low odor bond to help reduce odors associated with portable grinding when used in confined spaces

Good choice for steel and ferrous metals as well as specialty applications in aluminum and foundries



## GEMINI ALUMINUM OXIDE

- Tough, durable aluminum oxide abrasive for heavy-duty work including foundry snagging, tool sharpening, and stock removal
- Work well with a variety of machines, horsepower, and operations
- Good general-purpose choice for numerous small jobs
- Available with low odor bond to help reduce odors associated with portable grinding when used in confined spaces

Good choice for steel/ferrous metal applications with low initial price



## METAL ALUMINUM OXIDE

- Tough, durable aluminum oxide abrasive for heavy-duty work including foundry snagging, tool sharpening, and stock removal
- Work well with a variety of machines, horsepower, and operations
- Good general-purpose choice for numerous small jobs on 300 and 400 series stainless, soft and hard carbon steels, tool steels, titanium, super alloys, soft metals, and cast, ductile and gray iron

Good choice for masonry applications with low initial price



## MASONRY ALUMINUM OXIDE

- Sharp silicon carbide abrasive for small-volume snagging jobs
- Delivers rapid stock removal in small areas on a portable cup grinder
- Versatile; good starting specification where initial price is a primary purchasing consideration, especially nonferrous and masonry



TIER:	BEST	BETTER	GOOD	GOOD
TRADENAME:	<b>NORZON PLUS</b>	<b>BLUEFIRE</b>	<b>GEMINI</b>	<b>METAL/MASONRY</b>
SHAPE:	Type 01 and 11	Type 01, 06, and 11	Type 01 and 11	Type 11
ABRASIVE:	Premium Zirconia Alumina	Zirconia Alumina NV Zirconia Alumina/ Silicon Carbide NVC	Aluminum Oxide 57A, Silicon Carbide 37C, Aluminum Oxide/ Silicon Carbide 57AC	Metal – Aluminum Oxide Masonry – Silicon Carbide

SIZE (D x T x H)	MAX. RPM	STD. PKG.	SPEC	PART #	SPEC	PART #	SPEC	PART #	SPEC	PART #
<b>Type 01 Straight</b>										
2-1/2 x 1/2 x 3/8	21,700	20					57A24-R	662435 <b>22381</b>		
3 x 1/4 x 3/8	20,370	25			NV20-T	662533 <b>43872*</b>	57A24-T	662435 <b>28831</b>		
3 x 3/8 x 3/8	18,080	10					57A24-R	662435 <b>22415</b>		
3 x 1/2 x 3/8	18,080	10					57A24-P	662435 <b>22417</b>		
4 x 1/4 x 3/8	15,280	10			NV20-T	662533 <b>44098</b>	57A24-R	662435 <b>22221</b>		
6 x 1 x 5/8	8,000	5			NV14-R	662531 <b>98589</b>	57A16-QS	662528 <b>09563</b>		
S Webs	8,000	5			NZ III 14-Q	662528 <b>38075</b>				
	8,000	5			NZ III 14-R	662528 <b>37961</b>				
8 x 3/4 x 5/8	6,000	10			NV14-S	662533 <b>44347</b>				
S Webs										
8 x 1 x 5/8	6,000	5	NZ IV 16-Q	662530 <b>30778</b>	NV16-Q	662531 <b>98590</b>				
S Webs	6,000	5	NZ IV 16-Q	662530 <b>44532</b>						
	6,000	10			NV14-R	662533 <b>44355</b>				
	6,000	10			NV14-T	662533 <b>44365</b>				
	6,000	10			NVC16-Q	662531 <b>98592</b>				
<b>Type 06 Straight Cup</b>										
6 x 2 x 5/8-11	6,000	5			NZ III 16-R	662528 <b>38577</b>				
Rim 2" Back 3/4"										
<b>Type 11 Flaring Cup</b>										
4/3 x 2 x 5/8-11	9,070	10	NZ IV 16-Q	662435 <b>30761</b>	NV16-Q	662531 <b>98583</b>	57A16-Q	662435 <b>10512</b>	Masonry C16-Q	076607 <b>89431</b>
Rim 3/4" Back 3/4"										
5/3-3/4 x 2 x 5/8-11	7,260	5			NV16-Q	662531 <b>46918</b>	57A16-Q	662528 <b>09598</b>	Metal 16-Q	076607 <b>89430</b>
Rim 1" Back 3/4"	7,260	5			4NZ16-Q RB	690786 <b>40233</b>	57AC16-Q RB	690786 <b>40234</b>		
6/4-3/4 x 2 x 5/8-11	6,000	5			NV16-Q	662531 <b>46925</b>	57A16-Q	662528 <b>25201</b>		
Rim 1" Back 3/4"	6,000	5			NZ III 16-Q	662528 <b>38568</b>				
6/4-3/4 x 2 x 5/8-11	6,000	5	NZ IV 16-P	662528 <b>30765</b>	NV14-R	662533 <b>44371</b>	37C16-P	662528 <b>09609</b>		
Rim 1-1/2" Back 3/4"	6,000	5			NV16-Q	662531 <b>98584</b>	57A16-Q	662528 <b>09618</b>		
	6,000	5			NVC16-Q	662531 <b>46922</b>	57AC16-Q	662528 <b>09608</b>		
	6,000	5			4NZ16-Q RB	690786 <b>40484</b>	9CA16-Q RB Ti	690786 <b>40488</b>		
							57AC16-Q RB	690786 <b>40485</b>		
<b>Type 11 Flaring Cup with Steel Back</b>										
4/3 x 2 x 5/8-11	9,070	10			NV16-Q	662531 <b>46917</b>				
Rim 3/4" Back 3/4"										
5/3-13/16 x 2 x 5/8-11	7,260	10			NV16-Q	662531 <b>46920</b>				
Rim 1" Back 3/4"										
6/4-13/16 x 2 x 5/8-11	6,000	5			NV14-R	662533 <b>44373</b>	57A16-Q	662528 <b>09599</b>		
Rim 1-1/2" Back 3/4"	6,000	5			NV16-Q	662531 <b>98586</b>	57AC16-Q	662528 <b>09600</b>		
	6,000	5			NVC16-Q	662531 <b>46929</b>	57AC16-Q RB	690786 <b>40486</b>		
	6,000	5			4NZ16-Q RB	690786 <b>40487</b>	9CA16-Q RB Ti	690786 <b>40489</b>		

\* Std. Pkg. = 50

RB = Low odor bond. Note: Ti formulation optimized for grinding Titanium

## TECH TIP

Norton BlueFire and Gemini Type 11 cup wheels now available in new RB low odor bond to help reduce odors associated with portable grinding when used in confined spaces.





TIER:	BEST	BETTER	GOOD	GOOD
TRADENAME:	<b>NORZON PLUS</b>	<b>BLUEFIRE</b>	<b>GEMINI</b>	<b>METAL</b>
ABRASIVE:	Zirconia Alumina	Zirconia Alumina/Aluminum Oxide	Aluminum Oxide	Aluminum Oxide

SIZE (D x T x H)	MAX. RPM	STD. PKG.	SPEC	PART #	SPEC	PART #	SPEC	PART #	SPEC	PART #
<b>Type 16 Cones</b>										
1 x 3 x 3/8-24 (ME 107019)	36,290	10			NV20-S	662533 <b>44376</b>	57A24-R	614636 <b>22342</b>	Metal 24	662533 <b>49752</b>
1-1/2 x 2-1/2 x 3/8-24 (ME 44436)	24,190	10					57A24-R	614636 <b>22349</b>	Metal 24	662533 <b>49754</b>
1-1/2 x 2-1/2 x 5/8-11 ME 171651	24,190	10					57A24-R	690786 <b>40166</b>	Metal 20	690786 <b>40046</b>
1-1/2 x 3 x 3/8-24 (ME 139029)	24,190	10			NV20-S	662533 <b>44377</b>				
1-1/2 x 3 x 3/8-24 (ME 171652)	24,190	10							Metal 20	690786 <b>40215</b>
1-1/2 x 3 x 5/8-11 (ME 70535)	24,190	10	NZ IV 20-R	614636 <b>44231</b>	NV20-S	662533 <b>44379</b>	57A24-R	614636 <b>22190</b>	Metal 24	662533 <b>49757</b>
1-3/4 x 3 x 3/8-24 (ME49226)	20,735	10					57A24-R	614636 <b>14503</b>	Metal 24	662533 <b>49840</b>
1-3/4 x 3 x 5/8-11 (ME 33432)	20,740	10					57A24-R	614636 <b>22195</b>	Metal 24	662533 <b>49841</b>
2 x 3 x 3/8-24 ME 157287	18,145	10							Metal 24	662534 <b>76413</b>
2 x 3 x 5/8-11 (ME 28229)	18,145	10	NZ IV 20-R	614636 <b>44232</b>	NV20-S	662533 <b>44381</b>	57A24-R	614636 <b>22218</b>	Metal 24	662533 <b>49846</b>
2-3/4 x 3-1/2 x 5/8-11 (ME 18265)	13,195	10			NV20-S	662533 <b>44383</b>	57A24-R	614636 <b>22387</b>	Metal 24	662533 <b>49855</b>
3 x 3 x 5/8-11 (ME70537)	12,100	10							Metal 24	662434 <b>96885</b>
<b>Type 17 Cones, Square Tip</b>										
1-1/2 / 1/2 x 3 x 3/8-24	24,190	10					57A24-R	614636 <b>22194</b>	Metal 24	662533 <b>49753</b>
1-1/2 / 1/2 x 3 x 5/8-11	24,190	10					57A24-R	690786 <b>40225</b>	Metal 20	690786 <b>40224</b>
2 / 1/2 x 3 x 5/8-11	18,145	10					57A24-R	614636 <b>15722</b>	Metal 24	662533 <b>49845</b>
<b>Type 17R Cones, Round Tip</b>										
2 / 3/4 x 3 x 5/8-11 (ME 151373)	18,145	10			NV20-S	662533 <b>44384</b>				
<b>Type 18 Plugs, Square Tip</b>										
1-1/2 x 2-1/2 x 3/8-24	24,190	10					57A24-R	614636 <b>22217</b>	Metal 24	662533 <b>49755</b>
	24,190	1	V				57A24-R	662533 <b>25902</b>		
1-1/2 x 2-1/2 x 5/8-11	24,190	10	NZ IV 20-R	614636 <b>44224</b>	NV20-S	662533 <b>44385</b>	57A24-R	614636 <b>22351</b>	Metal 20	690786 <b>40226</b>
	24,190	1	V				57A24-R	662533 <b>25905</b>		
1-1/2 x 3 x 5/8-11	24,190	10			NV20-S	662533 <b>44386</b>	57A24-R	614636 <b>22191</b>	Metal 24	662533 <b>49838</b>
	24,190	1	V				57A24-R	662533 <b>25909</b>		
2 x 3 x 5/8-11	18,145	10	NZ IV 20-R	614636 <b>44234</b>	NV20-S	662533 <b>44387</b>	57A24-R	614636 <b>22219</b>	Metal 24	662533 <b>49847</b>
	18,145	10			NV24-S	662533 <b>44391</b>				
2 x 4 x 5/8-11	18,145	10					57A24-R	614636 <b>22366</b>	Metal 24	662533 <b>49850</b>
<b>Type 18R Plugs, Round Tip</b>										
1-1/2 x 2-1/2 x 3/8-24	24,190	10					57A24-R	690786 <b>40230</b>	Metal 20	690786 <b>40229</b>
1-1/2 x 2-1/2 x 5/8-11	24,190	10					57A24-R	690786 <b>40228</b>	Metal 20	690786 <b>40227</b>
1-1/2 x 3 x 3/8-24	24,190	10					57A24-R	614636 <b>22192</b>	Metal 24	662533 <b>49756</b>
1-1/2 x 3 x 5/8-11	24,190	10							Metal 24	662434 <b>95628</b>
2 x 3 x 5/8-11	18,145	10			NV20-S	662533 <b>44389</b>	57A24-R	614636 <b>22220</b>	Metal 24	662533 <b>49849</b>
3 x 3 x 3/8-24	12,095	10					57A24-R	690786 <b>40232</b>		
3 x 3 x 5/8-11	12,095	10							Metal 20	690786 <b>40231</b>

V = Vendible Package. Ideal for vending machines and small jobs.

### Core Files

These files consist of coarse grit silicon carbide abrasive in a hard grade, resin-bonded to a reinforcing rod. Half-round in shape, they are a frequent choice for easy cleaning of rough castings.



TIER:	GOOD
ABRASIVE:	Silicon Carbide

SIZE (T x W x L)	STD. PKG.	SPEC.	PART #
<b>Stock Resinoid Core Files – Silicon Carbide</b>			
1/2 x 1 x 10	5	37C24-SB	614636 <b>10314</b>

# Floorstand and Swingframe Snagging



Norton snagging wheels maximize your productivity in foundries, welding shops, fabrication facilities, steel mills, and ship yards.

- Applications:** Removing unwanted metal on castings, removing flaws and cracks, removing gates, risers and parting lines
- Size Range:** 24" and 30" diameters in stock; other diameters available as made-to-order
- Abrasive Grain:** Zirconia Alumina, Zirconia Alumina/Silicon Carbide blend, Aluminum Oxide
- Shape:** Type 01 Straight
- Reinforcement:** Strong fiberglass webbing and steel rings for maximum strength

## Floorstand Snagging Wheel Material-to-Product Recommendation Guide

	BEST					BETTER		GOOD
	4ZF1434-R5B38S	4ZF1434-Q5B38S	4NZ1434-R5B38S	4NZ1434-Q5B38S	ZI/25-R	ZI/26-Q	Charger	Gemini All Purpose
<b>IRON</b>								
Gray	◆				◆	◆	◆ Long Life	◆
Ductile/Malleable		◆			◆	◆	◆ Long Life	◆
<b>STEEL</b>								
Carbon and Low Alloy			◆				◆ Free Cut	◆
Stainless and High Alloy				◆			◆ Free Cut	◆

Note: Grade, Grit and Abrasive tuning may be necessary to obtain optimum performance

## Swingframe Snagging Wheel Material-to-Product Recommendation Guide

	BEST				GOOD	
	4ZF1234-R5B38S	4ZF1434-R5B38S	NZC142-R5B38S	ZI/25-R	ZI/26-Q	Gemini All Purpose
<b>IRON</b>						
Gray		◆			◆	◆
Ductile/Malleable		◆			◆	◆
<b>STEEL</b>						
Carbon and Low Alloy			◆			◆
Stainless and High Alloy						◆
<b>ALUMINUM ALLOY</b>						
<b>COPPER ALLOYS / BRASS / BRONZE</b>						

Note: Grade, Grit and Abrasive tuning may be necessary to obtain optimum performance

## Troubleshooting Guide

PROBLEM	POSSIBLE CAUSES	SUGGESTED CORRECTION
Poor stock removal	Insufficient pressure applied	Increase pressure to use all available power
	Wheel too coarse or hard	Use finer grit and/or softer grade wheel
	Inadequate abrasive	Try NorZon, 4ZF, or ZI/25 specification
Grinding costs too high	Wheel acting too soft	Use harder and/or coarser wheel
	Low performance specification	Try NorZon or ZI products
Wheel loading or glazing	Grade too hard	Try softer grade
	Grit too coarse	Try finer grit
	Dirty, scale-covered parts	Try NZC wheels
Wheels "dusty"	Wheel too soft	Try harder grade
Wheel doesn't hold corner or wheel spalling	Wheel too coarse	Use finer grit and/or 2 grit combination
	Wheel too soft	Use harder grade
Burning the workpiece	Wheel too hard	Use softer grade
	Wheel glazed or loaded	Dress the wheel face
	Grinding pressure too low	Increase grinding force
	Grinding pressure too high	Reduce grinding force
Surface finish too rough	Wheel too coarse	Try finer grit or try ZI/26 specification
	Wheel speed too slow	Try higher speed machine (Do not exceed maximum operating speed of wheel)
	Worn machine bearings	Rebuild machine
Vibration	Wheel worn out of round	Try truing the wheel
	Faulty flanges	Check flanges for flatness and burrs (see ANSI B7.1)
	Bent machine spindle	Check spindle run-out
	Worn machine bearings	Rebuild machine
Wheel stalls or slows	Grinding force too high	Reduce pressure or contact area
	Wheel too hard	Use softer grade wheel
	Machine power too low	Replace machine with higher power grinder

Best choice for demanding applications

## 4ZF, 4NZ, ZI, AND NZC ZIRCONIA ALUMINA

- Zirconia alumina abrasive engineered for high-pressure, heavy duty, snagging operations including foundry snagging and stock removal
- These wheels have high-speed steel rings with fine centers and reinforcing webs for added safety
- 4ZF – zirconia alumina grain for exceptional wheel life; engineered for high-pressure, heavy-duty, snagging operations, particularly on iron
- 4NZ – zirconia alumina grain for sharpness and an exceptionally high cut rate; developed for low- to medium-pressure operations, especially on steel and steel castings; the most operator-friendly wheels
- ZI – zirconia alumina grain stays sharper, longer, making it the choice for iron castings: ZI/25 for tough metal removal, ZI/26 for finer surface finish
- NZC – zirconia alumina and silicon carbide blend is ideal for dirty, scale-covered castings

Better choice for strong performance to price ratio

## CHARGER ZIRCONIA ALUMINA

- Strong, free-cutting aluminum oxide abrasive for foundry snagging and stock removal
- These wheels have high-speed steel rings with fine centers and reinforcing webs for added safety
- Good, general-purpose choice for heavy-duty stock removal on low- to medium-horsepower machines

Good choice for numerous small jobs

## 5ZF ZIRCONIA ALUMINA AND GEMINI ALUMINUM OXIDE

- These wheels have high-speed steel rings with fine centers and reinforcing webs for added safety
- Ideal for lower horsepower machines or low-pressure applications
- 5ZF - Versatile, good quality zirconia alumina abrasive for foundry snagging and stock removal
- Gemini – versatile aluminum oxide formulation works well with a variety of machines, horsepowers, and operations

SIZE (D x T x H)	MAX. RPM	TIER: BEST			BETTER		GOOD	
		STD. PKG.	SPEC.	PART #	SPEC.	PART #	SPEC.	PART #
<b>Type O1 Straight</b>								
24 x 3 x 12	1,990	1	4ZF1234-R5B38S	690831 <b>66310</b>			5ZF14-QS	690831 <b>66858</b>
HS Steel Rings with Fine Centers, S Webs	1,990	1					Gemini All Purp.	690831 <b>67173</b>
30 x 2 x 12	1,595	1	4NZ1634-Q5B38S	692104 <b>21412</b>	Charger <b>Free Cut</b>	692104 <b>21417</b>	5ZF14-R	692104 <b>67105</b>
HS Steel Rings with Fine Centers, S Webs	1,595	1	4ZF1434-R5B38S	692104 <b>66458</b>	Charger <b>Long Life</b>	692104 <b>21418</b>	Gemini All Purp.	692104 <b>17463</b>
	1,595	1	4ZF1634-Q5B38S	692104 <b>66460</b>				
	1,595	1	ZI/25-R	662531 <b>19636</b>				
	1,595	1	ZI/26-Q	662531 <b>19638</b>				
	1,595	1	NZC142-R5B38S	692104 <b>21414</b>				

For your safety: all floorstand and swingframe wheels have strong fine centers, steel rings and high-strength fiberglass reinforcement construction.

### TECH TIP

- Always ensure proper mounting of floorstand and swingframe wheels by mounting with arrow down as marked on wheel
- Always use safety guard
- Always run wheel for 1 minute before grinding
- For optimum performance, ensure adequate air pressure and air volume when using pneumatic machines
- Use constant surface foot per minute machines for highest efficiency
- Do not overdress the wheel face
- Avoid loading or glazing by changing the contact angle
- Use pressure assist whenever possible to obtain maximum cut rate



It is the user's responsibility to refer to and comply with ANSI B7.1

the brightest product solutions from  
**A TOTAL SPECTRUM OF INNOVATION**

For everything from heavy-to-medium stock removal, to fine finishing, to light blending and polishing, abrasive products are available in many shapes, abrasive grains, specialty coatings and backing configurations to meet many application needs.

### Coated Abrasives

A coated abrasive product is made up of three basic raw materials: an abrasive grain, the backing onto which the abrasive is applied, and an adhesive bond.

### Abrasive Types

#### Emery (6)

Emery is a dark gray, round-shaped grain which tends to polish rather than abrade a work surface.

- For polishing and cleaning metal only



#### Garnet (5)

Garnet is reddish brown in color. This natural abrasive is medium hard and relatively sharp, but not as durable as synthetic abrasives.

- For use on wood only
- Particularly good for soft woods such as pine
- Produces an excellent finish



#### Silicon Carbide (4)

Silicon carbide is the hardest and sharpest of the manufactured abrasives. Because of its extreme sharpness, this bluish-black abrasive grain permits fast stock removal and cool cut.

- Cast iron
- Non-ferrous metals, i.e. brass, aluminum and bronze
- Non-metallics, i.e. glass, rubber, plastic and stone
- Final finish on wood and stainless steel
- Abrasive planing particleboard



#### Light Brown Aluminum Oxide (2)

Light brown aluminum oxide is a tough, yet sharp synthetic abrasive characterized by cool cut, long life and the ability to break down under pressure, producing new cutting edges.

- Production wood sanding
- Non-ferrous metal finishing



#### Brown Aluminum Oxide (2, 7)

Brown aluminum oxide is a tough, durable, synthetic abrasive characterized by the long life and wear resistance of its cutting edges. It offers enormous penetrating strength, even at high speeds.

- Ferrous metals
- Aluminum
- Hardwood



#### Heat-treated Aluminum Oxide (2)

Heat-treated aluminum oxide is a tough but cool cutting abrasive which gives both long life and freeness of cut on a wide range of materials.

- Ferrous metals
- Wood sanding



#### Zirconia Alumina (8)

Zirconia alumina is an ultra-tough, synthetic abrasive which provides a free, cool cut for high stock removal applications. It is tougher and sharper than aluminum oxide. It has a micro-crystalline structure which allows for controlled breakdown and self-sharpening.

- Heavy-duty snagging and grinding of all ferrous and non-ferrous metals
- Abrasive planing of wood, plywood and particleboard
- Grinding fiberglass, rubber and plastics



#### Ceramic Alumina (9)

The sub-micron structure of ceramic alumina allows each grain to continually expose sharp cutting points, resulting in a cooler cutting action and an extended life.

- All ferrous/non-ferrous metals, carbon steel and exotic alloys

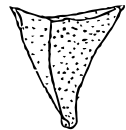

### Backing Types

Backings are the base for the abrasive minerals and, combined with the adhesive bond, support and anchor the abrasive mineral. The backings used in the manufacture of coated abrasives are:

#### Paper

Due to the fine surface of paper, a consistent finish is produced. Paper weights include *A, B, C, D, E* and *F* weights with *A* being the lightest and most flexible and *F* being the heaviest and least flexible. *A, B, C* and *D* weight papers are used for hand sanding and light mechanical operations in the form of sheets, PSA (pressure sensitive adhesive) and hook and loop discs and sheet rolls. *E* and *F* weight papers are primarily used for more aggressive mechanical operations in the form of belts and discs.

#### Cloth

Cloth backings used for coated abrasives are identified by weight. Cloth backings are filled or "finished" with a variety of materials (glues or resins) to create various backing characteristics, most notably flexibility. Several cloth types are used: cotton, polyester, polyester/nylon and polyester/cotton blends, and rayon.

There are three basic weights of cloth: J-weight or "jeans" is the lightest and most flexible. X-weight or "drills" is a heavier cloth that ranges in flexibility, strength and durability and is used on the broadest range of applications. Y-weight is a heavyweight drills cloth used on heavy-duty, high stock removal operations.

#### Fiber

Vulcanized fiber (cotton fibers which are chemically treated and then pressed under temperature and pressure to form a very durable backing) is used exclusively as the backing for resin fiber discs.

#### Film

Polyester film backing comes in 3 mil. and 5 mil. thicknesses, which have high strength and surface smoothness. They are used primarily in disc and roll applications requiring consistent surface finish, including powertrain applications.

#### Foam

Primarily used as backing for sponges, finer grit finishing discs, and buffing and polishing pads for cleaning and moist finishing applications.

#### Mesh

Mesh matrix backing comprised of thousands of tiny holes allowing for maximum dust extraction.

### Bond Types

An adhesive bond system is required to secure the abrasive mineral to the backing. All coated abrasive products are made with a two stage bonding process, the *make coat* and the *size coat*.

The *make coat* is the first layer of bond applied to the backing. The make coat provides the adhesive base between the abrasive mineral and the backing.

The *size coat* is the second coat, which is applied over the abrasive mineral and make coat to anchor the abrasive mineral and provide the desired physical strength of the finished product.

*Glue, urea resin, and phenolic resin* are the three basic bonding agents most commonly used. There are many size coat and make coat combinations, such as *glue over glue, urea over glue, and resin over resin*. *Glue over glue* is the most flexible bond while *resin over resin* bond is moisture-resistant, harder, less flexible, heat-resistant and has superior grain retention.

### Coating Types

There are two types of abrasive coatings used in the manufacturing of coated abrasives: *open coat* and *closed coat*.

#### Open Coat

With an open coat, 50% to 75% of the surface is covered by abrasive grain. There are evenly spaced voids between the particles of grain, helping reduce the effect of loading caused by wood dust or metal particles.



OPEN COAT  
(1/3 LESS GRAIN THAN CLOSED)

#### Closed Coat

With a closed coat, the entire surface is covered with abrasive grain, with no voids between the particles. This is the most typical coating, permitting the greatest degree of stock removal and longest product life.



CLOSED COAT

### Super Size Coating

The Super Size coat is an optional final coat and grinding aid applied over the size coat to help maintain low grinding temperatures and prevent loading.

### How to Read a Coated Abrasive Specification

The Norton coated abrasive marking system includes both a generic and a technical marking, which identifies the actual components which make up the product. The markings identify the tradename, abrasive type, bond, backing, and any special features. An example would be: Norton Blaze R980P.

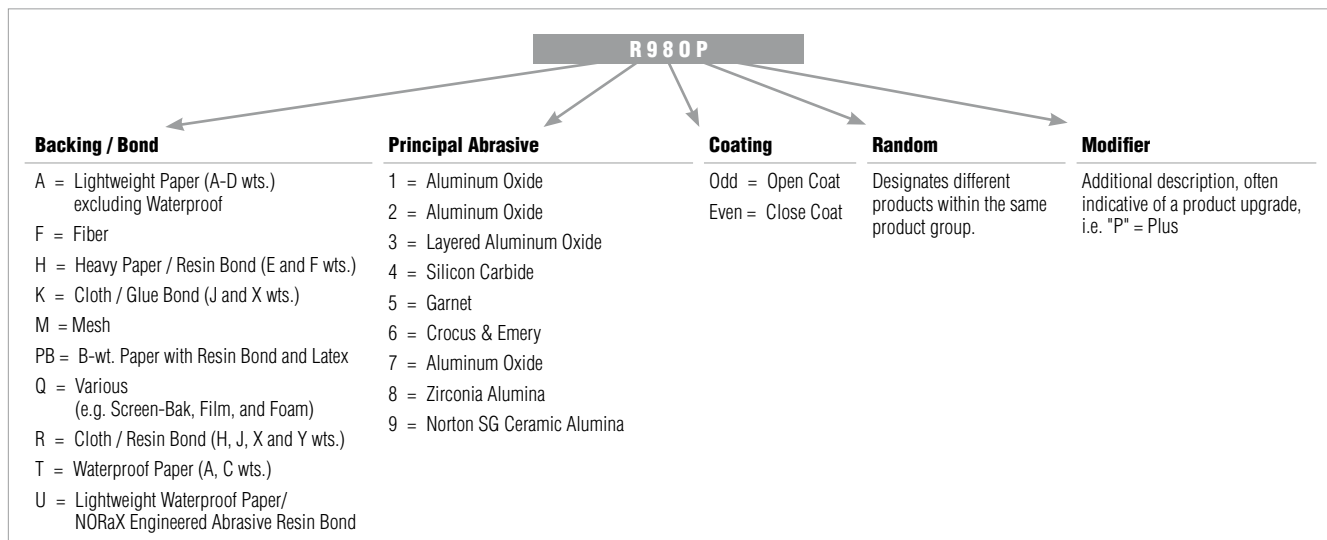

### Coated Abrasive Grit Comparison Chart

AVERAGE PARTICLE SIZE IN MICRONS	GRADING SYSTEMS (OTHER THAN EMERY)			EMERY PRODUCTS
	ANSI	FEPA	JIS	
5.0	-	-	-	-
6.0	-	-	3000	-
6.5	1200	-	2500	4/0
8.4	-	P2500	-	-
8.5	-	-	2000	-
9.2	1000	-	-	3/0
10.3	-	P2000	-	-
10.5	-	-	1500	-
12.2	800	-	1200	-
12.6	-	P1500	-	-
15.0	-	-	-	-
15.3	-	P1200	1000	-
16.0	600	-	-	2/0
18.3	-	P1000	800	-
19.7	500	-	-	0
20.0	-	-	-	-
21.8	-	P800	-	-
23.6	400	-	600	-
25.0	-	-	-	-
25.75	-	P600	-	-
28.8	360	-	500	-
30.0	-	P500	-	-
35.0	-	P400	400	-
36.0	320	-	-	-
40.0	-	-	360	-
40.5	-	P360	-	-
44.0	280	-	-	1
45.0	-	-	-	-
46.2	-	P320	320	-
50.0	-	-	-	-
52.5	-	P280	280	-
53.5	240	-	-	-
55.0	-	-	-	-
58.5	-	P240	-	-
60.0	-	-	240	-
64.0	-	-	-	2
65.0	-	P220	220	-
66.0	220	-	-	-
78.0	180	P180	180	-
79.0	-	-	-	3
93.0	150	-	150	-
95.0	-	-	-	FINE
97.0	-	P150	-	-
116.0	120	-	120	-
127.0	-	P120	100	-
136.0	-	-	-	MEDIUM
141.0	100	-	-	-
156.0	-	P100	-	-
189.0	-	-	-	COARSE
192.0	80	-	80	-
197.0	-	P80	-	-
260.0	-	P60	-	-
268.0	60	-	60	-
326.0	-	P50	50	-
341.0	-	-	-	EX. COARSE
351.0	50	-	-	-
412.0	-	P40	40	-
428.0	40	-	-	-
524.0	-	P36	-	-
535.0	36	-	36	-
622.0	-	P30	-	-
638.0	30	-	30	-
715.0	24	-	-	-
740.0	-	P24	24	-
905.0	20	-	-	-
984.0	-	P20	20	-
1320.0	16	-	16	-
1324.0	-	P16	-	-
1764.0	-	P12	-	-
1842.0	12	-	-	-

### Coated Abrasive Storage

Stored under proper conditions, coated abrasives will retain their efficiency and usefulness over long periods. Improper or inadequate storage can introduce problems of weakened bond, curl, brittleness, and breakage.

Temperature and humidity are the two most important climatic factors influencing coated abrasive performance. Backings and adhesives are sensitive to climatic changes and will gain or lose moisture according to the relative humidity of their surroundings.

Excessive humidity may cause a softening of some types of adhesive bonds so that the product quickly fills and clogs, or loses its grain during use. Excessive dryness may cause brittleness, reduced flexibility, and distortion of product shapes.

As moisture in the coated abrasive product increases or decreases, dimensional changes can occur. When the backing changes more than the adhesive bond, it causes cupping. High and low humidity can cause concave and convex cupping respectively.

The newer synthetic-backed belts are not affected by moisture. Broad temperature swings will not permanently harm these products either, but cold temperatures will cause a "cold set" condition. Consequently, these products should be allowed to come to room temperature before use.

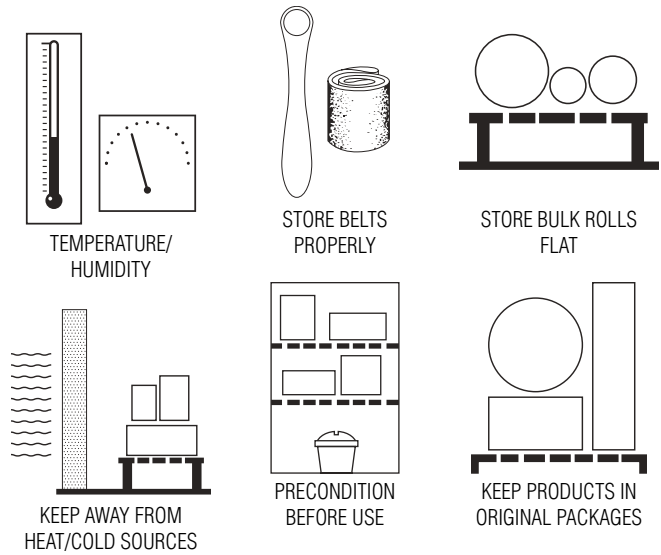

### Storage Facilities

The ideal storage (stock) room for coated abrasives would be one in which all the walls are inside partitions, rather than the outside walls of the building.

- Constant levels of humidity and temperature should be maintained. Stockroom temperature should be 60-degrees to 80-degrees F and relative humidity between 35 and 50%.
- Cartons should be kept away from damp or cold walls and floors, where they might absorb moisture.
- Store coated abrasives away from heat sources – steam heated radiators, steam pipes, hot air inlets, heat ducts, or rooms near furnaces or ovens.
- Keep products in original packages. These packages facilitate handling and can be stacked in the most practical and convenient manner.
- Bulk rolls should not be allowed to stand on edge after they have been unpacked. Store flat on shelves or pallets.
- Narrow belts which have been removed from the carton should be rolled up and stored on edge on a clean shelf. Belts may be draped over a large cylinder, such as a gallon can, brake drum, or flanged hanger of the type used for a garden hose. Never hang a belt from a nail – the backing will crease and the abrasive belt might crack. Wide belts should be hung over a tube of at least 4" diameter. Center the belt joint over the tube and add a light weight (such as old packaging tubes) to the bottom loop of the belt to aid in removing set. Condition for 24 hours prior to use.
- For maximum product efficiency, precondition coated abrasive products in a chamber of controlled temperature and humidity before use.

### Introduction

Most Norton Bear-Text products consist of a non-woven web of nylon fibers impregnated throughout with abrasive grain and bonded with synthetic resins. This design produces a cushioned, three-dimensional material that is extremely pliable and long lasting. The uniform dispersion of abrasive throughout the web provides a continuous supply of new grain as the old grain and fibers wear away during use.

Norton Bear-Text products, with their open mesh construction, are waterproof, washable, resilient, conformable, non-loading, non-conductive, non-metallic and non-rusting. Non-woven wheels are easily pre-formed to conform to special-shaped work pieces.

Since non-woven products are designed for use where stock removal is not required, they begin where other abrasives leave off. The relatively non-aggressive nature of nylon and grit inherent in the material makes it ideal as a finishing tool. While 60 to 80 grits are considered intermediate sizes in other products, they are considered coarse for non-woven items.

Used wet or dry, Norton Bear-Text non-woven products offer the following advantages: controlled cut (with little or no stock removal) allows for increased productivity, consistent, uniform finish, ability to automate operations, minimized smearing and reduced operator training. These advantages make our non-woven products an excellent alternative to bristle brushes, set-up wheels, greaseless compounds and steel wool.

### Product Identification System

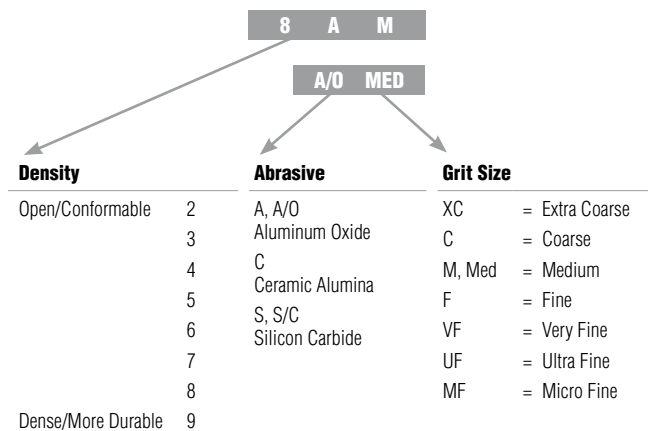

### Abrasives

Ceramic alumina, silicon carbide and aluminum oxide abrasives are offered. Ceramic alumina cuts the fastest and is the most cost effective on large-volume applications. Silicon carbide is sharper, cuts faster than aluminum oxide, and produces finer scratch patterns on most surfaces. Aluminum oxide is more durable and tends to last longer. It causes less discoloration on aluminum, and is more aggressive on certain applications such as hardened steel parts. Norton Bear-Text hand pads are also available in a non-abrasive material.

### Grits

Grit refers to the size of the abrasive grain impregnated into the nylon web. The coarser the grit, the more aggressive the cut, the rougher the finish. The finer the grit, the less aggressive the cut and the resulting surface finish will be finer, if all other conditions are equal.

GRIT DESIGNATIONS	GRIT SIZE
Extra Coarse (XC)	50
Coarse (C)	60 – 80
Medium (M)	100 – 150
Fine (F)	180 – 220
Very Fine (VF)	240 – 360
Super Fine (SF)	400
Ultra Fine (UF)	600
Micro Fine (MF)	800 – 1200

### Densities

The product “density” refers to the number of fibers which have been compressed into the nylon web material. Under identical conditions, harder density wheels cut faster, last longer and produce finer finishes than softer density wheels. Softer density wheels offer greater conformability and have less tendency to load or burn the work piece.

### Fiber Sizing

Several nylon fiber sizes are used in the manufacture of Norton Bear-Text and Merit web material because the fiber size is a significant factor in the coating process, as each produces distinct cutting characteristics.

### Bonding Agents

Waterproof resins are used in the manufacture of Norton Bear-Text and Merit web material to bond the nylon fibers together and to firmly anchor the abrasive grains throughout the web.

### Conventional Finishing Methods Versus Norton Bear-Text Non-Woven Products

The following chart outlines the advantages achievable when using our products as alternatives to other cleaning, blending, deburring and finishing methods. These products are listed in the sequence of normal preference for the application stated. However, because of the numerous variables, only testing can ensure selection of the most cost-effective product.

CONVENTIONAL FINISHING METHOD	KEY APPLICATION	NORTON/MERIT PRODUCT ALTERNATIVES	ADVANTAGES OF NORTON/MERIT PRODUCT VERSUS ALTERNATE FINISHING METHODS
Bristle Brushes	Cleaning	Rapid Strip, Convolute Wheels, and Rapid Prep Discs	Superior cleaning performance Higher productivity No slurry or compound required More consistent finish Eliminate compound dust
Greaseless Compounds	Finishing	Flap Wheels Convolute Wheels Unified Wheels Rapid Prep Discs	Reduced maintenance No compound, instant set-up Elimination of compound dust More uniform finish More consistent work rate
Set-up Wheels	Blending/ Deburring	Convolute Wheels Unified Wheels XHD Discs Rapid Prep Discs	No break-in time required More consistent cut More uniform finish Maintain geometry Safer, no flying wheel pieces
Steel Wool	Cleaning	Rolls Discs Hand Pads	Faster, longer life Less pressure required Non-rusting, cleaner Safer, no splinters



## Getting the Most Out of Norton Bear-Tex Wheels

Maximum wheel life and best surface conditioning results can be achieved by closely adhering to the following recommendations.

### 1) Wheel Direction

Convolute, interleaf flap wheels, and conventional flap wheels must always run in the direction indicated by the arrow printed on the side of each wheel. Unified wheels can be run in either direction.

### 2) Wheel Speed

Wheel speed is an important factor in that it affects product finish, rate of cut, and wheel life. In general, fast wheel speeds give harder action and a finer finish; whereas, slower speeds give a softer action and a coarser finish for the same wheel density.

The following are recommended operating speeds for the most common applications.

APPLICATION	RECOMMENDED SPEED
Cleaning and upgrading of surface conditions	2200 to 6000 SFPM
Cut-buffing on metal surfaces	6500 to 8000 SFPM
Deburring	5500 to 8000 SFPM
Decorative finishing	500 to 3000 SFPM
Imparting decorative finishes	900 to 3000 SFPM
Oxide removal	3500 to 6500 SFPM

*Testing might show that a slower or faster speed is desirable for specific operations. Never exceed the maximum RPM rating of the wheel.*

### 3) Pressure

Light to medium pressure is recommended for most operations. Flap wheels require much lighter pressure to perform properly than other non-woven wheels; unified wheels can withstand much higher pressures in order to perform deburring jobs. In all cases, avoid excessive pressure which might result in wheel deformation and damage to the work surface.

### 4) Feed Speed

Low feed speed reduces the number of workpieces completed, while producing a shorter scratch pattern. Slow feed speed allows for longer dwell time and permits more work to be done on each piece. Conversely, a fast feed speed increases the number of workpieces completed, while producing a longer scratch pattern.

### 5) Oscillation

Oscillation may be used to break up scratch lines and produce a more uniform finish. Additionally, an increase in cut might be experienced.

A general starting point for oscillation is 3/8" amplitude at 200 cycles per minute.

### 6) Lubricants

Lubricants, such as water, water soluble oil, and straight oil, will decrease the heat generated while running, improve the luster, and reduce the surface finish. The higher the viscosity of the lubricant, the lower the surface finish (RMS value) produced.

## Factors in Wheel Choice

This chart provides a relative comparison of other Norton Bear-Tex wheel variables. It can serve as a useful guide in choosing the most suitable product for a given application. However, as many other factors affect wheel performance, this chart can only be general in nature. The most cost-effective results can always be obtained by wheel testing on the application.

1 Wheel Conformability	MOST CONFORMABLE (SOFT)						LEAST CONFORMABLE (HARD)
	←	Flap Wheels	Clean & Finish	Metal Finishing	Rapid Finish GP 7 Density	Rapid Finish GP 8 & 9 Density	Series 4000
2 Wheel Openness	OPEN MESH						CLOSED MESH
	←		Clean & Finish	Metal Finishing	Rapid Finish GP 7 Density	Rapid Finish GP 8 & 9 Density	Series 4000
3 Wheel Aggressiveness	MOST AGGRESSIVE						LEAST AGGRESSIVE
	←		Metal Finishing		Clean & Finish	Rapid Finish GP	Flap Wheels
4 Finishing Action	COARSER						FINER
	←		Metal Finishing	Clean & Finish	Series 4000	Rapid Finish GP Series 4000	Flap Wheels
5 Pressure for Best Results	LIGHTER						HIGHER
	←	Flap Wheels	Clean & Finish	Metal Finishing Rapid Finish GP 7 Density		Rapid Finish GP 8 & 9 Density	Series 4000

\* On steel surfaces, silicon carbide wheels will produce a brighter finish than aluminum oxide wheels.

## Surface Finish Variables

Changes in any one of many factors can affect the surface finish on the work piece. This chart shows the effect on surface finish by changes in single factors of product specifications. Arrows have been used to signify the trend direction. The arrow length does not signify that the effect of each factor is equal.

Variable Factor	Rough Finish High RMS Reading	Smooth Surface Lower RMS Reading
1 Grit Size	Coarse ←	→ Very Fine
2 Wheel Grade	Soft ←	→ Hard
3 Wheel Speed	Slow ←	→ Fast
4 Feed Speed	Faster (Long Scratch) ←	→ Slower (Short Scratch)
5 Oscillation	No Oscillation ←	→ Oscillation
6 Lubricants and Compounds	Dry ←	→ Straight Oil
	← Water	→ Soluble Oil
	←	→ Compounds



The strongest of coated abrasive discs with resin-over-resin construction on heavy-duty fiber backing. Designed for applications ranging from heavy stock removal to surface blending. Used with back-up pads on portable angle grinders.

- Applications:** Stock removal, edge chamfering, weld blending, deburring/deflashing, rust removal, cleaning and finishing
- Size Range:** 4" x 5/8" hole, 4-1/2" – 9-1/8" x 7/8" and 5/8"-11 hole
- Grit Range:** 16 – 120
- Abrasive Grain:** Ceramic Alumina, Zirconia Alumina Blend, and Aluminum Oxide
- Product Options:** Conventional, Speed-Change hubs (5/8"-11), and AVOS technology
- Accessories:** Air-cooled, smooth-faced, and AVOS back-up pads
- Machines Used:**

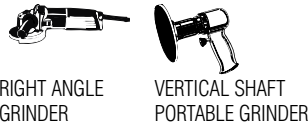

### Material-to-Product Recommendation Guide

	BEST		BETTER	GOOD	
	BlazeX F970	Blaze F980	BlueFire F826P	Gemini F726	Metal F240
Stainless Steel / Titanium / Super Alloys*		◆	◆	◆	◆
Mild Carbon Steel / Welds	◆		◆	◆	◆
Ferrous Metals / Cast Iron	◆		◆	◆	◆
Brass / Bronze / Aluminum				◆	◆

\*Nickel/Cobalt Based – Hastelloy, Inconel, Waspalloy



### Application/Grit Recommendation Guide

COARSER (GRINDING) ←										FINER (FINISHING) →									
16	24	30	36	40	50	60	80	100	120	16	24	30	36	40	50	60	80	100	120
Stock Removal				Edge Chamfering						Weld Blending									
Deburring/Deflashing						Rust Removal				Cleaning and Finishing									

### Cross Reference Guide

	TOTAL PERFORMANCE ←				INITIAL PRICE →	
	BEST		BETTER	GOOD		
NORTON	BlazeX F970	Blaze F980	BlueFire F826P	Gemini F726	Metal F240	
3M	782C, 982C, 988C	785C, 787C, 985C, 987C	501C	381C	—	
Camel	—	Ceramic	Zirconia	A/O	—	
Flexovit	CG	CG+	ZA	A	—	
GemTex	PMD, Gem Supreme	PMD Supreme, PMD Supreme Plus	Zee-Type, Zee Supreme, Gem Supreme	C-Type	A-Type	
Hermes	—	CR456	RB414X, RB414X Procut	RB514J	RB314	
Klingspor	FS964 ACT	FS966	CS565, CS570	FS764 ACT	CS561	
Metabo	CER	CER	ZA	—	A/O	
Mirka	—	—	Blue, Gold	—	Red	
Pearl	Red Line	—	FZ	Premium A/O	Silver Line	
Pferd	CO-PMD	CO Cool	Z, Z Cool	A Cool	A	
United Abrasives/Sait	7S, 7A-S, 7-11	9S, 9-11	3Z, Z, AZX	3A	A/O, 2A	
SIA	4515, 4580	4515, 4560,	4815, 4819	4924	4919, 4961	
Standard	Ceramic	Ceramic Pro	Zirconia	—	A/O	
VSM	XF760	AF890, AF799, XF885, XF870, XF850	ZF713, ZF714, ZF844	KF808	KF708	
Walter	Walter Coolcut XX	Walter Coolcut XX	Walter Topcut	Walter Coolcut	—	
Weiler	—	Tiger Ceramic	Tiger Zirc, Wolverine Zirc	Tiger A/O	Wolverine A/O	



Best choice for carbon steel and other soft-to-grind materials

## BLAZEX F970 CERAMIC ALUMINA

- Improved ceramic alumina micro-fracturing grain constantly exposes sharper grain edges to significantly increase cut rate and life over competitive blended/low-ratio ceramic alumina discs
- Heavier fiber backing for additional strength and tear resistance
- Non-supersized design for cool cutting and long life on carbon steel and other soft-to-grind materials



Best choice for stainless steel, titanium, and super alloys

## BLAZE F980 CERAMIC ALUMINA

- 100% ceramic alumina micro-fracturing grain constantly exposes sharper grain edges to significantly increase cut rate and life over competitive blended/low-ratio ceramic alumina discs
- Self-lubricating grinding aid treatment delivers the coolest cut on stainless steel, high alloy steels, super alloys, titanium, and other difficult to grind materials
- Heavier fiber backing for additional strength and tear resistance

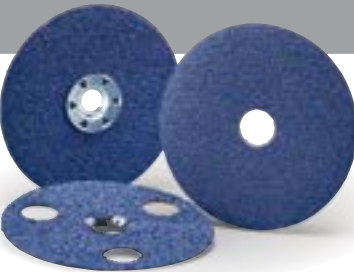

Better choice for stainless, super alloys, steel, cast iron and high-pressure applications

## BLUEFIRE F826P ZIRCONIA ALUMINA

- High-performance zirconia alumina abrasive blend provides 15% faster cut and longer life with less power draw than conventional zirconia discs
- Advanced resin bond technology with enhanced grain adhesion for extended life
- Heavier fiber backing for additional strength and tear resistance



Good choice for carbon steel and aluminum applications

## GEMINI F726 ALUMINUM OXIDE

- Premium aluminum oxide blend for aggressive cut and longer life than competitive aluminum oxide discs
- Full resin bond for strength and durability
- Heavier fiber backing for additional strength and tear resistance



Good choice for small jobs, applications where performance is not measured, and price-sensitive operations

## METAL F240 ALUMINUM OXIDE

- Versatile, multi-purpose aluminum oxide abrasive provides consistent performance on numerous materials and small jobs
- Full resin bond for strength and durability
- Heavier fiber backing for additional strength and tear resistance; low initial price



TIER:	BEST	BEST	BETTER	GOOD	GOOD
TRADENAME:	<b>BLAZEX F970</b>	<b>BLAZE F980</b>	<b>BLUEFIRE F826P</b>	<b>METAL F240</b>	<b>GEMINI F726</b>
ABRASIVE:	Ceramic Alumina	Ceramic Alumina	Zirconia Alumina Blend	Aluminum Oxide	Aluminum Oxide
OTHER:		Supersize			

SIZE (D x H)	GRIT	STD. PKG.	PART #	PART #	PART #	PART #	PART #
4 x 5/8	24	25				055395 <b>10595</b>	666233 <b>95000</b>
	36	25				055395 <b>10594</b>	666233 <b>95001</b>
	50	25					666233 <b>95002</b>
	60	25				055395 <b>10592</b>	
	80	25					666233 <b>95004</b>
4-1/2 x 7/8	24	25		699573 <b>98000</b>	662611 <b>38457</b>	666233 <b>53309</b>	666233 <b>95007</b>
	36	25	699573 <b>70193</b>	699573 <b>98001</b>	662611 <b>38456</b>	666233 <b>53306</b>	666233 <b>95008</b>
	36	50 V			666233 <b>77276</b>		
	50	25	699573 <b>70194</b>	699573 <b>98002</b>	662611 <b>38454</b>	666233 <b>53310</b>	666233 <b>95009</b>
	60	25	699573 <b>70195</b>	699573 <b>98003</b>	662611 <b>38453</b>	666233 <b>53311</b>	666233 <b>95010</b>
	60	50 V			666233 <b>77278</b>		
	80	25	699573 <b>70196</b>	699573 <b>98004</b>	662611 <b>38452</b>	666233 <b>53312</b>	666233 <b>95011</b>
	80	50 V			666233 <b>77279</b>		
	100	25				666233 <b>53313</b>	666233 <b>95012</b>
	120	25		662544 <b>25332</b>		666233 <b>53314</b>	666233 <b>95013</b>
5 x 7/8	16	25				055395 <b>10684</b>	
	24	25		699573 <b>98005</b>	662611 <b>38563</b>	666233 <b>57276</b>	666233 <b>95016</b>
	36	25	699573 <b>70197</b>	699573 <b>98006</b>	662611 <b>38562</b>	666233 <b>57277</b>	666233 <b>95017</b>
	36	50 V			666233 <b>77283</b>		
	50	25	699573 <b>70198</b>	699573 <b>98007</b>	662611 <b>38561</b>	666233 <b>57278</b>	666233 <b>95018</b>
	60	25	699573 <b>70199</b>	699573 <b>98008</b>	662611 <b>38601</b>	666233 <b>57279</b>	666233 <b>95019</b>
	80	25	699573 <b>70200</b>	699573 <b>98009</b>	662611 <b>38600</b>	666233 <b>57280</b>	666233 <b>95020</b>
	100	25				666233 <b>57281</b>	666233 <b>95021</b>
	120	25		662544 <b>09084</b>		666233 <b>57282</b>	666233 <b>95022</b>
	24	25		662611 <b>60033</b>			
6 x 7/8	36	25		662611 <b>60034</b>			
	50	25		662611 <b>60035</b>			
	80	25		662611 <b>60037</b>			
	16	25				055395 <b>10693</b>	
	24	25		699573 <b>98010</b>	662611 <b>38594</b>	666233 <b>57283</b>	666233 <b>95029</b>
7 x 7/8	36	25	699573 <b>70201</b>	699573 <b>98011</b>	662611 <b>38593</b>	666233 <b>57284</b>	666233 <b>95030</b>
	36	50 V			666233 <b>77287</b>		
	50	25	699573 <b>70202</b>	699573 <b>98012</b>	662611 <b>38592</b>	666233 <b>57285</b>	666233 <b>95031</b>
	60	25	699573 <b>70203</b>	699573 <b>98013</b>	662611 <b>38591</b>	666233 <b>57286</b>	666233 <b>95032</b>
	80	25	699573 <b>70204</b>	699573 <b>98014</b>	662611 <b>38590</b>	666233 <b>57287</b>	666233 <b>95033</b>
	100	25				666233 <b>57288</b>	666233 <b>95034</b>
	120	25		662544 <b>11528</b>		666233 <b>57289</b>	666233 <b>95035</b>
	24	25		699573 <b>98015</b>	662611 <b>38584</b>	055395 <b>10702</b>	666233 <b>95036</b>
	36	25		699573 <b>98016</b>	662611 <b>38583</b>	055395 <b>10701</b>	666233 <b>95037</b>
	50	25		699573 <b>98017</b>	662611 <b>38582</b>		666233 <b>95038</b>
9-1/8 x 7/8	60	25				055395 <b>10699</b>	666233 <b>95039</b>
	80	25					666233 <b>95040</b>
	100	25					666233 <b>95041</b>
	120	25					666233 <b>95042</b>

Note: Fiber discs must be used with back-up pads shown on the last page of this section.

V = Vendible Package. Ideal for vending machines and small jobs. 10 discs/package, 5 packages per standard carton. Order in multiples of 50.



Learn the best way to mount a fiber disc on a right angle grinder at <https://nortonsga.us/5sdjv>

### Speed-Change Fiber Discs

These fiber discs feature Norton quick, tool-free, twist-on and -off Speed-Change fasteners. Discs lock to standard back-up pads with a unique nut design and are easily removed, increasing your productivity with more time to grind.



		BEST		BEST		BETTER		GOOD	
		BLAZEX F970		BLAZEX F980		BLUEFIRE F826P		GEMINI F726	
		Ceramic Alumina		Ceramic Alumina		Zirconia Alumina Blend		Aluminum Oxide	
		OTHER:		Supersize					
SIZE (D x H)	GRIT	STD. PKG.	PART #	PART #	PART #	PART #	PART #	PART #	PART #
4-1/2 x 5/8-11	24	25		66261023269			77696009702		
	36	25	69957370205	66261185294			77696009703		
	50	25	69957370206				77696009704		
	60	25	69957370207	66261042247					
	80	25	69957370208	66623328529				77696009715	
5 x 5/8-11	24	25		66254425336	66261138797				77696009723
	36	25	69957370209	66261185801	66261138796		66623395014		
	50	25	69957370210						
	60	25	69957370211	66261185803			66623395015		
	80	25	69957370212	66623316697			77696009728		
7 x 5/8-11	24	25		69957349782	66261138819		66623395023		
	36	25	69957370213	66261029863	66261138818		66623395024		
	50	25	69957370214			66261138817	66623395025		
	60	25	69957370215	66261042249	66261138816				
	80	25	69957370216	66254474373			66623395026		
	100	25					66623395027		
	120	25					66623395028		

Note: Speed Change fiber discs must always be used with smooth face back-up pads, see next page for details.

### Blaze Fiber Disc Test Kits NEW

- Each kit contains one box of 25 BlazeX F970 (36 grit) fiber discs and one box of 25 Blaze F980 (36 grit) fiber discs. Test them for yourself!



TIER: **BEST**  
 TRADENAME: **BLAZEX F970 & BLAZE F980 TEST KITS**  
 ABRASIVE: Ceramic Alumina

SIZE	GRIT	STD. PKG.	PART #
4-1/2	36	1	77696095018
5	36	1	77696095019
7	36	1	77696095020

### AVOS Fiber Discs

- Patented, see-through design allows interrupted cut which reduces heat up to 30% over standard discs
- The scooped holes create air flow to pull swarf away from grinding zone; cool cutting and extended product life
- 15° back-up pad for full utilization of discs – no gouging
- Quick, tool-free, twist-on and -off Speed-Lok fasteners



TIER: **BEST**      **BETTER**  
 BRAND: Norton      Norton  
 TRADENAME: **BLAZE F980**      **BLUEFIRE F826P**  
 ABRASIVE: Ceramic Alumina      Zirconia Alumina Blend

SIZE	GRIT	STD. PKG.	PART #	PART #
4-1/2 Speed-Lok (3 hole)	24	10	66254468389	66261129718
	36	10	66254468390	66261129719
	50	10	66254468391	66261129720
	60	10	66254468392	66261129721
	80	10	66254468393	66261129722
5 Speed-Lok (3 hole)	24	10	66254468385	66261126556
	36	10	66254468386	66261126557
	50	10	66254468387	66261126558
	60	10	66254468388	66261126559
7 Speed-Lok (6 hole)	24	10	66254468381	66261137454
	36	10	66254468382	66261137455
	50	10	66254468383	66261137456
	60	10	66254468384	
	80	10		66261137458

Note: AVOS fiber discs must be used with AVOS Speed-Lok back-up pads, see next page for details.



## Fiber Disc Accessories



### Fiber Disc Baling Unit

- Places 100 discs on a spindle between two plates
- Locks down with a pinch screw
- Maintains the shape of the discs by maintaining pressure to minimize curl
- User-friendly and reusable



### Air-Cooled Standard Back-up Pad

Slotted hub design and curved ribs draw heat away from the grinding zone, reducing disc loading and increasing life. All pads have a 5/8"-11 threaded female hub for mounting. We also offer a no-nose pad for shorter-shafted right angle grinders.



### Smooth Face Speed-Change Back-up Pad

Molded rubber back-up pads with a smooth face.

- Hard density pads are for aggressive cutting action
- Medium density pads are for all-purpose applications



### AVOS Fiber Disc Back-up Pad

- Patented, see-through design allows interrupted cut which reduces heat up to 30% over standard discs
- The scooped holes create air flow to pull swarf away from grinding zone
- 15° back-up pad for full utilization of discs – no gouging
- Quick, tool-free, twist-on and -off Speed-Lok fasteners

DESCRIPTION	MAX. RPM	STD. PKG.	PART #
<b>Fiber Disc Baling Unit</b>			
5"	—	1	776960 <b>01065</b>
7"	—	1	776960 <b>01066</b>
<b>Rubber Back-up Pads</b>			
<b>Air-Cooled Standard for 7/8 Hole Fiber and Non-Woven Discs</b>			
4" Medium	12,000	5	636425 <b>04918</b>
4-1/2" Medium	11,000	5	636425 <b>02122</b>
5" Medium	10,000	5	636425 <b>43421</b>
7" Hard	8,600	5	636425 <b>43425</b>
7" Medium	8,600	5	636425 <b>43422</b>
9" Hard	6,600	5	636425 <b>43426</b>
9" Medium	6,600	5	636425 <b>43423</b>
<i>Note: Retainer nuts are not included with back-up pads. These must be ordered separately.</i>			
<b>Air-Cooled No-Nose</b>			
4-1/2" Medium	11,000	5	636425 <b>04872</b>
5" Medium	10,000	5	636425 <b>03000</b>
<b>Smooth Face for Fiber and Non-Woven Speed-Change Discs</b>			
4-1/2" Medium	20,000	5	662544 <b>92277</b>
5" Medium	12,000	5	636425 <b>43235</b>
7" Hard	8,600	5	636425 <b>43240</b>
7" Medium	8,600	5	636425 <b>43245</b>
7" Soft	8,600	5	636425 <b>43250</b>
9" Medium	7,000	5	636425 <b>43270</b>
<b>AVOS Speed-Lok Back-up Pads</b>			
<b>AVOS Triangular Speed-Lok Back-up Pads</b>			
4-1/2" x 5/8-11	13,000	5	636425 <b>02985</b>
5" x 3/8-24 Pistol Grip*	20,000	5	636425 <b>03029</b>
5" x 5/8-11	13,000	5	636425 <b>02517</b>
5" x 5/8-11 Thicker	13,000	5	636425 <b>03663</b>
5" x 7/16-20 Pistol Grip*	20,000	5	636425 <b>03030</b>
<i>*Use on air pneumatic and high-speed pistol grip sanders</i>			
<b>AVOS Round Speed-Lok Back-up Pads</b>			
7" x 5/8-11 Hard	8,600	5	636425 <b>04873</b>
<b>Tools</b>			
#103 Retainer Nut	—	10	636425 <b>43463</b>
Spanner Wrench	—	5	636425 <b>43005</b>
66NS Short Retainer Nut	—	10	636425 <b>43461</b>

All fiber disc back-up pads are packed in individual boxes within the shipping carton. Each box can be used in a vending machine.



### Corner Store Convenience – Right on the Floor

Industry's best selection of vendible abrasive solutions

See the many popular products conveniently pre-packed in small quantity packages

- Perfect for vending machines, pegboards, new test orders, small orders and jobs, and carrying cleanly to job site
- Available in fiber, flap, paper, and quick-change discs, belts, hand pads, depressed center, cut-off and bench wheels, mounted points, cones and plugs, and sharpening stones



Flap discs are versatile grinding and finishing tools having four main components: abrasive flaps, flap density (how the flaps are stacked), backing plate shape (flat or conical), backing plate material (fiberglass or plastic). All flap discs have flaps that are overlapped and glued to the backing plate. The flaps wear during use, exposing new abrasive grain. The different variations of the components above provide a variety of application choices ranging from heavy stock removal to blending to finishing. Flap discs are designed for portable grinder applications and can be the preferred choice over depressed center wheels or fiber discs.

- Applications:** Grinding, stock removal, edge chamfering/beveling, weld blending, deburring/deflashing, rust removal, blending, cleaning and finishing
- Size Range:** 4" : 5/8" hole  
4-1/2" - 7" : 5/8"-11 discard mount, 7/8" hole, and 2" - 3" quick-change
- Grit Range:** 24 - 120
- Abrasive Grain:** Ceramic Alumina, Zirconia Alumina, and Aluminum Oxide
- Abrasive Flaps:** Polyester, Cotton/Poly Blend
- Flap Disc Shape:** Type 27 Flat and Type 29 Conical
- Abrasive Flap Density:** Standard or high
- Backing Plate Material:** Fiberglass and plastic
- Machine Used:** RIGHT ANGLE GRINDER

## Flap Disc Shapes

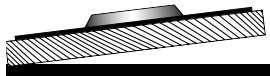

GRIND AT FLATTER ANGLES:  
**0° - 15°**

### Type 27 Flat – The Best Choice for Finishing

- Used primarily on flat surfaces
- The best choice for blending and smooth finishing

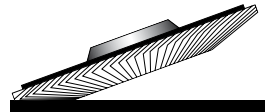

GRIND AT STEEPER ANGLES:  
**15° - 25°**

### Type 29 Conical – The Best Choice for Aggressive Stock Removal

- Conical flap discs have angled flaps and may be used on both contoured and edge work
- The angle provides greater surface contact for stock removal on flat surfaces
- The best choice when speed and stock removal are primary considerations

## Abrasive Flap Densities



### Standard Density

- Excellent for heavy-duty applications and rapid stock removal



### High Density

- Ideal when working on uneven or curved surfaces, as well as finer grit blending

## Backing Plate Materials

All flap discs are a combination of abrasive flaps adhered to a rigid backing plate. It is the backing plate that provides stability during operation. There are two main materials used: fiberglass and plastic. The fiberglass backing plate, along with the flap shape, helps to absorb vibration and is consumed during use with no smearing. Fiberglass is the most popular material because of its high strength and light weight. The plastic backing plate offers some additional conformability and is trimmable.

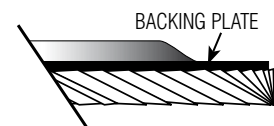

## Why Choose Flap Discs?

Flap discs replace both grinding wheels and fiber discs. The same flap disc can be used for applications ranging from stock removal to blending.

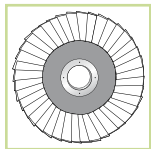

### Flap Discs vs. Grinding Wheels

- Faster stock removal
- Smoother finish, no gouging
- Cooler cutting, less glazing
- Lightweight, easier to control
- Less vibration, less operator fatigue
- Reduced noise

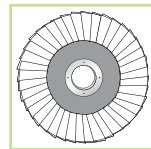

### Flap Discs vs. Fiber Discs

- 20X longer life, reduced abrasive cost
- Fewer disc changes, reduced labor cost
- More consistent finish
- No back-up pad required
- Easier storage, no curling
- Reduced loading
- Use flap discs one grit size coarser than fiber discs, except in 36 grit

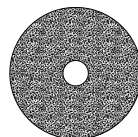

### Material-to-Product Recommendation Guide

	BEST Blaze R980P	BETTER BlueFire R884P	GOOD Gemini R766	Metal R828
<b>TYPE 29 FOR STOCK REMOVAL</b>				
Stainless Steel / Titanium / Super Alloys	◆	◆	◆	◆
Mild Carbon Steel / Welds		◆	◆	◆
Ferrous Metals / Cast Iron		◆	◆	◆
Brass / Bronze / Aluminum		◆		
<b>TYPE 27 FOR BLENDING AND FINISHING</b>				
Stainless Steel / Titanium / Super Alloys	◆	◆	◆	◆
Mild Carbon Steel / Welds		◆	◆	◆
Ferrous Metals / Cast Iron		◆	◆	◆
Brass / Bronze / Aluminum		◆	◆	◆

### Application/Grit Recommendation Guide

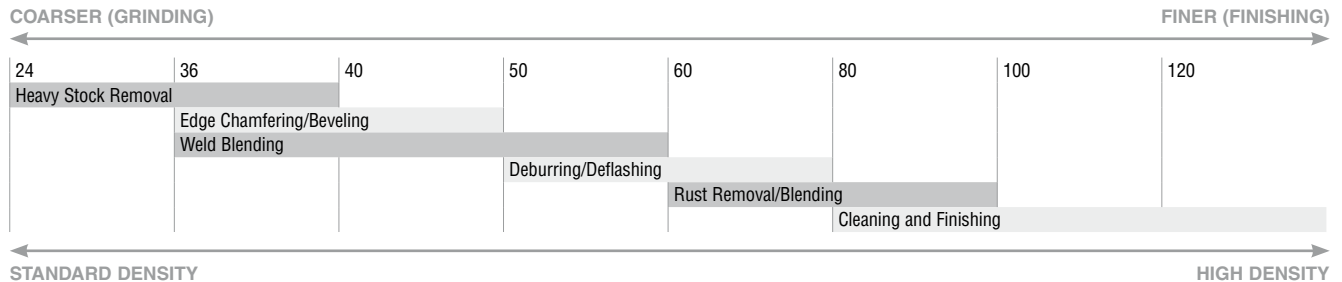

### Cross Reference Guide

	TOTAL PERFORMANCE ← →		INITIAL PRICE ← →	
	BEST	BETTER	GOOD	
NORTON	Blaze R980P	BlueFire R884P	Gemini R766	Metal R828
3M	747D, 947D, 967A, 969F	546D, 566A, 577F	—	—
Camel	Ceramic Pro	ZA Pro	A Pro	ZA
CGW/Pasco	Ceramic	Zirconia	A/O	—
DeWalt	XP Ceramic	HP Zirconia	Zirconia	FlexVolt
Flexovit	Zircotex Ceramic	Zircotex, Zirocomax, Tornado	—	—
Garryson	CeramiQ	Zirc+	Zirconium	A/O
GemTex	Ceramic Flaptec	Zirconia Flaptec	A/O Flaptec	—
Hermes	—	FL390	RB48024YX, RB48624YX	Webrax-AN 701
Klingspor	SMT656	SMT624, SMT626, SMT627, SMT630	SMT627	—
Metabo	Flexiamant Super Ceramic	Flexiamant Zirconia, Novoflex	—	—
Mirka	—	—	Blue	—
Pearl	Redline Maxidics, Stainlessmax Maxidics	Zirconia Maxidisc, Silver Line Zirconia	A/O Maxidisc	Silver Line A/O
Pferd	Polifan Z-SG, Polifan SG-CO	Polifan SG Zirkon, Polifan SG ZA, SGP, PSF Zirc	Polifan SG A, A-Cool	Polifan PSF A/O
United Abrasives/Sait	Encore Ceramic, Ovation Ceramic	Ovation, Saitlam U	Ovation Attacker	Encore
SIA	—	—	2824 SIAFlap	—
Standard	Ceramic Pro, Ceramic	Zirconia HP, Zirconia AP	Zirconia GP	—
Tyrolit	Cerabond Ceramic, Premium Ceramic	Fastcut, Premium Longlife	Premium A/O	Basic, Standard
VSM (Lehigh Valley)	Ceramic	Zirconia	A/O	—
Walter	Enduro-Flex Turbo	Enduro-Flex, Enduro-Flex Stainless	Enduro-Flex Alu.	Flexsteel
Weiler	Tiger Ceramic, Tiger X, Tiger Saber Tooth	Tiger Paw, Wolverine	Tiger Premium	Tiger



Best/highest productivity for stainless steel, titanium, and super alloys



## BLAZE R980P CERAMIC ALUMINA

- Premium ceramic alumina abrasive grain lasts 50% – 200% longer than many flap discs on stainless steel, cobalt, chrome, inconel, titanium and other hard-to-grind materials
- Y-weight polyester flaps with a supersize grinding aid significantly improve life, grain retention, and fray resistance while providing a cool, noticeably fast cut rate
- High-strength fiberglass back on Type 29 and Type 27 High Density is durable, lightweight, and absorbs vibration; Black, flexible plastic backing plate on Type 27 Quick Trim allows for trimmability of the plate

Better choice for mild carbon steel, and welds



## BLUEFIRE R884P ZIRCONIA ALUMINA

- High performance zirconia alumina plus abrasive for aggressive cut and long life, with up to 30% longer life than competitive zirconia alumina products
- Polyester/cotton flaps with semi-open coat provide improved durability and reduces loading on aluminum
- High-strength fiberglass back on Type 29 and Type 27 High Density is durable, lightweight, and absorbs vibration; blue, flexible plastic backing plate on Type 27 Quick Trim allows for trimmability of the plate
- Vendible 2-disc package is ideal for vending machines, small jobs, or carrying to a job site

Good choice for carbon steel and aluminum applications



## GEMINI R766 ALUMINUM OXIDE

- Alternating zirconia alumina and aluminum oxide flaps provide higher performance than aluminum oxide while retaining an economical price
- Polyester/cotton flaps are the best choice when speed of job completion and stock removal are primary considerations
- Type 27 Flat with quick trim, flexible plastic backing plate or high-density fiberglass back; Type 29 conical with durable, fiberglass back

Good consistent performance with low initial price



## METAL R828 ZIRCONIA ALUMINA

- Durable zirconia grain provide good cut rate and life with consistent finish
- Fiberglass/resin backing plates with high strength, light weight, ability to absorb vibration, and operator comfort
- Good choice for coarse grit blending, deburring, and stock removal



TIER:	BEST	BETTER	GOOD	GOOD	GOOD
TRADENAME:	<b>BLAZE R980P</b>	<b>BLUEFIRE R884P</b>	<b>GEMINI R766</b>	<b>METAL R828</b>	<b>METAL R828</b>
SHAPE:	Type 29 Conical	Type 29 Conical	Type 29 Conical	Type 29 Conical	Type 29 Conical
FLAP DENSITY:	Standard	Standard	Standard	Standard	High
ABRASIVE:	Ceramic Alumina	Zirconia Alumina Plus	Aluminum Oxide	Zirconia Alumina	Zirconia Alumina
BACKING PLATE:	Fiberglass	Fiberglass	Fiberglass	Fiberglass	Fiberglass
OTHER:	Supersize				

SIZE (D x H)	GRIT	MAX. RPM	STD. PKG.	PART #	PART #	PART #	PART #	PART #
<b>Type 29 Conical</b>								
4 x 5/8	36	15,300	10		666233 <b>99049</b>			
	40	15,300	10		666233 <b>99050</b>			
	60	15,300	10		666233 <b>99051</b>			
	80	15,300	10		666233 <b>99052</b>			
4-1/2 x 5/8-11	36	13,300	10	662611 <b>83490</b>	662544 <b>61165</b>	666233 <b>99028</b>	662544 <b>19991</b>	
	36	13,300	10 V		666233 <b>41104</b> 2-Pack			
	40	13,300	10	662611 <b>83491</b>	662544 <b>61167</b>	666233 <b>99029</b>	662544 <b>19994</b>	662611 <b>32535</b>
	60	13,300	10	662611 <b>83492</b>	662544 <b>61170</b>	666233 <b>99030</b>	662544 <b>19996</b>	662611 <b>32536</b>
	60	13,300	10 V		666233 <b>41105</b> 2-Pack			
	80	13,300	10	662611 <b>83493</b>	662544 <b>61173</b>	666233 <b>99173</b>	662544 <b>19997</b>	662611 <b>32537</b>
	80	13,300	10 V		666233 <b>41106</b> 2-Pack			
	120	13,300	10			666233 <b>99174</b>		
4-1/2 x 7/8	24	13,300	10		666233 <b>99204</b>			
	36	13,300	10	662611 <b>83486</b>	662544 <b>61155</b>	666233 <b>99032</b>	662544 <b>19963</b>	
	36	13,300	10 V		666233 <b>41107</b> 2-Pack			
	40	13,300	10	662611 <b>83487</b>	662544 <b>61161</b>	666233 <b>99033</b>	662544 <b>19978</b>	662611 <b>32538</b>
	60	13,300	10	662611 <b>83488</b>	662544 <b>61163</b>	666233 <b>99034</b>	662544 <b>19984</b>	662611 <b>32539</b>
	60	13,300	10 V		666233 <b>41108</b> 2-Pack			
	80	13,300	10	662611 <b>83489</b>	662544 <b>61164</b>	666233 <b>99035</b>	662544 <b>19987</b>	662611 <b>32540</b>
	80	13,300	10 V		666233 <b>41109</b> 2-Pack			
5 x 5/8-11	36	12,000	10		666233 <b>99189</b>			
	40	12,000	10		666233 <b>99190</b>			
	60	12,000	10		666233 <b>99191</b>			
	80	12,000	10		666233 <b>99192</b>	666233 <b>99179</b>		
	120	12,000	10			666233 <b>99180</b>		
5 x 7/8	24	12,000	10		666233 <b>99206</b>			
	36	12,000	10	662611 <b>90001</b>	662544 <b>61174</b>	666233 <b>99036</b>	662544 <b>19998</b>	
	40	12,000	10	662611 <b>90002</b>	662544 <b>61176</b>	666233 <b>99037</b>	662544 <b>20001</b>	
	60	12,000	10	662611 <b>90003</b>	662544 <b>61177</b>	666233 <b>99038</b>	662544 <b>20002</b>	
	80	12,000	10	662611 <b>90004</b>	662544 <b>61178</b>	666233 <b>99039</b>	662544 <b>20003</b>	
	120	12,000	10			666233 <b>99181</b>		
	6 x 5/8-11	40	10,200	10		666233 <b>99040</b>	662544 <b>91779</b>	
	60	10,200	10		666233 <b>99041</b>	662544 <b>91780</b>		
	80	10,200	10		666233 <b>99042</b>	662544 <b>91781</b>		
6 x 7/8	24	10,200	10		666233 <b>99066</b>			
	36	10,200	10		666233 <b>99298</b>			
	40	10,200	10		666233 <b>99193</b>	666233 <b>99182</b>	662544 <b>91776</b>	
	60	10,200	10		666233 <b>99194</b>	666233 <b>99183</b>	662544 <b>91777</b>	
	80	10,200	10		666233 <b>99195</b>	666233 <b>99184</b>	662544 <b>91778</b>	
7 x 5/8-11	36	8,600	10	662611 <b>83498</b>	662544 <b>61188</b>	666233 <b>99185</b>	662544 <b>20009</b>	
	40	8,600	10	662611 <b>83499</b>	662544 <b>61190</b>	666233 <b>99043</b>	662544 <b>20010</b>	
	60	8,600	10	662611 <b>83500</b>	662544 <b>61192</b>	666233 <b>99044</b>	662544 <b>20012</b>	
	80	8,600	10	662611 <b>83501</b>	662544 <b>61193</b>	666233 <b>99045</b>	662544 <b>20013</b>	
	120	8,600	10			666233 <b>99186</b>		
7 x 7/8	24	8,600	10		666233 <b>99196</b>			
	36	8,600	10	662611 <b>83494</b>	662544 <b>61180</b>		662544 <b>20004</b>	
	40	8,600	10	662611 <b>83495</b>	662544 <b>61183</b>	666233 <b>99046</b>	662544 <b>20006</b>	
	60	8,600	10	662611 <b>83496</b>	662544 <b>61185</b>		662544 <b>20007</b>	
80	8,600	10	662611 <b>83497</b>	662544 <b>61186</b>				

V = Vendible package. 2 discs/pack; 5 packs/carton. Order in multiples of 10.

See Portable Tools and Specialties section for mini flap discs.



TIER:	<b>BEST</b>	<b>BEST</b>	<b>BETTER</b>	<b>BETTER</b>	<b>GOOD</b>	<b>GOOD</b>	<b>GOOD</b>
TRADENAME:	<b>BLAZE R980P</b>	<b>BLAZE R980P</b>	<b>BLUEFIRE R884P</b>	<b>BLUEFIRE R884P</b>	<b>GEMINI R766</b>	<b>GEMINI R766</b>	<b>METAL R828</b>
SHAPE:	Type 27 Flat	Type 27 Flat	Type 27 Flat	Type 27 Flat	Type 27 Flat	Type 27 Flat	Type 27 Flat
FLAP DENSITY:	Standard	High	Standard	High	Standard	Standard	Standard
ABRASIVE:	Ceramic Alumina	Ceramic Alumina	Zirconia Alumina Plus	Zirconia Alumina Plus	Aluminum Oxide	Aluminum Oxide	Zirconia Alumina
BACKING PLATE:	Quick Trim Plastic	Fiberglass	Quick Trim Plastic	Fiberglass	Quick Trim Plastic	Fiberglass	Fiberglass
OTHER:	Supersize	Supersize					

SIZE (D x H)	GRIT	MAX. RPM	STD. PKG.	PART #	PART #	PART #	PART #	PART #	PART #	
<b>Type 27 Flat</b>										
4-1/2 x 5/8-11	36	13,300	10		662544 <b>99894</b>	666233 <b>99136</b>		666233 <b>99125</b>	666233 <b>99205</b>	662544 <b>72655</b>
	36	13,300	10 V			666233 <b>41086</b>	2-Pk			
	40	13,300	10	662544 <b>00257</b>	662610 <b>98290</b>	666233 <b>99137</b>	776960 <b>90086</b>	666233 <b>99000</b>	666233 <b>99059</b>	662544 <b>37013</b>
	60	13,300	10	662544 <b>00258</b>	662610 <b>96435</b>	666233 <b>99138</b>	776960 <b>90087</b>	666233 <b>99001</b>	666233 <b>99060</b>	662544 <b>72656</b>
	60	13,300	10 V			666233 <b>41087</b>	2-Pk			
	80	13,300	10	662544 <b>00259</b>	662610 <b>96436</b>	666233 <b>99139</b>	776960 <b>90088</b>	666233 <b>99002</b>	666233 <b>99061</b>	662544 <b>72657</b>
4-1/2 x 7/8	120	13,300	10	662544 <b>00261</b>				666233 <b>99003</b>		
	36	13,300	10	636425 <b>01865</b>	662610 <b>97678</b>	666233 <b>99140</b>	776960 <b>90081</b>	666233 <b>99126</b>	666233 <b>99062</b>	662544 <b>72653</b>
	40	13,300	10	662544 <b>00253</b>	662610 <b>20628</b>	666233 <b>99141</b>	776960 <b>90082</b>	666233 <b>99004</b>	666233 <b>99063</b>	662544 <b>37004</b>
	60	13,300	10	662544 <b>00254</b>	662610 <b>20633</b>	666233 <b>99142</b>	776960 <b>90083</b>	666233 <b>99005</b>	666233 <b>99064</b>	662544 <b>48989</b>
	80	13,300	10	662544 <b>00255</b>	662610 <b>20634</b>	666233 <b>99143</b>	776960 <b>90084</b>	666233 <b>99006</b>	666233 <b>99065</b>	662544 <b>48990</b>
	120	13,300	10	662544 <b>00256</b>			776960 <b>90085</b>	666233 <b>99007</b>		
5 x 5/8-11	36	12,000	10			666233 <b>99144</b>		666233 <b>99127</b>		
	40	12,000	10	776960 <b>90141</b>		666233 <b>99145</b>		666233 <b>99128</b>	666233 <b>99208</b>	
	60	12,000	10	776960 <b>90142</b>		666233 <b>99146</b>		666233 <b>99130</b>	666233 <b>99209</b>	
	80	12,000	10	776960 <b>90143</b>		666233 <b>99147</b>		666233 <b>99131</b>	666233 <b>99210</b>	
	120	12,000	10					666233 <b>99132</b>		
5 x 7/8	36	12,000	10			666233 <b>99148</b>		666233 <b>99133</b>	666233 <b>99211</b>	
	40	12,000	10	662544 <b>00262</b>		666233 <b>99149</b>		666233 <b>99008</b>	666233 <b>99212</b>	662544 <b>72660</b>
	60	12,000	10	662544 <b>00264</b>		666233 <b>99150</b>		666233 <b>99009</b>	666233 <b>99213</b>	662544 <b>72661</b>
	80	12,000	10	662544 <b>00265</b>		666233 <b>99151</b>		666233 <b>99010</b>	666233 <b>99214</b>	662544 <b>72662</b>
	120	12,000	10	662544 <b>00519</b>				666233 <b>99011</b>		
6 x 5/8-11	40	10,200	10	662611 <b>32128</b>	662611 <b>32145</b>				666233 <b>99219</b>	662544 <b>91773</b>
	60	10,200	10	662611 <b>32129</b>	662611 <b>32146</b>				666233 <b>99220</b>	662544 <b>91774</b>
	80	10,200	10	662611 <b>32130</b>	662611 <b>32147</b>				666233 <b>99221</b>	662544 <b>91775</b>
6 x 7/8	36	10,200	10						666233 <b>99215</b>	
	40	10,200	10	662611 <b>32123</b>		666233 <b>99152</b>		666233 <b>99012</b>	666233 <b>99216</b>	662544 <b>91770</b>
	60	10,200	10	662611 <b>32124</b>	662611 <b>32136</b>	666233 <b>99153</b>		666233 <b>99013</b>	666233 <b>99217</b>	662544 <b>91771</b>
	80	10,200	10	662611 <b>32125</b>		666233 <b>99154</b>		666233 <b>99014</b>	666233 <b>99218</b>	
	120	10,200	10					666233 <b>99015</b>		
7 x 5/8-11	36	8,600	10			666233 <b>99155</b>		666233 <b>99134</b>	666233 <b>99222</b>	662544 <b>72669</b>
	40	8,600	10	662544 <b>61066</b>	662611 <b>32148</b>	666233 <b>99156</b>	776960 <b>90092</b>	666233 <b>99016</b>	666233 <b>99067</b>	662544 <b>72670</b>
	60	8,600	10	662544 <b>61067</b>	662611 <b>32168</b>	666233 <b>99157</b>	776960 <b>90093</b>	666233 <b>99017</b>	666233 <b>99068</b>	662544 <b>72671</b>
	80	8,600	10	662544 <b>61068</b>		666233 <b>99158</b>	776960 <b>90094</b>	666233 <b>99018</b>	666233 <b>99069</b>	662544 <b>72672</b>
	120	8,600	10	662544 <b>61069</b>				666233 <b>99019</b>		
7 x 7/8	36	8,600	10	636425 <b>01866</b>		666233 <b>99159</b>		666233 <b>99135</b>	666233 <b>99070</b>	
	40	8,600	10	662544 <b>61059</b>	662611 <b>32138</b>	666233 <b>99160</b>	776960 <b>90089</b>	666233 <b>99020</b>	666233 <b>99071</b>	662544 <b>72665</b>
	60	8,600	10	662544 <b>61060</b>	662611 <b>32139</b>	666233 <b>99161</b>	776960 <b>90090</b>	666233 <b>99021</b>		662544 <b>72666</b>
	80	8,600	10	662544 <b>61061</b>		666233 <b>99162</b>	776960 <b>90091</b>	666233 <b>99022</b>		662544 <b>72667</b>
	120	8,600	10	662544 <b>61063</b>				666233 <b>99023</b>		

V = Vendible package. Ideal for vending machines & small jobs. 2 Flap Discs/pack, 5 packs/carton. Order in multiples of 10.

See Portable Tools and Specialties section for mini flap discs.

Packaged for retail / walk-in selling / small jobs



## BLUEFIRE R884P ZIRCONIA ALUMINA

- Zirconia alumina plus abrasive for aggressive cut and long life
- Individual hang cards provides product selling points; ships in merchandise display case of small quantities
- Available wire rack (with header card) allows merchandising of 4" and 4-1/2" product three ways: hung on pegboard, mounted on an upright, or placed on a shelf/counter



WIRE RACK (WITH HEADER CARD)  
ALLOWS MERCHANDISING OF 4"  
AND 4-1/2" PRODUCT THREE WAYS:  
HUNG ON PEGBOARD, MOUNTED ON  
AN UPRIGHT, OR PLACED ON A  
SHELF/COUNTER

TIER: **BETTER**  
TRADENAME: **BLUEFIRE R884P**  
SHAPE: Type 29  
FLAP DENSITY: Standard  
ABRASIVE: Zirconia Alumina Plus  
BACKING PLATE: Fiberglass

SIZE (D x H)	GRIT	MAX. RPM	STD. PKG.	PART #
4 x M-10	40	15,300	5	076607 <b>03214</b>
	60	15,300	5	076607 <b>03215</b>
	80	15,300	5	076607 <b>03216</b>
4-1/2 x 5/8-11	40	13,300	5	076607 <b>03211</b>
	60	13,300	5	076607 <b>03212</b>
	80	13,300	5	076607 <b>03213</b>
7 x 5/8-11	40	8,600	5	076607 <b>03205</b>
	60	8,600	5	076607 <b>03206</b>
	80	8,600	5	076607 <b>03207</b>
Wire Rack			2	076607 <b>04157</b>



See Portable Tools and Specialties section for mini flap discs.



Non-woven depressed center discs have three components: strong synthetic fiber mesh and quality abrasives, bonded together by a smear-resistant adhesive. Rapid Strip discs have an open web construction that enables aggressive cutting action while maintaining a cool, non-loading surface. Rapid Blend discs have a unitized construction with varying weave – from open to tighter – for deburring and finishing. Rapid Prep discs have a more open weave that excels in surface preparation and cleaning. Each product provides excellent cutting action while improving surface finish.

**Applications:**

Medium-to-light material removal, deburring, blending, cleaning, finishing, and polishing

**Size Range:**

4-1/2" - 7"

**Grit Range:**

X-Coarse, Coarse, Medium, Fine, Very Fine

**Abrasive Grain:**

Ceramic Alumina, Silicon Carbide, Engineered Aluminum Oxide, Aluminum Oxide

**Machine Used:**



RIGHT ANGLE GRINDER



VERTICAL SHAFT PORTABLE GRINDER

**Material/Application-To-Product Recommendation Guide – For All Discs Used on Right Angle Grinders**

Stripping Discs

	<b>BEST</b>	<b>BETTER</b>
	<b>Blaze Rapid Strip Ceramic</b>	<b>Rapid Strip Silicon Carbide</b>
Removing scale and coarse welding marks	◆ XC	◆ XC
Removing coatings, epoxy/glue, paint and other clogging material	◆ XC	◆ XC
Removing rust, oxidation, corrosion and residue	◆ XC	◆ XC
Removing parting lines and seams on fiberglass parts	◆ XC	◆ XC
Removing paint/graffiti from concrete/stone	◆ XC	◆ XC

Deburring, Blending, Finishing Discs

	<b>BEST</b>	<b>BETTER</b>
	<b>Vortex Rapid Blend</b>	<b>Rapid Blend</b>
	<b>Vortex Rapid Prep</b>	<b>Rapid Prep</b>
Removing weld marks and weld spatter	◆ C	◆ C
Stainless steel deburring and cleaning	◆ C	◆ C
Removing small flashings and parting lines	◆ C	◆ C
Surface preparation before coatings/plating		◆ C
Light cleaning		◆ F
Cleaning and prepping welds	◆ M	◆ M
Removing blemishes after welding stainless		◆ M
Blending and finishing all metal parts	◆ VF	◆ VF
Creating decorative finishes on stainless steel	◆ VF	◆ VF
Final finishing and polishing	◆ VF	◆ VF
Final finishing/polishing where high conformability is needed		◆ VF

XC - Extra Course, C - Coarse, M - Medium, F - Fine, VF - Very Fine

**Application/Product Recommendation Guide – For All Discs Used on Right Angle Grinders**

MOST AGGRESSIVE / LEAST CONFORMABLE

LEAST AGGRESSIVE / MOST CONFORMABLE

	Blaze Rapid Strip	Vortex Rapid Blend A/O Med. Rapid Blend A/O Coarse	Rapid Blend A/O Medium	Rapid Blend S/C Fine	
Discs With Back-Up Pad		Vortex Rapid Prep Rapid Prep A/O Coarse	Rapid Prep A/O Medium	Rapid Prep A/O Fine	Rapid Prep Very Fine
Scale Removal	Best Choice	Second Choice			
Stock Removal	Best Choice	Best Choice			
Heavy Deburring	Second Choice	Best Choice			
Light Deburring		Best Choice	Second Choice		
Light Finishing		Second Choice	Best Choice		
Blending			Best Choice	Second Choice	
Finishing			Second Choice	Best Choice	
Polishing				Best Choice	Second Choice

Cross Reference Guide – For All Discs Used on Right Angle Grinders

	STRIPPING (EXTRA COARSE)		SURFACE FINISHING (COARSE – MEDIUM – FINE)			SURFACE PREP (VERY FINE)
	BEST	BETTER	BEST	BETTER	BEST	BETTER
<b>NORTON</b>	<b>Blaze Rapid Strip</b>	<b>Rapid Strip</b>	<b>Vortex Rapid Blend</b>	<b>Rapid Blend</b>	<b>Vortex Rapid Prep</b>	<b>Rapid Prep</b>
3M	Clean & Strip XT PRO, Clean & Strip XT PRO Extra Cut	Clean & Strip X	Debur and Finish PRO, Cut and Polish	EXL	SE, Duraflex	SC, PD, AI, LS
Bibielle	—	SDR Strip-It/Red	—	BUR Unitized	SCHD	SCLS, SCD, SCSB
Camel	—	EZ Strip Black/Red	—	—	—	—
Flexovit	—	Clean & Strip	—	—	—	—
Hermes	Strip Discs	Webrax	—	—	—	—
Pearl	—	S/C Stripping	—	—	—	Surface Preparation
Pferd	—	Policlean	—	Poliflex PUR	—	—
Sait	—	Sait-Strip	—	Unitized	7S, 8S	3Z
SIA	SiaStrip	—	—	—	6260	6250
Standard	—	Cleaning	700/800/900 Series	700/800/900 Series	FE, GP	FE, GP, RC
Superior	—	Stripping	—	XL Unitized	—	FD, GD, CC
Walter	—	FX Cleaning	—	—	—	Blendex Surface Conditioning

Why Choose Non-Woven Depressed Center Discs?

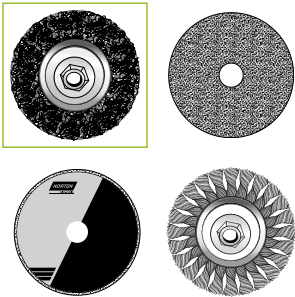

**Non-Woven Right Angle Discs vs. Fiber Discs, Wire Wheels, and Depressed Center Wheels**

- Deburring, blending and finishing done with one product to reduce the number of steps
- To provide a controlled, sustained finish
- To prevent undercutting and gouging
- To provide a cooler grinding action to lessen the chance of warping or discoloration
- When loading is an issue with fiberglass, adhesives and soft metals
- For stripping coatings and paint off of hard materials like concrete, cement and stone
- Less vibration and quieter for high operator acceptance
- To provide an alternative to wire brushes



Blaze Your Way to Greatest Productivity

**Norton Blaze Rapid Strip Type 27 Depressed Center Discs**

Strip/clean Cast Iron, Steels, Aluminum, Fiberglass and composites

- Open structure; will not load on sticky coatings, adhesives, and soft metals (e.g. aluminum), or snag and shed like a cloth or fiber disc might
- Norton Blaze ceramic alumina grain provides 2X cut rate and life over silicon carbide
- Will not shed on heavily rust-encrusted pieces
- Extremely versatile; use one disc; stiff enough to stand abuse, but soft enough to prevent gouging and rework
- Use on edge for blending weld root forms
- Apply some pressure to strip or remove coatings; lighter pressure finishes like a surface finishing disc
- Fewer safety, ergonomic, and environmental issues due to fewer change-outs, less downtime, and less production waste/landfill scrap



## Rapid Strip

Best choice for quick and easy rough cleaning and stripping of all materials



### BLAZE RAPID STRIP CERAMIC ALUMINA

- Blaze ceramic grain provides 2X plus faster, consistent rate and life than silicon carbide discs, leaves a thoroughly cleaned surface, ensuring excellent adhesion in subsequent processes such as painting and soldering
- Open web construction for minimal loading; does not shed or snag on rusty pieces; prevents gouging and rework
- Rapid Strip material provides a unique combination of aggressive performance, long life, and improved finish

Better choice for use on a variety of materials, including metal, fiberglass and stone



### RAPID STRIP SILICON CARBIDE

- Sharp silicon carbide abrasive provides fast aggressive cutting action
- Advanced resin bond prevents shedding, snagging, gouging, and rework
- Open web construction for minimal loading; great alternative to wire brushes

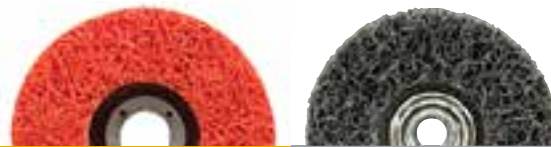

		<b>TIER: BEST</b>		<b>TIER: BETTER</b>		
		<b>BLAZE RAPID STRIP</b>		<b>RAPID STRIP</b>		
<i>TRADENAME:</i>		Ceramic Alumina		Silicon Carbide		
<i>ABRASIVE:</i>		36-50		36-50		
<i>GRIT SIZE:</i>		X-Coarse		X-Coarse		
<i>GRADE:</i>		Type 27/Fiberglass		Type 27/Fiberglass		
<i>TYPE/BACKING:</i>		SIZE (D x H)	MAX. RPM	STD. PKG.	PART #	PART #
		4-1/2 x 5/8-11	12,000	10	662544 <b>98101</b>	662610 <b>09585</b>
		4-1/2 x 7/8	12,000	10	666233 <b>03783</b>	662610 <b>09649</b>
		5 x 5/8-11	11,000	10	666233 <b>03915</b>	
		5 x 7/8	11,000	10	666233 <b>03916</b>	
		7 x 5/8-11	8,000	10	666233 <b>03919</b>	662610 <b>09650</b>
		7 x 7/8	8,000	10	666233 <b>03920</b>	662610 <b>09586</b>

## Rapid Blend

Best choice with revolutionary technology for heavy deburring and finishing



### VORTEX RAPID BLEND ALUMINUM OXIDE

- Proprietary engineered Vortex aluminum oxide agglomerated grain performs the medium to fine grit steps of traditional aluminum oxide discs
- Thick nylon web for 2X longer life and faster finishing vs. traditional aluminum oxide discs, with minimal shedding
- Special resin chemistry resists shedding when used on sharp edges, making it ideal for deburring; no smearing

Better choice for surface prep, deburring, blending and removing parting lines, rust, and coatings



### RAPID BLEND NEX A/O / S/C

- Premium aluminum oxide or silicon carbide grain for consistent performance
- Uniform construction extends life and maintains part tolerance; prevents cutting and gouging
- Resin formula produces consistent, smear-free finishes

Consistent smear free performance with low entry price



### RAPID BLEND ALUMINUM OXIDE

- Premium aluminum oxide grain; engineered for more demanding applications
- Uniform construction maintains part tolerance; prevents cutting and gouging
- Smear-free bond excels at producing light satin finishes

MOST AGGRESSIVE / LEAST CONFORMABLE ← → LEAST AGGRESSIVE / MOST CONFORMABLE



	<b>BEST</b>		<b>BETTER</b>		<b>BETTER</b>		<b>BETTER</b>		<b>BETTER</b>	
	<b>VORTEX RAPID BLEND</b>		<b>RAPID BLEND NEX</b>		<b>RAPID BLEND NEX</b>		<b>RAPID BLEND NEX</b>		<b>RAPID BLEND</b>	
TRADENAME:	Engineered A/O		Aluminum Oxide		Aluminum Oxide		Silicon Carbide		Aluminum Oxide	
GRIT SIZE:	100-120		150-180		220-280		320-400		150-180	
SPECIFICATION:	Vortex 5AM		NEX-2AM		NEX-2AF		NEX-2SF		High Strength Medium	
TYPE/BACKING:	Type 27/Fiberglass		Type 27/Fiberglass		Type 27/Fiberglass		Type 27/Fiberglass		Type 27/Fiberglass	
SIZE (D x H)	MAX. RPM	STD. PKG.	PART #	PART #	PART #	PART #	PART #	PART #	PART #	
4-1/2 x 5/8-11	12,000	10	662544 <b>29243</b>	662610 <b>23947</b>	662610 <b>23946</b>	662610 <b>23943</b>	662610 <b>23949</b>	662610 <b>23949</b>	662610 <b>23949</b>	
4-1/2 x 7/8	12,000	10	662544 <b>29268</b>	662610 <b>20548</b>	662610 <b>20547</b>	662610 <b>20546</b>	662610 <b>20549</b>	662610 <b>20549</b>	662610 <b>20549</b>	



# Non-Woven Standard Back-up Pad Discs

Rapid Prep  
7/8" Center Hole

Best choice for aggressive stock removal and blending in one step



## RAPID PREP XHD

- Coarse and Medium discs solve your most aggressive stock removal and blending challenges; remove weld lines, weld spatter, weld discoloration and blend surfaces in a single step
- Improve cut control and surface blending over traditional coated flap discs and fiber discs from our unique combination of a conformable fiber matrix and premium ceramic grain
- XHD Coarse discs for aggressive weld removal and surface blending on steels and Medium discs on softer metals/alloys



TIER: **BEST**  
 TRADENAME: **RAPID PREP XHD**  
 ABRASIVE: Ceramic Alumina

SIZE (D x H)	STD. PKG.	PART #
<b>Coarse</b>		
4-1/2" x 7/8"	40	662611 <b>70275</b>
5" x 7/8"	40	662611 <b>70279</b>
7" x 7/8"	25	662611 <b>70280</b>
<b>Medium</b>		
4-1/2" x 7/8"	40	662611 <b>70282</b>
5" x 7/8"	40	662611 <b>70283</b>
7" x 7/8"	25	662611 <b>70284</b>

All Vortex and Rapid Prep 7/8 hole discs are non-stock. Contact your Norton representative for current order quantities, and lead-times.

Note: Max RPM is determined by corresponding back up pad.

## Norton Rapid Prep Surface Conditioning Products

The Perfect Abrasive, Coating, and Bond Built into Every Disc and Belt

- Available in premium Vortex aluminum oxide aggregate grain and Norton aluminum oxide grain; ideal for many aerospace, metal and stainless steel fabrication, and MRO applications
- Our proprietary coating method extends life and delivers consistent finishes by creating a thick layer of grain throughout the product; grain does not sit on top of fibers as other competitive products can
- Our new Clean Bond resin system guarantees smear-free finishes, even on high nickel content alloys; will not load on aluminum and soft metals, as competitive products can



Rapid Prep  
7/8" Center Hole

Best choice for finishing and blending applications



## VORTEX RAPID PREP ALUMINUM OXIDE DISCS

- High-performing, patented Vortex agglomerated aluminum oxide grain provides the cutting power of a coarser grit with the finish of finer grits
- Premium high-loft nylon fiber bonded to a strong nylon scrim backing allows a thick layer of resin bond and grain for extended life and provides added durability and stiffness
- Proprietary Clean Bond resin technology guarantees smear-free finishes even on high nickel content alloys and reduces loading on aluminum and other soft metals

Better choice for high nickel content alloys, aluminum and other soft metals



## RAPID PREP ALUMINUM OXIDE

- Quality aluminum oxide abrasive grain coating provides up to 20% higher cut rate and 50% better performance than competitive products
- Premium high-loft nylon fiber bonded to a strong nylon scrim backing allows a thick layer of resin bond and grain for extended life, added durability and stiffness
- Proprietary Clean Bond resin technology guarantees smear-free finishes even on high nickel content alloys and reduces loading on aluminum and other soft metals



	TIER: BEST		BETTER	
	TRADENAME: VORTEX RAPID PREP		RAPID PREP	
	ABRASIVE: Engineered Aluminum Oxide		Aluminum Oxide	
SIZE (D x H)	STD. PKG.	PART #		PART #
<b>Extra Coarse</b>				
4-1/2" x 7/8"	25			666233 <b>26070</b>
5" x 7/8"	25	666233 <b>34975</b>		
7" x 7/8"	25	666233 <b>41360</b>		
<b>Coarse</b>				
4-1/2" x 7/8"	25	666233 <b>34944</b>		662544 <b>73868</b>
5" x 7/8"	25	666233 <b>34946</b>		662610 <b>08293</b>
7" x 7/8"	25	666233 <b>41362</b>		666233 <b>25138</b>
<b>Medium</b>				
4-1/2" x 7/8"	25	666233 <b>33612</b>		666233 <b>25915</b>
5" x 7/8"	25	666233 <b>34963</b>		662610 <b>17124</b>
7" x 7/8"	25	666233 <b>41364</b>		666233 <b>25919</b>
<b>Fine</b>				
4-1/2" x 7/8"	25	666233 <b>33608</b>		666233 <b>25153</b>
5" x 7/8"	25	666233 <b>34954</b>		662544 <b>69132</b>
7" x 7/8"	25	666233 <b>41366</b>		666233 <b>25897</b>
<b>Very Fine</b>				
4-1/2" x 7/8"	25	666233 <b>33616</b>		
5" x 7/8"	25			666233 <b>25943</b>
7" x 7/8"	25	666233 <b>41368</b>		666233 <b>25959</b>

All these discs are non-stock. Contact your Norton representative for current order quantities, and lead-times.  
Note: Max RPM is determined by corresponding back-up pad.

See page 54 for 7/8" Hole Air Cooled Back-up Pads

## Rapid Prep

### Speed Change 5/8"-11

- These discs feature Norton quick, tool-free, twist-on and -off Speed-Change fasteners. Discs lock to standard back-up pads with a unique nut design and are easily removed, increasing your productivity with more time to grind.



TIER: **BEST**  
 TRADENAME: **RAPID PREP XHD**  
 ABRASIVE: Ceramic Alumina

SIZE (D x H)	STD. PKG.	PART #
<b>Coarse</b>		
4-1/2" x 5/8-11"	25	662611 <b>70060</b>
5" x 5/8-11"	25	662611 <b>70061</b>
7" x 5/8-11"	25	662611 <b>70288</b>
<b>Medium</b>		
4-1/2" x 5/8-11"	25	662611 <b>70062</b>
5" x 5/8-11"	25	662611 <b>70063</b>
7" x 5/8-11"	25	662611 <b>70289</b>

Max RPM is determined by corresponding back up pad.



TIER: **BEST** | **BETTER**  
 TRADENAME: **VORTEX RAPID PREP** | **RAPID PREP**  
 ABRASIVE: Engineered Aluminum Oxide | Aluminum Oxide

SIZE (D x H)	STD. PKG.	PART #	PART #
<b>Extra Coarse</b>			
4-1/2" x 5/8-11"	25	666233 <b>73667</b>	666233 <b>73690</b>
5" x 5/8-11"	25	666233 <b>73669</b>	
7" x 5/8-11"	25	666233 <b>73670</b>	666233 <b>73692</b>
<b>Coarse</b>			
4-1/2" x 5/8-11"	25	666233 <b>73671</b>	666233 <b>73693</b>
5" x 5/8-11"	25	666233 <b>73674</b>	662544 <b>98516</b>
7" x 5/8-11"	25	666233 <b>73675</b>	662611 <b>92908</b>
<b>Medium</b>			
4-1/2" x 5/8-11"	25	666233 <b>73678</b>	666233 <b>08157</b>
5" x 5/8-11"	25	666233 <b>73679</b>	666233 <b>73694</b>
7" x 5/8-11"	25	666233 <b>73680</b>	662611 <b>92913</b>
<b>Fine</b>			
4-1/2" x 5/8-11"	25	666233 <b>73681</b>	
5" x 5/8-11"	25	666233 <b>73682</b>	666233 <b>73695</b>
7" x 5/8-11"	25	666233 <b>73684</b>	
<b>Very Fine</b>			
5" x 5/8-11"	25	666233 <b>73686</b>	666233 <b>73699</b>
7" x 5/8-11"	25	666233 <b>73687</b>	666233 <b>73700</b>

Note: Speed Change discs must always be used with smooth face back-up pads.  
 Max RPM is determined by corresponding back-up pad.

## AVOS Non-Woven Speed-Lok

- Patented hole design allows for interrupted cut, reducing heat up to 30% over standard surface preparation discs for cooler cutting and longer life
- With complete vision into the grinding zone, operators can grind more accurately with less re-work; scooped holes create air glow to pull loose abrasive and swarf away from work surface grinding zone – resulting in extended disc life
- The 15° angle back-up pad lets you grind at 5° - 15° angle allowing for greater utilization of disc surface and eliminates gouging of workpiece

See page 54 for Speed Change and AVOS Back-up Pads



TIER: **BETTER**  
 TRADENAME: **RAPID PREP AVOS**  
 ABRASIVE: Aluminum Oxide

SIZE (DIAMETER)	STD. PKG.	PART #
<b>Coarse</b>		
4-1/2"	10	662610 <b>10447</b>
5"	10	666233 <b>74818</b>
<b>Medium</b>		
4-1/2"	10	662610 <b>10448</b>
5"	10	666233 <b>74819</b>
<b>Very Fine</b>		
4-1/2"	10	666233 <b>74823</b>
5"	10	666233 <b>74824</b>

Note: AVOS discs must be used with AVOS Speed-Lok back-up pads.  
 Max RPM is determined by corresponding back up pad.

# Non-Woven Hook and Loop Discs

## Rapid Prep

### Non-Woven Hook and Loop Discs



TIER: **BEST**  
 TRADENAME: **RAPID PREP XHD**  
 ABRASIVE: Ceramic Alumina

SIZE (DIAMETER)	STD. PKG.	PART #
<b>Coarse</b>		
4-1/2	40	662611 <b>70179</b>
5	40	662611 <b>70181</b>
7	25	662611 <b>70182</b>
<b>Medium</b>		
4-1/2	40	662611 <b>70183</b>
5	40	662611 <b>70185</b>
7	25	662611 <b>70186</b>

Max RPM is determined by corresponding back-up pad.

\* Standard Package = 80

## Back-up Pads

### Hook & Loop Back-up Pads

PAD DIAMETER	SPINDLE OR HOLE SIZE	MAX. RPM	3M EQUIVALENT	STD. PKG.	PART #
<b>Back-up Pads for Hook and Loop Discs</b>					
2	1/4 Steel Shank	23,000	922	5	662610 <b>59352</b>
3	1/4 Steel Shank	20,000	923	5	662610 <b>59354</b>
4	1/4 Steel Shank	18,000	924	5	662610 <b>59356</b>
	5/8-11	13,000	914	5	662610 <b>59304</b>
	M10 x 1.250	13,000		5	662610 <b>59305</b>
4-1/2	5/8-11	10,000	9145	5	662610 <b>06948</b>
5	5/16-24 Male	10,000	905	5	662610 <b>59360</b>
	5/8-11	10,000	915	5	662610 <b>59310</b>
6	5/8-11	8,000	916	5	662610 <b>59312</b>
7	5/8-11	6,000	917	5	662610 <b>59368</b>
8	5/8-11	4,500	918	5	662610 <b>59372</b>

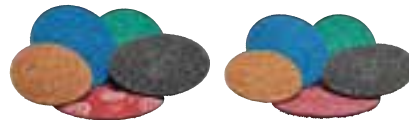

TIER: **BEST** **BETTER**  
 TRADENAME: **VORTEX RAPID PREP** **RAPID PREP**  
 ABRASIVE: Engineered Aluminum Oxide Aluminum Oxide

SIZE (DIAMETER)	STD. PKG.	PART #	PART #
<b>Extra Coarse</b>			
2	50		662610 <b>17900</b>
3	25	666233 <b>33620</b>	
4-1/2	25	666233 <b>34972</b>	662610 <b>17906</b>
5	25	666233 <b>34974</b>	662610 <b>17215</b>
7	25	666233 <b>34976</b>	662611 <b>92846</b>
<b>Coarse</b>			
2	50	666233 <b>34882</b>	662610 <b>04431</b> *
3	25	666233 <b>34883</b>	662610 <b>55015</b>
4-1/2	25	666233 <b>34943</b>	662610 <b>17806</b>
5	25	666233 <b>34945</b>	662610 <b>04435</b>
7	25	666233 <b>34951</b>	662610 <b>55027</b>
<b>Medium</b>			
2	50	666233 <b>34958</b>	662610 <b>04441</b>
3	25	666233 <b>34956</b>	662610 <b>04442</b>
4-1/2	25	666233 <b>34961</b>	662610 <b>04444</b>
5	25	666233 <b>34962</b>	662610 <b>55022</b>
7	25	666233 <b>34965</b>	662610 <b>17813</b>
<b>Fine</b>			
2	50	666233 <b>33604</b>	666233 <b>25141</b>
3	25	666233 <b>33605</b>	666233 <b>25143</b>
4-1/2	25	666233 <b>33607</b>	666233 <b>25147</b>
5	25	666233 <b>33609</b>	666233 <b>25154</b>
7	25	666233 <b>34955</b>	662611 <b>99465</b>
<b>Very Fine</b>			
2	50	666233 <b>33613</b>	666233 <b>25926</b>
3	25	666233 <b>33614</b>	666233 <b>25934</b>
4-1/2	25	666233 <b>33615</b>	666233 <b>25936</b>
5	25	666233 <b>33617</b>	666233 <b>25941</b>
7	25	666233 <b>34969</b>	662610 <b>19990</b>

Max RPM is determined by corresponding back-up pad.

\* Standard Package = 80





Norton PSA (pressure sensitive adhesive) individual cloth discs are used on four different types of machines and the application changes depending on which machine they are used on.

**Applications:**

Pneumatic and Electric Dual-Action (DA) and Electric Random Orbital Sanders – for use on contours or flat surfaces for light- to medium-pressure grinding, blending, leveling, and finishing applications.

Stationary Disc Sanders – used in woodworking and metalworking for stock removal, sanding/grinding flat surfaces, dimensioning and finishing.

**Size Range:**

5" – 24" diameter

**Grit Range:**

24 – 180

**Abrasive Grain:**

Ceramic Alumina, Zirconia Alumina, Aluminum Oxide

**Back-up Pads:**

Rubber, with hardness variations for different applications, for portable machines. Steel for stationary disc sanders.

**Machine Used:**



ORBITAL SANDER

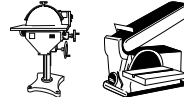

STATIONARY DISC SANDERS

Best choice for all hard-to-grind high alloy steels



BLAZE R980P CERAMIC ALUMINA

- 100% ceramic alumina micro-fracturing grain constantly exposes sharper grain edges to provide fastest cut rate and longest life over competitive blended/low-ratio ceramic alumina discs
- Strong resin bond and heavy-duty Y-weight polyester backing for consistent cut, better grain adhesion, edge-tear resistance, and durability
- Self-lubricating grinding aid treatment delivers the coolest cut on stainless steel, high alloy steels, super alloys, titanium, and other difficult to grind materials

Better choice for grinding and deburring stainless steel



BLUEFIRE R821P ZIRCONIA ALUMINA

- Latest generation of self-sharpening, zirconia alumina abrasive for cooler cut and extended life over aluminum oxide discs
- Heavy-duty Y-weight cotton backing for edge-tear resistance and durability
- Pressure sensitive adhesive makes for easy application and removal

Good choice for general-purpose metalworking



GEMINI R228 ALUMINUM OXIDE

- Premium aluminum oxide abrasive gives an excellent initial cut rate
- Durable X-weight cotton backing makes these discs a good blend of flexibility and life
- The cotton backing provides good resistance to heat

Good option for light- to medium-pressure grinding, blending, leveling and finishing applications



METAL R243 ALUMINUM OXIDE

- Aluminum Oxide grain provides consistent cut for general purpose use
- Improved resin bond system provides longer life
- Flexible J-weight cotton backing for added conformability, tabs allow for easy liner removal

Cloth PSA Discs for Dual-Action and Random Orbital Sanders



TIER:	<b>BEST</b>	<b>GOOD</b>	<b>GOOD</b>
TRADENAME:	<b>BLAZE R980P</b>	<b>GEMINI R228</b>	<b>METAL R243</b>
ABRASIVE:	Ceramic Alumina	Aluminum Oxide	Aluminum Oxide
ATTACHMENT:	PSA Discs	PSA Discs	PSA Discs
OTHER:	Supersize		

SIZE (D)	GRIT	PKG./CASE	PART #	PART #	PART #
5	36	50/250	662544 <b>61506*</b>	662611 <b>36589</b>	
	40	50/250	662544 <b>61507</b>	662611 <b>36588</b>	
	50	50/250	662544 <b>61508</b>	662611 <b>36587</b>	
	60	50/250	662544 <b>61509</b>	662611 <b>36586</b>	
	80	50/250	662544 <b>61510</b>	662611 <b>36585</b>	699573 <b>39967</b>
	100	50/250		662611 <b>36584</b>	699573 <b>39968</b>
	120	50/250	662544 <b>61512</b>	662611 <b>36583</b>	699573 <b>39969</b>
	150	50/250		662611 <b>36582</b>	699573 <b>39970</b>
	180	50/250		662611 <b>36581</b>	699573 <b>39971</b>
	6	60	50/250		662611 <b>36596</b>
80		50/250		662611 <b>36595</b>	699573 <b>39973</b>
100		50/250		662611 <b>36594</b>	699573 <b>39977</b>
120		50/250		662611 <b>36593</b>	699573 <b>39978</b>
150		50/250			699573 <b>39979</b>
180		50/250		662611 <b>36592</b>	699573 <b>39986</b>
8	36	50/250		662611 <b>36350</b>	
	40	50/250		662611 <b>36351</b>	
	50	50/250		662611 <b>36352</b>	
	60	50/250		662611 <b>36356</b>	
	80	50/250		662611 <b>36354</b>	
	120	50/250		662611 <b>36355</b>	

\*PKG./Case: Blaze R980P 5" 36 grit discs = 50/200



Back-up Pads for Cloth PSA Discs

DESCRIPTION	MAX. RPM	STD. PKG.	PART #
<b>Back-up Pads for Cloth PSA Discs</b>			
5" Diameter – Low Profile – Soft	12,000	5	636425 <b>06126</b>
5" Diameter – Low Profile – Medium	12,000	5	636425 <b>06131</b>
5" Diameter – Tapered – Medium	12,000	5	636425 <b>06139</b>
6" Diameter – Low Profile – Soft	10,000	5	636425 <b>06127</b>
6" Diameter – Low Profile – Med	10,000	5	636425 <b>06133</b>
6" Diameter – Tapered – Medium	10,000	5	636425 <b>06141</b>
8" Diameter – Tapered – Medium	6,000	5	636425 <b>43112</b>

## Large Diameter Cloth PSA Discs

Used on stationary disc machines for dimensioning and finishing metal workpieces and woodworking. Pressure sensitive adhesive offers fast, convenient mounting. Made without center holes for full-face usage.



TIER:	BEST	BETTER	GOOD
TRADENAME:	<b>BLAZE R980P</b>	<b>BLUEFIRE R821P</b>	<b>GEMINI R228</b>
ABRASIVE:	Ceramic Alumina	Zirconia Alumina	Aluminum Oxide
ATTACHMENT:	PSA	PSA	PSA
OTHER:	Supersize		

SIZE (D)	GRIT	PKG./CASE	PART #	PART #	PART #
10	36	25/50			662611 <b>36606</b>
	40	25/50		662611 <b>38314</b>	662611 <b>36604</b>
	50	25/50			662611 <b>36607</b>
	60	25/50		662611 <b>38316</b>	662611 <b>36602</b>
	80	25/50		662611 <b>38317</b>	662611 <b>36601</b>
	100	25/50			662611 <b>36600</b>
12	24	25/50		662611 <b>38318</b>	
	36	25/50	662544 <b>16171</b>	662611 <b>38319</b>	662611 <b>36635</b>
	40	25/50	662544 <b>16172</b>	662611 <b>38320</b>	662611 <b>36630</b>
	50	25/50	662544 <b>16173</b>	662611 <b>38321</b>	662611 <b>36625</b>
	60	25/50	662544 <b>16174</b>	662611 <b>38322</b>	662611 <b>36620</b>
	80	25/50	662544 <b>16175</b>	662611 <b>38323</b>	662611 <b>36615</b>
	100	25/50			662611 <b>36614</b>
	120	25/50	662544 <b>16176</b>		662611 <b>36613</b>
15	36	25/50			662611 <b>36666</b>
	60	25/50			662611 <b>36663</b>
	80	25/50			662611 <b>36662</b>
16	36	25/50			662611 <b>36700</b>
	40	25/50			662611 <b>36685</b>
	50	25/50			662611 <b>36684</b>
	60	25/50		662611 <b>38334</b>	662611 <b>36683</b>
	80	25/50			662611 <b>36701</b>
18	36	25/50			662611 <b>36720</b>
	60	25/50			662611 <b>36696</b>
	80	25/50			662611 <b>36723</b>
20	36	25/50	662544 <b>16165</b>	662611 <b>38343</b>	662611 <b>36710</b>
	40	25/50		662611 <b>38344</b>	662611 <b>36709</b>
	50	25/50	662544 <b>16167</b>		662611 <b>36711</b>
	60	25/50	662544 <b>16168</b>	662611 <b>38346</b>	662611 <b>36712</b>
	80	25/50	662544 <b>16169</b>		662611 <b>36706</b>
	120	25/50	662544 <b>16170</b>		
24	36	10/10			662611 <b>36718</b>
	40	10/10			662611 <b>36717</b>
	50	10/10			662611 <b>36725</b>
	60	10/10			662611 <b>36726</b>
	80	10/10			662611 <b>36727</b>



For use on dual action and random orbital sanders. The industry's highest performing and broadest selection of paper discs in PSA (pressure sensitive adhesive) disc rolls and individual discs, and hook and loop discs.

- Applications:** Stripping and preparing primed and painted surfaces for finishing, sanding of plastics, fiberglass and composites, bare wood sanding, light weld blending, preparing and finishing metal, and sanding of all gel coat and body filler compounds.
- Size Range:** 3" – 8"
- Grit Range:** 36 – 1500
- Abrasive Grain:** Ceramic Alumina, Zirconia Alumina, Aluminum Oxide, Silicon Carbide
- Attachment Systems:** PSA (pressure-sensitive adhesive), hook and loop
- Paper Weights:** Heavyweight – E and F; Lightweight – B, C, and D
- Vacuum Holes:** See product availability charts
- Machine Used:**



ORBITAL SANDER



VERTICAL SHAFT PORTABLE GRINDER

## Material/Application-to-Product Recommendation Guide

	BEST			BETTER		GOOD	
	Heavy-Medium Stock Removal	Light Stock Removal Finishing		Heavy-Medium Stock Removal		Light Stock Removal Finishing	Light Stock Removal Finishing
	SG H920	Blaze A995	Dry Ice A975	BlueFire H875P	BlueFire H822	A2750P	Gold Reserve A296
Primed, Painted Surfaces		◆	◆	◆		◆	◆
Fiberglass / Composites / Gel Coats		◆	◆	◆		◆	◆
Wood		◆	◆	◆		◆	◆
Metal	◆	◆	◆		◆	◆	◆
Body Fillers / Compounds / Plastics		◆	◆	◆		◆	◆

## Application/Grit Recommendation Guide

COARSER (GRINDING)											FINER (FINISHING)								
36	40	60	80	100	120	150	180	220	240	280	320	360	400	500	600	800	1000	1200	1500
Roughing to Intermediate			Intermediate to Finishing							Fine Finishing			Ultra Fine Finishing						

## Cross Reference Guide

	TOTAL PERFORMANCE						INITIAL PRICE		
	BEST			BETTER			GOOD		
NORTON	F-Weight SG H920	X-Weight Blaze A995	B- & C-Weight Dry Ice A975	F-Weight BlueFire H822	E-Weight BlueFire H875P	B-Weight A275 OP	B-Weight Durite A475	C-Weight A290	B-Weight Gold Reserve A296
3M	763U	732U, 737U, 755L 775L	334U, 734U, 735U	—	740I, 745I, 750U, 751U, 751I	216U, 255L, 236U, 260L, 334U	405N, 414N, 415U, 426U, 435U	236U, 316U, NX	216U, 236U
Hermes	BW114, CR116	CR116	—	BW115, BW184	BW110, VC153	VC154-LL	SF168	VC151-LL, VC152, WA flex 28	—
Indasa	—	HT Line	HT Line, RedLine	—	HeavyLine	PlusLine	—	WhiteLine, YellowLine	—
Klingspor	PS61	—	PS36	PS21	PS36	PS33, PS73W	PL35, PS14	PS33	PL36
Mirka	—	—	—	—	Royal CRS. Cut	Q-Silver, Royal Micro	CaratFlex, PolarStar	Bulldog Gold, Basecut	Bulldog Gold
SIA	—	—	Siaprime 5550, 1958	1820	1820, 1919, 1948	1940, 1944, 1950	1748	1947, 1960	—
VSM	—	—	—	—	KP510E, KP709	—	CP131A	KP911	—



## Heavyweight Paper Discs

Best choice for most demanding stock removal applications



### SG H920 CERAMIC ALUMINA

- Durable and friable Norton seeded gel ceramic alumina abrasive ensures fast, aggressive, yet cool cutting action and maximum life
- Strong F-weight paper, synthetically-coated, provides maximum durability and resistance to edge chipping and shedding
- Closed coat and sharp grain make this a premiere product for metal fabricating and blending; ideal for soldered and welded areas

Better choice for aggressive metalworking applications



### BLUEFIRE H822 ZIRCONIA ALUMINA

- Patented zirconia alumina abrasive provides 2X-3X life over aluminum oxide products
- Strong F-weight paper, synthetically-coated for excellent durability and chip resistance; pressure sensitive adhesive and linked disc roll format allow easy application, removal, and dispensing
- Non-stearated (no anti-loading agents) for non-contaminating; often required for prime auto and aerospace paint applications

Better choice for soft material and wood applications



### BLUEFIRE H875P ZIRCONIA ALUMINA

- Next-generation, self-sharpening zirconia alumina abrasive provides 2-3 times the life of aluminum oxide discs, longer life versus original zirconia alumina discs, improved cut rate, and minimal heat
- Strong E-weight latex/paper backing resists tearing while staying conformable and flexible
- Open coat contributes to minimized loading

Stick & Sand (PSA)  
Heavyweight Disc Rolls  
Non-Vacuum

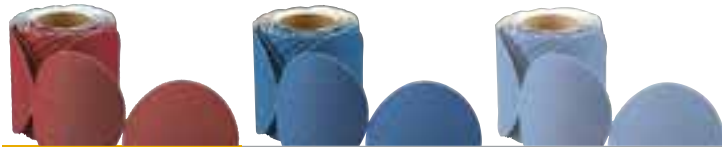

				TIER: <b>BEST</b>	<b>BETTER</b>	<b>BETTER</b>
				TRADENAME: <b>SG H920</b>	<b>BLUEFIRE H822</b>	<b>BLUEFIRE H875P</b>
				ABRASIVE: Ceramic Alumina	Zirconia Alumina	Zirconia Alumina
				PAPER BACKING WEIGHT: F-Weight	F-Weight	E-Weight
				FASTENING: PSA	PSA	PSA
SIZE	GRIT	ROLLS/STD. PKG.	DISCS/ ROLL	PART #	PART #	PART #
5	60	4	100	662611 <b>49873</b>	662611 <b>37310</b>	
	80	4	100	662611 <b>49872</b>	662611 <b>37309</b>	662611 <b>24977</b>
	100	4	100	662611 <b>49871</b>	662611 <b>37308</b>	
	120	4	100	662611 <b>49870</b>	662611 <b>37307</b>	
6	60	4	100		662611 <b>37323</b>	
	80	4	100	662611 <b>49876</b>	662611 <b>37322</b>	662611 <b>25573</b>
	120	4	100	662611 <b>49874</b>		
8	100	4	50	662611 <b>49879</b>		
	120	4	50		662611 <b>37333</b>	

Refer to the Sanding Accessories section for back-up pads and accessories.

### Heavyweight Paper Discs

Stick & Sand (PSA)  
Individual Discs  
Non-Vacuum and Vacuum



TIER:	<b>BETTER</b>	<b>BETTER</b>
TRADENAME:	<b>BLUEFIRE H875P</b>	<b>BLUEFIRE H875P</b>
ABRASIVE:	Zirconia Alumina	Zirconia Alumina
PAPER BACKING WEIGHT:	E-Weight	E-Weight
FASTENING:	PSA	PSA Vacuum

SIZE	GRIT	PKG./CASE	PART #	PART #
5	36	50/200	662611 <b>25436</b>	
	40	50/200	662611 <b>25307</b>	
	80	50/200	662611 <b>25244</b>	

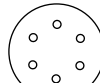

6" x 6 Hole  
Die #3371

6	36	50/200	662611 <b>23575</b>	
	40	50/200	662611 <b>23574</b>	662611 <b>23580</b>
	80	50/200	662611 <b>23573</b>	

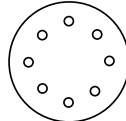

8" x 8 Hole  
Die #3370

8	36	25/100	662611 <b>23578</b>	662611 <b>23584</b>
	40	25/100	662611 <b>23577</b>	
	80	25/100	662611 <b>23576</b>	662611 <b>23582</b>

Hook & Loop  
Individual Discs  
Non-Vacuum and Vacuum



TIER:	<b>BEST</b>	<b>BETTER</b>	<b>BETTER</b>
TRADENAME:	<b>SG H920</b>	<b>BLUEFIRE H875P</b>	<b>BLUEFIRE H875P</b>
ABRASIVE:	Ceramic Alumina	Zirconia Alumina	Zirconia Alumina
PAPER BACKING WEIGHT:	F-Weight	E-Weight	E-Weight
FASTENING:	Hook & Loop	Hook & Loop	Hook & Loop
OTHER:			Vacuum

SIZE	GRIT	PKG./CASE	PART #	PART #	PART #
5	40	25/100		662611 <b>25684</b>	
	60	50/250	662611 <b>49864</b>		
	80	50/250	662611 <b>49865</b>	662611 <b>25444*</b>	
	100	50/250	662611 <b>49866</b>		
	120	50/250	662611 <b>49867</b>		
6	36	25/100		662611 <b>23590</b>	
	40	25/100		662611 <b>23589</b>	
	80	25/100		662611 <b>23588</b>	

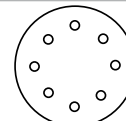

8" x 8 Hole  
Die #3370

8	36	25/100		662611 <b>23593</b>	662611 <b>23598</b>
	40	25/100		662611 <b>23592</b>	
	80	25/100		662611 <b>23591</b>	662611 <b>23596</b>

Packaging Standards: Min. / Std. Pkg. \* H875P = 25/100

Lightweight Paper Discs

Less dust; more productivity



## MULTI-AIR CYCLONIC HOOK & LOOP VACUUM

- Multi-Air Cyclonic precision laser-cut, spiral vacuum hole design maximizes dust extraction for cleanest work environment and less potential for contamination, while delivering coolest, fastest, most consistent cut rate, and longest life of any paper disc
- Water-based, non-pigmented stearate No-Fil coating and open coat provide maximum load resistance and no color transfer to work
- Exceptional choice for the most demanding paper disc sanding applications; hook and loop back for easy disc mounting and changing



TIER:	BEST	BEST
TRADENAME:	<b>BLAZE A995 NO-FIL</b>	<b>DRY ICE A975 NO-FIL</b>
ABRASIVE:	Ceramic Alumina	Ceramic Alumina
PAPER BACKING WEIGHT:	C- & D-Weight	B- & C-Weight
FASTENING:	Hook & Loop	Hook & Loop
OTHER:	P-Graded	P-Graded



SIZE	GRIT	PKG/CASE	PART #	PART #
3 x 0	80	50/200		776960 <b>95005</b>
	120	50/200		776960 <b>95006</b>
	150	50/200		776960 <b>95007</b>
	180	50/200		776960 <b>95008</b>
	220	50/200		776960 <b>95009</b>
	240	50/200		776960 <b>95010</b>
	320	50/200		776960 <b>95011</b>
	400	50/200		776960 <b>95012</b>
	500	50/200		776960 <b>95013</b>
	600	50/200		776960 <b>95014</b>
5 x 11/16 (125mm x 18mm)	800	50/200		776960 <b>95015</b>
	1000	50/200		776960 <b>95016</b>
	80	50/200	636425 <b>97500</b>	776960 <b>07745</b>
	120	50/200	636425 <b>97501</b>	776960 <b>07753</b>
	150	50/200	636425 <b>97502</b>	776960 <b>07755</b>
	180	50/200	636425 <b>97503</b>	776960 <b>07756</b>
	220	50/200	636425 <b>97504</b>	776960 <b>07757</b>
	240	50/200		776960 <b>07760</b>
	280	50/200		776960 <b>07762</b>
	320	50/200		776960 <b>07763</b>
6 x 11/16 (150mm x 18mm)	400	50/200		776960 <b>07765</b>
	500	50/200		776960 <b>07768</b>
	600	50/200		776960 <b>07791</b>
	800	50/200		776960 <b>07793</b>
	1000	50/200		776960 <b>07795</b>
	80	50/200	636425 <b>97505</b>	776960 <b>07770</b>
	120	50/200	636425 <b>97506</b>	776960 <b>07773</b>
	150	50/200	636425 <b>97507</b>	776960 <b>07774</b>
	180	50/200	636425 <b>97508</b>	776960 <b>07775</b>
	220	50/200	636425 <b>97509</b>	776960 <b>07776</b>
240	50/200		776960 <b>07777</b>	
280	50/200		776960 <b>07778</b>	
320	50/200		776960 <b>07781</b>	
400	50/200		776960 <b>07784</b>	
500	50/200		776960 <b>07785</b>	
600	50/200		776960 <b>07786</b>	
800	50/200		776960 <b>07787</b>	
1000	50/200		776960 <b>07788</b>	

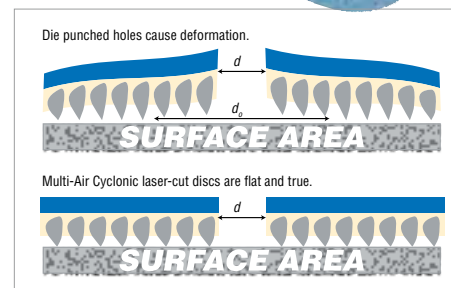

### Improved Dust Extraction / Increased Productivity

The upgrade to precise, flat, laser-cut holes instead of die-punched holes, dramatically increases surface area contact allowing Norton Multi-Air Cyclonic discs to improve productivity by 32% versus conventional multi-hole sanding and by 60% versus non-vacuum sanding.

The end result is more holes for dust extraction, more abrasive coverage for a better cut and no deformation – for full surface contact utilizing all the cutting power of the premium ceramic grain.

Refer to the Sanding Accessories section for back-up pads and accessories.

## Lightweight Paper Discs



Best choice for the most demanding coarse grit stripping, blending, and sanding applications

### BLAZE A995 NO-FIL CERAMIC ALUMINA

- P-graded, next-generation sharper-edged ceramic aluminum oxide abrasive ensures fastest cut rate and longest life of any paper disc
- Unique polyester-reinforced, D-weight latex saturated backing provides maximum tear strength while retaining flexibility
- Water-based, non-pigmented stearate No-Fil coating and open coat provide maximum load resistance and no color transfer to work



Best choice for the most demanding sanding applications

### DRYICE A975 NO-FIL CERAMIC ALUMINA

- P-graded seeded-gel ceramic alumina abrasive for fastest cut rate and longest life of any paper disc
- Unique fiber reinforced, flexible B or C-weight latex saturated backing delivers 50% - 60% improvement in tear strength while retaining flexibility
- Water-based, non-pigmented stearate No-Fil coating and open coat provide maximum load resistance and no color transfer to work



Better choice for high-performance dry finishing on all materials

### A2750P NO-FIL ALUMINUM OXIDE

- Premium P-graded, heat treated, toughened aluminum oxide abrasive delivers superior life, fast cut rate, consistent finish
- Unique fiber reinforced, flexible B-weight latex saturated backing provides 50% - 60% improvement in tear strength while retaining flexibility
- Water-based, non-pigmented stearate No-Fil coating and open coat provide maximum load resistance and no color transfer to work
- 5" and 6" individual PSA discs in fine grits have a tabbed, white translucent liner to protect the PSA adhesive from airborne contaminants; the tab allows easier removal of the paper liner



Better choice for hard-to-sand surfaces and wood applications

### DURITE A475 NO-FIL SILICON CARBIDE

- Sharp and hard, P-graded, silicon carbide abrasive easily penetrates the hardest material and veneers to create finer finishes where finish is critical
- Flexible, B-weight fiber reinforced, latex paper backing provides flexibility and resistance to tearing
- Water-based, non-pigmented stearate No-Fil coating and open coat provide maximum load resistance and no color transfer to work



Good choice for sanding a broad range of substrates including primed or painted surfaces, wood, composites, aluminum, and ferrous metals

### GOLD RESERVE A296 NO-FIL ALUMINUM OXIDE

- P-graded premium aluminum oxide abrasive produces a quick, cool cut and a more consistent surface finish
- Strong B-weight latex/paper backing resists tearing while staying conformable and flexible
- Water-based, non-loading (No-Fil) stearate coating minimizes clogging and increases disc life

### Lightweight Paper Discs

Stick & Sand (PSA)  
Lightweight Disc Rolls  
Non-Vacuum



TIER:	BEST	BETTER	BETTER	GOOD	GOOD
TRADENAME:	<b>DRYICE A975 NO-FIL</b>	<b>A2750P NO-FIL</b>	<b>DURITE A475 NO-FIL</b>	<b>GOLD RESERVE A296 NO-FIL</b>	<b>A290 NO-FIL</b>
ABRASIVE:	Ceramic Alumina	Aluminum Oxide	Silicon Carbide	Aluminum Oxide	Aluminum Oxide
PAPER BACKING WEIGHT:	B- & C-Weight	B-Weight	B-Weight	B-Weight	C-Weight
FASTENING:	PSA	PSA	PSA	PSA	PSA
OTHER:	P-Graded	P-Graded	P-Graded	P-Graded	P-Graded

SIZE	GRIT	ROLLS/ STD. PKG.	DISCS/ ROLL	PART #	PART #	PART #	PART #	PART #
3-1/2	80	4	100		662611 <b>36376</b>			
	120	4	100		662611 <b>36375</b>			
	180	4	100		662611 <b>36373</b>			
	220	4	100		662611 <b>36372</b>			
	280	4	100		662611 <b>36370</b>			
	320	4	100		662611 <b>36369</b>			
	400	4	100		662611 <b>36368</b>			
5	60	4	100					662611 <b>49831</b>
	80	4	100	662611 <b>40502</b>	662611 <b>131464</b> *	662544 <b>87415</b>	662611 <b>183806</b>	662611 <b>49830</b>
	100	4	100	662611 <b>40501</b>	662611 <b>131463</b> *	662544 <b>87417</b>	662611 <b>183807</b>	662611 <b>49829</b>
	120	4	100	662611 <b>40500</b>	662611 <b>131462</b> *	662544 <b>87418</b>	662611 <b>183808</b>	662611 <b>49828</b>
	150	4	100	662611 <b>40499</b>	662611 <b>131461</b> *	662544 <b>87440</b>	662611 <b>183809</b>	662611 <b>49827</b>
	180	4	100	662611 <b>40498</b>	662611 <b>131460</b> *	662544 <b>87441</b>	662611 <b>183810</b>	662611 <b>49826</b>
	220	4	100	662611 <b>42474</b>	662611 <b>131459</b> *	662544 <b>87442</b>	662611 <b>183811</b>	662611 <b>49825</b>
	240	4	100	662611 <b>55380</b>	662611 <b>131458</b> *	662544 <b>87443</b>		662611 <b>49824</b>
	280	4	100	662611 <b>55379</b>	662611 <b>131457</b> *			662611 <b>49823</b>
	320	4	100	662611 <b>55378</b>	662611 <b>131456</b> *	662544 <b>87444</b>	662611 <b>183813</b>	662611 <b>49822</b>
	400	4	100	662611 <b>55377</b>	662611 <b>131454</b> *	662610 <b>65293</b>	662611 <b>183814</b>	662611 <b>49821</b>
	500	4	100		662611 <b>131453</b> *			
	600	4	100	666233 <b>05608</b>	662611 <b>131452</b> *	662544 <b>21217</b>		
800	4	100	662544 <b>80230</b>	662611 <b>131451</b> *				
6	60	4	100					662611 <b>49847</b>
	80	4	100	662611 <b>40512</b>	662611 <b>131481</b> *	662544 <b>87446</b>	662611 <b>183815</b>	662611 <b>49842</b>
	100	4	100	662611 <b>40511</b>	662611 <b>131480</b> *		662611 <b>183816</b>	662611 <b>49841</b>
	120	4	100	662611 <b>40510</b>	662611 <b>131479</b> *	662544 <b>87447</b>	662611 <b>183817</b>	662611 <b>49840</b>
	150	4	100	662611 <b>40509</b>	662611 <b>131478</b> *		662611 <b>183818</b>	662611 <b>49839</b>
	180	4	100	662611 <b>40508</b>	662611 <b>131477</b> *	662544 <b>87448</b>	662611 <b>183819</b>	662611 <b>49838</b>
	220	4	100	662611 <b>48340</b>	662611 <b>131476</b> *	662544 <b>87449</b>	662611 <b>183820</b>	662611 <b>49837</b>
	240	4	100	662611 <b>55376</b>	662611 <b>131475</b> *		662611 <b>183821</b>	662611 <b>49836</b>
	280	4	100		662611 <b>131474</b> *			662611 <b>49835</b>
	320	4	100	662611 <b>55374</b>	662611 <b>131473</b> *	662544 <b>87450</b>	662611 <b>183822</b>	662611 <b>49834</b>
	400	4	100	662611 <b>55373</b>	662611 <b>131471</b> *		662611 <b>183823</b>	662611 <b>49833</b>
	500	4	100	636425 <b>06198</b>	662611 <b>131470</b> *			
	600	4	100	636425 <b>06199</b>	662611 <b>131469</b> *		662610 <b>40261</b>	
800	4	100	636425 <b>06200</b>	662611 <b>131468</b> *		636425 <b>06164</b>		
8	80	4	100		662611 <b>131617</b>			
	120	4	100		662611 <b>131615</b>			
	150	4	100		662611 <b>131614</b>			
	180	4	100		662611 <b>131613</b>			
	220	4	100		662611 <b>131612</b>			
320	4	100		662611 <b>131609</b>				

\* Packaging Standards A275 = 6/100

Refer to the Sanding Accessories section for back-up pads and accessories.

### Lightweight Paper Discs

Stick & Sand (PSA)  
Lightweight Disc Rolls  
Vacuum



TIER: **BETTER**  
 TRADENAME: **A2750P NO-FIL**  
 ABRASIVE: Aluminum Oxide  
 PAPER BACKING WEIGHT: B-Weight  
 FASTENING: PSA  
 OTHER: P-Graded



TIER: **GOOD**  
 TRADENAME: **A290 NO-FIL**  
 ABRASIVE: Aluminum Oxide  
 C-Weight  
 PSA  
 P-Graded

Stick & Sand (PSA)  
Individual Discs  
Non-Vacuum



TIER: **BETTER**  
 TRADENAME: **A2750P NO-FIL**  
 ABRASIVE: Aluminum Oxide  
 PAPER BACKING WEIGHT: B-Weight  
 FASTENING: PSA Tabbed  
 OTHER: P-Graded

SIZE	GRIT	ROLLS/ STD. PKG.	DISCS/ ROLL	PART #	ROLLS/ STD. PKG.	DISCS/ ROLL	PART #
							
				5" x 5 Hole Die #3329			
5	60				4	100	662611 <b>30266</b>
	80	6	100	662611 <b>31498</b>	4	100	662611 <b>30265</b>
	100	6	100	662611 <b>31497</b>			
	120	6	100	662611 <b>31496</b>	4	100	662611 <b>30263</b>
	150	6	100	662611 <b>31495</b>	4	100	662611 <b>30262</b>
	180	6	100	662611 <b>31494</b>	4	100	662611 <b>30261</b>
	220	6	100	662611 <b>31493</b>	4	100	662611 <b>30260</b>
	240	6	100	662611 <b>31492</b>			
	320	6	100	662611 <b>31490</b>	4	100	662611 <b>30258</b>
	400	6	100	662611 <b>31488</b>			

SIZE	GRIT	MIN./ STD PKG.	PART #
5	1000	100/400	662611 <b>31450</b>
	1200	100/400	662611 <b>31449</b>
6	1000	100/400	662611 <b>31467</b>
	1200	100/400	662611 <b>31466</b>
	1500	100/400	662611 <b>31465</b>

SIZE	GRIT	ROLLS/ STD. PKG.	DISCS/ ROLL	PART #	ROLLS/ STD. PKG.	DISCS/ ROLL	PART #
							
				6" x 6 Hole Die #3333			
6	80	6	100	662611 <b>31515</b>	4	100	662611 <b>30276</b>
	100	6	100	662611 <b>31514</b>	4	100	662611 <b>30275</b>
	120	6	100	662611 <b>31513</b>	4	100	662611 <b>30274</b>
	150	6	100	662611 <b>31512</b>	4	100	662611 <b>30273</b>
	180	6	100	662611 <b>31511</b>	4	100	662611 <b>30272</b>
	220	6	100	662611 <b>31510</b>	4	100	662611 <b>30271</b>
	240	6	100	662611 <b>31509</b>			
	280	6	100	662611 <b>31508</b>			
	320	6	100	662611 <b>31507</b>	4	100	662611 <b>30268</b>
	400	6	100	662611 <b>31505</b>			
	600	6	100	662611 <b>31503</b>			

Refer to the Sanding Accessories section for back-up pads and accessories.

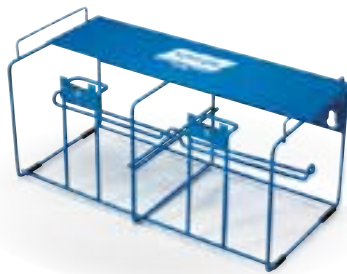

### PSA Disc Roll Dispenser

- Norton disc roll dispensers feature heavy-duty construction and a rubberized finish to protect your product, as well as the finish on your workpiece
- These versatile dispensers are designed to accommodate any 5" or 6" disc roll or sheet roll
- They can be attached to a wall or stacked for multi-grit or multi-diameter operations
- Discs are individually dispensed and removed from the roll by a cutter bar

DESCRIPTION	STD. PKG.	PART #
<b>PSA Disc Roll Dispenser</b>		
Single Disc Roll Dispenser	1	636425 <b>42772</b>
Double Disc Roll Dispenser (shown)	1	636425 <b>02981</b>

### Lightweight Paper Discs

Hook & Loop  
Individual Discs  
Non-Vacuum



TIER:	<b>BEST</b>	<b>BEST</b>
CAP CODE:	<b>BLAZE A995 NO-FIL</b>	<b>DRY ICE A975 NO-FIL</b>
ABRASIVE:	Ceramic Alumina	Ceramic Alumina
PAPER BACKING WEIGHT:	D-Weight	B- & C-Weight
FASTENING:	Hook & Loop	Hook & Loop
OTHER:	P-Graded	P-Graded

TIER:	<b>BETTER</b>	<b>BETTER</b>	<b>GOOD</b>	<b>GOOD</b>
CAP CODE:	<b>A2750P NO-FIL</b>	<b>DURITE A475 NO-FIL</b>	<b>GOLD RESERVE A296 NO-FIL</b>	<b>A290 NO-FIL</b>
ABRASIVE:	Aluminum Oxide	Silicon Carbide	Aluminum Oxide	Aluminum Oxide
PAPER BACKING WEIGHT:	B-Weight	B-Weight	B-Weight	C-Weight
FASTENING:	Hook & Loop	Hook & Loop	Hook & Loop	Hook & Loop
OTHER:	P-Graded	P-Graded	P-Graded	P-Graded

SIZE	GRIT	PKG/CASE	PART #	PART #	PKG/CASE	PART #	PART #	PART #	PART #
3	80				50/200	662611 <b>31532</b>			
	100				50/200	662611 <b>44926</b>			
	120				50/200	662611 <b>28688</b>			
	150				50/200	662611 <b>40385</b>			
	180				50/200	662611 <b>31528</b>			
	220				50/200	662611 <b>31527</b>			
	240				50/200	662611 <b>31526</b>			
	320				50/200	662611 <b>31524</b>			
	400				50/200	662611 <b>36995</b>			
	500				50/200	662611 <b>31521</b>			
	600				50/200	662611 <b>36996</b>			
	800				50/200	662611 <b>31519</b>			
	1000				50/200	662611 <b>35900</b>			
	1500				50/200	662611 <b>47434</b>			
	5	60				100/400			
80		50/200		662611 <b>40522</b>	100/400	662611 <b>31549</b>		666233 <b>77539</b>	662611 <b>49907</b>
100		50/200		662611 <b>40521</b>	100/400	662611 <b>31548</b>			662611 <b>49906</b>
120		50/200		662611 <b>40520</b>	100/400	662611 <b>31547</b>		666233 <b>77541</b>	662611 <b>49905</b>
150		50/200		662611 <b>40519</b>	100/400	662611 <b>31546</b>		666233 <b>77542</b>	662611 <b>49904</b>
180		50/200		662611 <b>40518</b>	100/400	662611 <b>31545</b>		666233 <b>77543</b>	662611 <b>49903</b>
220		50/200		662611 <b>49541</b>	100/400	662611 <b>31544</b>		666233 <b>05637</b>	662611 <b>49902</b>
240		50/200		662611 <b>49540</b>	100/400	662611 <b>31543</b>			
280					100/400	662611 <b>31542</b>			
320		50/200		662611 <b>49538</b>	100/400	662611 <b>31541</b>		666233 <b>05638</b>	662611 <b>49900</b>
400		50/200		662611 <b>49537</b>	100/400	662611 <b>31539</b>	662610 <b>52270</b>	666233 <b>05639</b>	662611 <b>49899</b>
500		50/200		662544 <b>80233</b>	100/400	662611 <b>31538</b>			
600					100/400	662611 <b>31537</b>		662611 <b>05390</b>	
800		50/200		662544 <b>80232</b>	100/400	662611 <b>31536</b>	662610 <b>52267</b>	666233 <b>77544</b>	
1000					100/400	662611 <b>31535</b>	662610 <b>52254</b>		
1200				100/400	662611 <b>31534</b>				
1500				100/400	662611 <b>31533</b>				
6	80	50/200	636425 <b>97510</b>	662611 <b>40532</b>	100/400	662611 <b>31566</b>		636425 <b>06236*</b>	662611 <b>49916</b>
	100	50/200		662611 <b>40531</b>	100/400	662611 <b>31565</b>		636425 <b>06235*</b>	662611 <b>49915</b>
	120	50/200	636425 <b>97511</b>	662611 <b>40530</b>	100/400	662611 <b>31564</b>		636425 <b>06234*</b>	662611 <b>49914</b>
	150	50/200	636425 <b>97512</b>	662611 <b>40529</b>	100/400	662611 <b>31563</b>		636425 <b>06233*</b>	662611 <b>49913</b>
	180	50/200	636425 <b>97513</b>	662611 <b>40528</b>	100/400	662611 <b>31562</b>		636425 <b>06232*</b>	662611 <b>49912</b>
	220	50/200	636425 <b>97514</b>	662611 <b>49546</b>	100/400	662611 <b>31561</b>		636425 <b>06231*</b>	662611 <b>49911</b>
	240				100/400	662611 <b>31560</b>		636425 <b>06225*</b>	
	280				100/400	662611 <b>31559</b>			
	320	50/200		662611 <b>49543</b>	100/400	662611 <b>31558</b>		636425 <b>06230*</b>	662611 <b>49909</b>
	400	50/200		662611 <b>49542</b>	100/400	662611 <b>31556</b>		636425 <b>06229*</b>	662611 <b>49908</b>
	500	50/200		636425 <b>06202</b>	100/400	662611 <b>31555</b>		636425 <b>06228*</b>	
	600	50/200		636425 <b>06203</b>	100/400	662611 <b>31554</b>		636425 <b>06227*</b>	
	800	50/200		636425 <b>06204</b>	100/400	662611 <b>31553</b>		636425 <b>06226*</b>	
	1000	50/200		636425 <b>06375</b>	100/400	662611 <b>31552</b>	662610 <b>52255</b>		
	1200	50/200		636425 <b>06376</b>	100/400	662611 <b>31551</b>			
1500	50/200		636425 <b>06377</b>	100/400	662611 <b>31550</b>				
8	120				100/400	662611 <b>31662</b>			
	180				100/400	662611 <b>31661</b>			

Packaging Standards: PKG/CASE A296 = 50/250

Refer to the Sanding Accessories section for back-up pads and accessories.

### Lightweight Paper Discs

Hook & Loop  
Individual Discs  
Vacuum



		<b>BEST</b>		<b>BETTER</b>		<b>GOOD</b>		<b>GOOD</b>		<b>GOOD</b>	
		<b>DRY ICE A975 NO-FIL</b>		<b>A2750P NO-FIL</b>		<b>GOLD RESERVE A296 NO-FIL</b>		<b>A290 NO-FIL</b>		<b>A290 NO-FIL</b>	
		Ceramic Alumina		Aluminum Oxide		Aluminum Oxide		Aluminum Oxide		Aluminum Oxide	
		B- & C-Weight		B-Weight		B-weight		C-Weight		C-Weight	
		Hook & Loop		Hook & Loop		Hook & Loop		Hook & Loop		Hook & Loop	
		P-Graded		P-Graded		P-Graded		P-Graded		P-Graded	
SIZE	GRIT	PKG./CASE	PART #	PART #	PART #	PART #	PART #	PART #	PART #	PART #	PART #
			5" x 5 Hole Die #3328	5" x 5 Hole Die #3328			5" x 5 Hole Die #3328	5" x 8 Hole Die #3392			
5	60	100/400					662611 <b>30236*</b>	662611 <b>30245*</b>			
	80	100/400	662611 <b>40517*</b>	662611 <b>31583</b>			662611 <b>30235*</b>	662611 <b>30244*</b>			
	100	100/400		662611 <b>31582</b>			662611 <b>30234*</b>	662611 <b>30243*</b>			
	120	100/400	662611 <b>40515*</b>	662611 <b>31581</b>			662611 <b>30233*</b>	662611 <b>30242*</b>			
	150	100/400		662611 <b>31580</b>			662611 <b>30232*</b>	662611 <b>30241*</b>			
	180	100/400		662611 <b>31579</b>			662611 <b>30231*</b>	662611 <b>30240*</b>			
	220	100/400		662611 <b>31578</b>			662611 <b>30230*</b>	662611 <b>30239*</b>			
	320	100/400		662611 <b>31575</b>			662611 <b>30227*</b>	662611 <b>30238*</b>			
	400	100/400		662611 <b>31573</b>			662611 <b>30226*</b>				
	600	100/400		662611 <b>31571</b>							
			6" x 6 Hole Die #3371	6" x 6 Hole Die #3371			6" x 6 Hole Die #3371	6" x 6 Hole Die #3371			
6	80	100/400	662611 <b>40527*</b>	662611 <b>31600</b>			666233 <b>34786*</b>	662611 <b>30255*</b>			
	100	100/400		662611 <b>31599</b>			666233 <b>34787*</b>				
	120	100/400		662611 <b>31598</b>			666233 <b>34788*</b>	662611 <b>30253*</b>			
	150	100/400		662611 <b>31597</b>							
	180	100/400		662611 <b>31596</b>			666233 <b>34790*</b>	662611 <b>30251*</b>			
	220	100/400		662611 <b>31595</b>			666233 <b>34791*</b>	662611 <b>30250*</b>			
	280	100/400		662611 <b>31593</b>							
	320	100/400		662611 <b>31592</b>			666233 <b>34793*</b>				
	400	100/400		662611 <b>31590</b>			666233 <b>34794*</b>				
	600	100/400		662611 <b>31588</b>			666233 <b>34796*</b>				
	800	100/400		662611 <b>31587</b>			666233 <b>34797*</b>				
	1000	100/400		662611 <b>31586</b>							
	1500	100/400		662611 <b>31584</b>							

Packaging Standards: \* A975 Vacuum, A296 Vacuum, A290 Vacuum = 50/200

Refer to the Sanding Accessories section for back-up pads and accessories.





**NEW**

An alternative to traditional perforated paper discs, mesh discs are a multi-functional abrasive, designed with thousands of holes, created by the unique mesh matrix structure. For use with random orbital and rotary sanders, superior performing mesh discs are engineered for maximum dust extraction on composite, automotive, and other fine finishing applications. Norton mesh discs produce superior finishes with virtually dust free sanding.

- Applications:** Surface preparation, Sanding, Finishing
- Size Range:** 5", 6"
- Grit Range:** 80-400
- Machine Used:**



ORBITAL SANDER

**Powerful Dust Extraction Means a Cleaner, Safer Work Environment**

We've answered the demands for a cleaner and safer working environment with Norton MeshPower discs. The open construction of the mesh backing allows dust particles to flow freely through the thousands of tiny holes, creating a virtually dust free sanding environment. Better for your health, better for your application and better for your business!

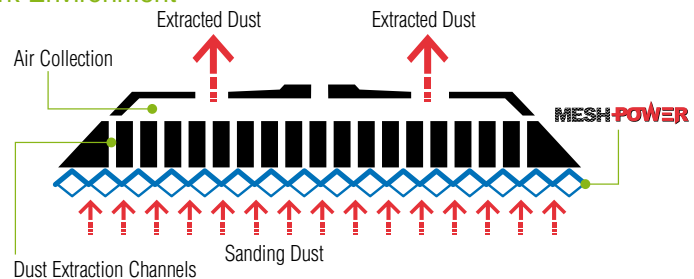

**NEW**

Good choice for sharp cutting along with powerful dust extraction

**MESHPower ALUMINUM OXIDE**

- Mesh matrix backing with thousands of tiny holes offers powerful dust extraction for a cleaner, healthier working environment
- Norton No-Fil technology prevents clogging and creates a consistent cut throughout the product life
- Self-grip backing with no designated hole pattern is quick and easy to align to any backing pad – just apply and go!

TIER: **GOOD**  
 TRADENAME: **MESHPower**  
 ABRASIVE: Aluminum Oxide

SIZE	GRIT	PKG./CASE	PART #
5	80	50/200	636425 <b>06451</b>
	120	50/200	636425 <b>06452</b>
	180	50/200	636425 <b>06453</b>
	220	50/200	636425 <b>06454</b>
	240	50/200	636425 <b>06455</b>
	320	50/200	636425 <b>06456</b>
6	400	50/200	636425 <b>06457</b>
	80	50/200	636425 <b>06458</b>
	120	50/200	636425 <b>06459</b>
	180	50/200	636425 <b>06460</b>
	220	50/200	636425 <b>06461</b>
	240	50/200	636425 <b>06462</b>
	320	50/200	636425 <b>06463</b>
	400	50/200	636425 <b>06464</b>

Contact your Norton representative for more information on additional grit sizes.

**TECH TIP**

Increase performance even further by using the Norton MeshPower discs with the Norton Multi-Air back-up pads - it's the ultimate dust extraction experience!



For use on random orbital and rotary sanders. The industry's highest performing film and foam finishing discs are engineered for composite, automotive, and other fine finishing applications. Norton microfinishing film discs produce superior finishes dry without sacrificing cut rate while Norton foam finishing discs are used moist to produce a semi-polished surface to reduce buffing time.

**Applications:**

Film discs: final dry finishing of primed and painted surfaces, varnishes, composites, and gel coats before buffing

Foam finishing discs: final moist finishing of clear coat, varnishes, composites, and gel coats before buffing

Compounds and buffing pads: removes swirl marks and sand scratches

**Size Range:**

3", 5" and 6"

**Grit Range:**

Film Discs: P80-P1500

Foam Discs: P1500, P2000, P3000

**Machine Used:**



ORBITAL SANDER



VERTICAL SHAFT PORTABLE GRINDER



MINI ANGLE SANDER

Finishing Film

**Best choice for final dry finishing of primed and painted surfaces, varnishes, composites, and gel coats**



**PURE ICE Q175 A/O FINISHING FILM**

- White aluminum oxide grain and patented resin system for better life, cut rate, and finish
- 3 mil polyester film backing for better flexibility and flatness of discs; hook and loop attachment for easy mounting and removal
- Color-coded backprint by grit size

**Good choice for dry sanding applications, especially uneven, hard-to-sand surfaces**



**Q275 NO-FIL A/O FINISHING FILM**

- Sharp, P-graded, heat-treated premium aluminum oxide grain ensures faster, yet cooler, cut for a longer life
- 3-mil polyester film backing delivers unmatched durability and tear strength with exceptional flatness for a flawless surface finish and reduced leveling and rework; hook and loop attachment for easy mounting and removal
- Water-based steared No-Fil coating provides maximum load resistance when sanding dry for extended life

Finishing Foam

**Best choice for moist finishing of clear coats, varnishes, composites, and gel coats**



**ICE Q255 A/O FINISHING FOAM**

- Premium, P-graded fine grit aluminum oxide grain
- Conformable, integrated foam backing eliminates pigtailed and costly rework; produces a semi-polished finished that can be quickly buffed out; hook and loop attachment
- Open mesh design distributes pressure evenly for quicker sanding and uniform scratch patterns
- Color coded abrasive face by grit size for easy grit identification



TIER:	BEST	GOOD
TRADENAME:	<b>PURE ICE Q175</b>	<b>Q275 NO-FIL</b>
ABRASIVE:	Aluminum Oxide	Aluminum Oxide
BACKING WEIGHT:	3 mil Polyester Film	3 mil Polyester Film
OTHER:	P-Graded	P-Graded

TIER:	BEST
TRADENAME:	<b>ICE Q255</b>
ABRASIVE:	Aluminum Oxide
BACKING WEIGHT:	Foam
OTHER:	P-Graded

SIZE	GRIT	PKG./CASE	COLOR	PART #	PART #	PKG./CASE	COLOR	PART #
3	P800	50/200	Black	776960 <b>88701</b>				
	P1000	50/200	Red	776960 <b>88702</b>				
	P1200	50/200	Green	776960 <b>88703</b>				
	P1500	50/200	Blue	776960 <b>88704</b>		6/24	Blue	636425 <b>06022</b>
	P2000					6/24	Magenta	636425 <b>06021</b>
	P3000					6/24	Green	636425 <b>06020</b>
5	P80	50/200			662611 <b>01614</b>			
	P120	50/200			662611 <b>01613</b>			
	P180	50/200			662611 <b>01610</b>			
	P220	50/200			662611 <b>01609</b>			
	P240	50/200			662611 <b>01608</b>			
	P320	50/200			662611 <b>01607</b>			
	P400	50/200			662611 <b>01606</b>			
	P600	50/200			662611 <b>01604</b>			
	P1200	50/200			662611 <b>01601</b>			
6	P80	50/200			662611 <b>01628</b>			
	P120	50/200			662611 <b>01627</b>			
	P180	50/200			662611 <b>01625</b>			
	P220	50/200			662611 <b>01624</b>			
	P320	50/200			662611 <b>01622</b>			
	P800	50/200	Black	776960 <b>88713</b>	662611 <b>01618</b>			
	P1000	50/200	Red	776960 <b>88714</b>	662611 <b>01617</b>			
	P1200	50/200	Green	776960 <b>88715</b>	662611 <b>01616</b>			
	P1500	50/200	Blue	776960 <b>88716</b>	662611 <b>01615</b>	15/60	Blue	636425 <b>06015</b>
	P2000					15/60	Magenta	636425 <b>06014</b>
	P3000					15/60	Green	636425 <b>06013</b>

Refer to the Sanding Accessories section for back-up pads and accessories.



Norton flexible diamond coated discs combine the durability and aggressiveness of diamond, on a flexible backing.

**Applications:**

Grinding ceramic, glass, composites, carbide and ceramic coatings, fiberglass, and reinforced plastics; removing rust and scale on other materials; producing metallurgical stamps and coupons

**Size Range:**

PSA (Pressure Sensitive Adhesive) Discs: 2" – 6"  
Quick-Change TR (Type III) Discs: 2" and 3"

**Grit Range:**

60 – 1500

**Abrasive Types:**

Diamond

**Backing Color:**

Color-coded backings for easily distinguished grit size selection

**Machine Used:**



ORBITAL SANDER



VERTICAL SHAFT PORTABLE GRINDER

Better choice for grinding glass, ceramics and composites, removing rust and scale, and producing metallurgical stamps and coupons

### D71S PSA DISCS

- Combines the durability and aggressiveness of a unique diamond abrasive face pattern with a flexible backing, to significantly increase life and lower costs versus standard coated and diamond discs
- Cloth backing provides strength, tear resistance, and flexibility
- Color-coded, PSA backing for quick, easy mounting and removal and identification of coarse grit sizes/applications

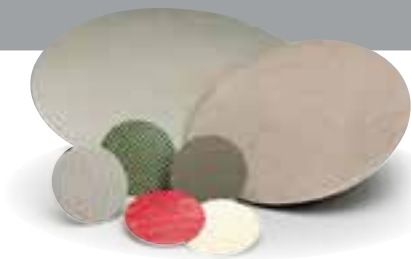

SIZE (D)	COLOR	GRIT	STD. PKG.	TIER: BETTER	
				PART #	
<b>Flexible Diamond Coated PSA Discs</b>					
2	Green	60	1	662603	<b>08159</b>
	Black	120	1	662603	<b>07722</b>
	Red	200	1	662603	<b>07723</b>
	Yellow	400	1	662603	<b>08160</b>
	White	800	1	662603	<b>07012</b>
5	Green	60	1	662603	<b>07839</b>
	Black	120	1	662603	<b>07838</b>
	Red	200	1	662603	<b>07019</b>
	Yellow	400	1	662603	<b>07960</b>

SIZE (D)	COLOR	GRIT	STD. PKG.	TIER: BETTER	
				PART #	
<b>Flexible Diamond Coated PSA Discs</b>					
6	Green	60	1	662603	<b>06381</b>
	Black	120	1	662603	<b>06382</b>

*See Page 70 – Coated Abrasive Cloth PSA Disc section for back-up pads.*

Better choice for improved cut rate and finish on ceramics, glass, fiberglass, composites, carbide, and other tough metals and coatings

### D7210 QUICK-CHANGE TR (TYPE III) DISCS

- Unique, durable diamond abrasive pattern increases life and lowers costs versus standard coated and diamond discs; color-coded backing for easy grit/application identification
- Better choice for improved cut rate and finish on ceramics, glass, fiberglass, composites, carbide, and other tough metals and coatings
- Removes rust and scale on other material; producing metallurgical stamps and coupons

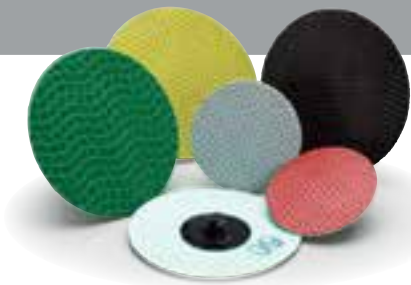

SIZE (D)	COLOR	GRIT	STD. PKG.	TIER: BETTER	
				PART #	
<b>Flexible Diamond Coated Quick-Change TR (Type III) Discs</b>					
2	Green	60	12	662603	<b>11778</b>
	Black	120	12	662603	<b>11779</b>
	Red	200	12	662603	<b>11780</b>
	Yellow	400	12	662603	<b>11781</b>
	White	800	12	662603	<b>11782</b>

SIZE (D)	COLOR	GRIT	STD. PKG.	TIER: BETTER	
				PART #	
<b>Flexible Diamond Coated Quick-Change TR (Type III) Discs</b>					
3	Green	60	12	662603	<b>11783</b>
	Black	120	12	662603	<b>11784</b>
	Yellow	400	12	662603	<b>11786</b>

*See Page 147 – Quick-Change Disc Accessories section for back-up pads.*

### Multi-Air Foam Interface Pads

- Designed for use with fine grit Multi-Air Cyclonic hook and loop sanding discs to improve both surface finish and cut rate
- Use with Multi-Air hook and loop disc back-up pads
- Align the interface pad with the Multi-Air back up pad then simply attach the disc to the interface pad because the holes do not have to be lined up
- Ideal for use with new Mesh discs



SIZE (D x T)	DESCRIPTION	STD. PKG.	PART #
<b>Multi-Air Foam Interface Pads with Vacuum Holes</b>			
5 x 1/2	Multi-Air Hook & Loop Interface Pad	8	636425 <b>85864</b>
6 x 1/2	Multi-Air Hook & Loop Interface Pad	12	076607 <b>19359</b>

### Multi-Air Hook & Loop Back-up Pads with Vacuum Holes

- Innovative design optimized for maximum air flow and powerful dust extraction
- Pads are engineered with a durable urethane foam, heat-resistant plastic, a molded-in 5/16"-24 spindle, and hooked face
- Holes in the disc do not have to be matched up with the holes in the pad, so changeover is fast and easy
- Ideal for use with new Mesh discs



SIZE (D)	DESCRIPTION	MAX. RPM	STD. PKG.	PART #
<b>Multi-Air Hook &amp; Loop Back-up Pads with Vacuum Holes</b>				
5" (125mm) with 5/16"-24 Shank	Medium-Density Urethane Pad	15,000	5	666233 <b>76000</b>
6" (150mm) with 5/16"-24 Shank	Medium-Density Urethane Pad	15,000	5	636425 <b>06160</b>

### Low-Profile Pads for Dual Action / Random Orbital Sanders

- Soft density low-profile pads utilize 1/2" thick foam for fine finish sanding and offer moderate conformability
- Medium low-profile pads have 1/2" thick urethane foam for intermediate and finish sanding
- Available with PSA (pressure sensitive adhesive) or hook and loop faces; both designs are shock resistant and have a fiberglass backing plate with a riveted 5/16"-24 threaded shank for added strength and increased heat resistance
- Available with standard hole patterns for vacuum-assist sanding



SIZE (D)	DESCRIPTION	MAX. RPM	STD. PKG.	PART #
<b>Low Profile Pads for DA/Random Orbital Sanders</b>				
3	Hook & Loop Soft Low-Profile	12,000	10	636425 <b>06128</b>
3-1/4	Hook & Loop Buffing Pad		5	662610 <b>85302</b>
5	PSA Soft Low-Profile	12,000	5	636425 <b>06126</b>
5	PSA Medium Low-Profile	15,000	5	636425 <b>06131</b>
5 x 5 holes	PSA Medium Low-Profile	15,000	5	636425 <b>06132</b>
5	Hook & Loop Soft Low-Profile	12,000	5	636425 <b>06129</b>
5	Hook & Loop Medium Low-Profile	15,000	5	636425 <b>06135</b>
5 x 5 holes	Hook & Loop Medium Low-Profile	15,000	5	636425 <b>06136</b>
6	PSA Soft Low-Profile	12,000	5	636425 <b>06127</b>
6	PSA Medium Low-Profile	15,000	5	636425 <b>06133</b>
6	Hook & Loop Soft Low-Profile	12,000	5	636425 <b>06130</b>
6	Hook & Loop Medium Low-Profile	15,000	5	636425 <b>06137</b>
6 x 6 holes	Hook & Loop Medium Low-Profile	15,000	5	636425 <b>06138</b>
8 x 8 holes, 5 screws	Hook & Loop Medium Low-Profile	1,500	5	636425 <b>43712</b>
8 x 8 holes, 6 screws	Hook & Loop Medium Low-Profile	1,500	5	636425 <b>43714</b>

*Packed in individual clamshell*

### Tapered Pads for Dual Action / Random Orbital Sanders

- Designed with medium density polyurethane foam and a tapered edge for conformability, these pads are firm enough for flat surfaces, yet soft enough for severe curves and contours
- Available with either PSA (vinyl, pressure sensitive adhesive) or hook and loop faces in vacuum or non-vacuum
- The 5" and 6" pads are shock resistant and have a fiberglass backing plate with a riveted 5/16"-24 threaded shank for use on random orbital or dual action sanders
- The 8" pads have a 5/8"-11 threaded female hub



SIZE (D)	DESCRIPTION	MAX. RPM	STD. PKG.	PART #
<b>Tapered Pads for DA/Random Orbital Sanders</b>				
5	PSA Medium Tapered	15,000	5	636425 <b>06139</b>
5 x 5 holes	PSA Medium Tapered	15,000	5	636425 <b>06140</b>
5	Hook & Loop Medium Tapered	15,000	5	636425 <b>06143</b>
5 x 5 holes	Hook & Loop Medium Tapered	15,000	5	636425 <b>06144</b>
6	PSA Medium Tapered	15,000	5	636425 <b>06141</b>
6 x 6 holes	PSA Medium Tapered	15,000	5	636425 <b>06142</b>
6	Hook & Loop Medium Tapered	15,000	5	636425 <b>06145</b>
6 x 6 holes	Hook & Loop Medium Tapered	15,000	5	636425 <b>06146</b>
8	PSA Medium Tapered	6,000	5	636425 <b>43112</b>
8	Hook & Loop Medium Tapered	3,200	5	636425 <b>43704</b>

*Packed in individual clamshell*

### Hook & Loop Foam Interface Pads

- Designed for use with our fine grit hook and loop sanding discs
- Improve both surface finish and cut rate
- Use with hook and loop back-up pads



SIZE (D x T)	DESCRIPTION	STD. PKG.	PART #
<b>Foam Hook &amp; Loop Interface Pads</b>			
3 x 1/2	Interface Pad	10	636425 <b>05457</b>
6 x 1/2	Interface Pad	5	636425 <b>42089</b>
5 x 3.4	Interface Pad	2	636425 <b>02161</b>
6 x 3/4	Interface Pad	2	636425 <b>02162</b>

### Half Moon Hand Pad

- The unique half moon pad takes a standard 5" hook and loop disc folded in half, which adheres to the hooks on the pad face
- The straight edge of the pad allows the operator to sand corners, contours, narrow crevices and minute imperfections without over-sanding

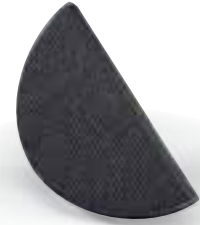

SIZE (D)	DESCRIPTION	STD. PKG.	PART #
<b>Half Moon Hand Pad</b>			
5	Hook & Loop	10	636425 <b>02768</b>

### Polishing Adapter Pad

- Converts your standard hook and loop pad into a soft polishing pad
- The foam adapter is 3/8" thick and is excellent for fine grits where minimal removal is required
- It is ideal for either flat or contour surfaces



SIZE	DESCRIPTION	MAX. RPM	STD. PKG.	PART #
<b>Polishing Adapter Pad</b>				
5	Hook & Loop Adapter Pad	3,786	10	636425 <b>03121</b>

### Ergonomic Hand Sanders

- The ergonomic palm sander is uniquely designed to be user-friendly, with finger indentations for the operator
- It quickly converts standard 5" and 6" hook and loop discs into hand sanders for finishing flat surfaces



SIZE (D)	DESCRIPTION	STD. PKG.	PART #
<b>Ergonomic Hand Sander</b>			
5	Hook & Loop	5	636425 <b>03147</b>
6	Hook & Loop	5	636425 <b>03726</b>

### Disc Hand Pads

- Hand pads eliminate finger sanding
- The ultra-thin 3/16" thick pad is composed of a single layer of neoprene foam and is designed for maximum flexibility – producing excellent finishes
- The 1" thick pad is composed of two layers, neoprene and polyester foam, for excellent conformability and softness, resulting in fine finishes
- Each pad has an elastic hand strap to hold it firmly in place
- Available with either PSA (vinyl, pressure sensitive adhesive) faces or hook and loop face



SIZE (D x T)	DESCRIPTION	STD. PKG.	PART #
<b>Disc Hand Pads</b>			
5 x 3/16	Soft Foam PSA	10	636425 <b>03111</b>
5 x 1	Soft Foam PSA	10	636425 <b>02842</b>
5 x 1	Soft Foam Hook & Loop	10	636425 <b>03117</b>

### Panel and Adhesive Cleaner

- Removes adhesives, tar, grease, wax, body sealers, undercoating sprays, and silicone from most surfaces
- Aggressive cleaner is safe to use on most paint applications
- Packaged with squirt dispenser
- Use as directed



SIZE/DESCRIPTION	STD. PKG.	PART #
<b>Panel and Adhesive Cleaner</b>		
Quart Can	12	076607 <b>82780</b>

### Liquid Ice Extra-Cut Compound

- Water soluble; easy to use and easy to clean up
- Engineered to be used with a selection of 3 pads, depending on the finish required



SIZE	DESCRIPTION	STD. PKG.	STD. CASE	PART #
Quart	Liquid Ice Extra-Cut Compound	1	4	636425 <b>97116</b>

### Liquid Ice Clean-up / Detailer Spray

- The spray detailer easily cleans up excess buffing residue and produces paint protection
- Spray it on and wipe off with a Norton Microfiber cloth ("Masking Products" section)



SIZE	DESCRIPTION	STD. PKG.	STD. CASE	PART #
32 oz.	Spray Bottle Clean-up Detailer	1	4	636425 <b>42082</b>

### Liquid Ice Ultra-Fine Machine Glaze

- Use on its own for fine scratch removal or as Step 3 in place of Norton Liquid Ice Extra-Cut Compound to eliminate swirl marks and produce a high gloss finish
- Ideal for dark-colored vehicles



SIZE	DESCRIPTION	STD. PKG.	STD. CASE	PART #
Quart	Liquid Ice Ultra-Fine Machine Glaze	1	4	636425 <b>06092</b>

### 8" Hook & Loop Buffing/Polishing Waffle Pads

- These pads can be used with Norton Liquid Ice Extra-Cut Compound

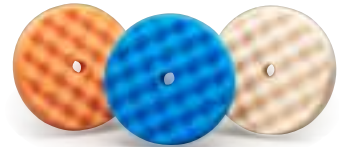

SIZE (D)	DESCRIPTION	STD. PKG.	STD. CASE	PART #
8	Orange Waffle Foam pad - Step 1	1	6	636425 <b>06379</b>
8	Blue Waffle Foam Pad - Step 2	1	6	636425 <b>06380</b>
8	White Waffle Foam Pad - Step 3	1	6	636425 <b>06381</b>

### 8" and 9" Hook & Loop Buffing/Polishing Pads

- These pads can be used with Norton Liquid Ice Extra-Cut Compound following the step numbers



SIZE (D)	DESCRIPTION	STD. PKG.	STD. CASE	PART #
8	Super Cut Wool Pad - Step 1	1	6	636425 <b>42077</b>
9	Blue Cutting Foam Pad - Step 2	1	6	636425 <b>42078</b>
9	White Finishing Foam Pad - Step 3	1	6	636425 <b>42079</b>

### 3" Hook & Loop Buffing/Polishing Pads

- For small spot repair



SIZE (D)	DESCRIPTION	STD. PKG.	STD. CASE	PART #
3	Super Cut Wool Pad - Step 1	10	40	636425 <b>43832</b>
3	Blue Cutting Foam Pad - Step 2	10	40	636425 <b>05459</b>
3	White Finishing Foam Pad - Step 3	10	40	636425 <b>05460</b>

### Hook & Loop Back-up Pads for 8" and 9" Buffing Pads

- Black plastic back-up plate with hook and loop face. Molded-in 5/8"-11 threaded female hub



SIZE (D)	DESCRIPTION	STD. PKG.	STD. CASE	PART #
8 and 9	Hook & Loop Back-up Pad	1	3	636425 <b>42080</b>

### Black Lambswool Hook & Loop Polishing Pads

- Distributing and applying material evenly and consistently, these dense, durable, lambswool pads are designed to repair clearcoat finishes



SIZE	DESCRIPTION	STD. CASE	PART #
3	Pad with Loop - 3/4" nap	40	636425 <b>03670</b>
4	Pad with Loop - 3/4" nap	250	636425 <b>03671</b>



Made from non-woven synthetic fiber mesh, which is impregnated with abrasives and bound with resins, non-woven wheels are designed to create desired surface finish where little or no stock removal is required. Non-woven wheels have an open mesh construction that is waterproof, washable, conformable and non-loading.

Non-Woven Convolute wheels are formed by wrapping and bonding web material impregnated with abrasive grain and resin around a center core.

**Applications:**

- Burr and flashing removal
- Surface roughness reduction
- Blending weld areas on stainless steel
- Blending scratch patterns
- Weld polishing
- Removing rust and oxides
- Applying decorative finishes including antique patterns

**Abrasive Grain:**

Aluminum Oxide, Silicon Carbide

**Grit Range:**

Medium (M), Fine (F), Very Fine (VF)

**Machine Used:**



BENCH GRINDER



PEDESTAL GRINDER

### Application/Grit Recommendation Guide

NORTON	Rapid Finish GP Convolute Wheels	Metal Finishing Convolute Wheels	Clean & Finish Convolute Wheels	Light Finishing Convolute Wheels
Scale Removal				
Stock Removal	Second Choice			
Heavy Deburring	Second Choice			
Decorative Finishing		Best Choice	Second Choice	
Blending	Best Choice	Second Choice		
Cleaning		Second Choice	Best Choice	
Light Deburring	Second Choice			Best Choice
Light Finishing	Second Choice			Best Choice
Polishing				Best Choice
Buffing				

### Surface Finish Variables

Changes in any one of many factors can affect the surface finish on the workpiece. This chart shows the effect on surface finish by changes in single factors of product specifications. Arrows have been used to signify the trend direction. The arrow length does not signify that the effect of each factor is equal.

Variable Factor	Rough Finish High RMS Reading	Smooth Surface Lower RMS Reading
1. Wheel Speed	Slow ←	Fast →
2. Feed Speed	Faster (Long Scratch) ←	Slower (Short Scratch) →
3. Oscillation	No Oscillation ←	Oscillation →
4. Lubricants	Dry ←	Water ← Soluble Oil ← Straight Oil → Compounds →

### Non-Woven Marking System

ABRASIVE	SILICON CARBIDE	ALUMINUM OXIDE		
	← SHARPER, FINER/BRIGHTER SCRATCH PATTERN	MORE DURABLE, LONGER LASTING, POLISHED FINISH →		
GRIT SIZE	XC (50)	C (60-80)	M (100-150)	F (180-220)
	← FASTER, AGGRESSIVE CUT, ROUGHER FINISH	REDUCED CUT RATE, FINER FINISH →		
DENSITY	2	9		
	← SOFT, OPEN, CONFORMABLE, LESS BURNING/LOADING	HARDER, MORE DURABLE, FASTER CUTTING, BETTER FINISH →		

### Cross Reference Guide

NORTON	BEST	BETTER	BETTER	GOOD	GOOD	GOOD
3M	Rapid Finish P 3M EXL, General Purpose	Series 1000 EXL Deburring	Metal Finishing Metal Finishing	Series 4000 EX2 & EX3	Light Finishing Light Deburring	Clean & Finish Multi Finishing
Standard	General Purpose Plus, Light Deburring	Deburring Convolute	Metal Finishing	GP Plus	LDW	Multi Finishing



Aggressive Deburring

Good choice for heavy deburring applications



SERIES 4000 ALUMINUM OXIDE & SILICON CARBIDE

- High-quality synthetic web provides long life for heavy deburring, edge-breaking, and parting line removal on exotic metals
- Advanced resin bond system ensures free cutting action
- Use both wet and dry

TIER: **GOOD**  
TRADENAME: **SERIES 4000**

SIZE (D x T x H)	ABRASIVE	GRIT	MAX. RPM	STD. PKG.	8 DENSITY PART #	9 DENSITY PART #
6 x 1/2 x 1	S/C	F	6,000	4		6626100 <b>4021</b>
6 x 1 x 1	A/O	M	6,000	3	6626100 <b>4208</b>	
	S/C	F	6,000	3	6626100 <b>4142</b>	6626100 <b>4141</b>
8 x 1 x 3	A/O	M	4,500	3	6626100 <b>4165</b>	
	S/C	F	4,500	3	6626100 <b>4123</b>	6626100 <b>4135</b>
12 x 1 x 5	S/C	F	3,000	2	6626100 <b>4284</b>	6626100 <b>4148</b>
12 x 2 x 5	S/C	F	3,000	1		6626100 <b>4011</b>

General Duty



NEW

Best choice for broad range of applications: general deburring, blending, and finishing on all materials including metals, wood, glass

RAPID FINISH GENERAL PURPOSE A/O & S/C

- Eliminate smearing and loading on a wide range of workpieces (from high-nickel-content alloys to aluminum and other soft metals with patent-pending Norton Clean Bond resin technology)
- Increase throughput with a 30% faster finish through new Norton grain/bond configuration, decrease wheel changes with a 10-30% longer life, provided by a new fiber and the high-temperature resin bond
- Ease wheel selection with color-coding wheel to match the primary use (maroon for General Purpose), and fiberglass core to match the abrasive (black for silicon carbide and white for aluminum oxide)

TIER: **BEST**  
TRADENAME: **RAPID FINISH GENERAL PURPOSE**

SIZE (D x T x H)	ABRASIVE	GRIT	MAX. RPM	STD. PKG.	PRODUCT CODE	6 DENSITY PART #	7 DENSITY PART #	8 DENSITY PART #	9 DENSITY PART #
6 x 1/2 x 1	A/O	M	6,000	4	C2315		662611 <b>34177</b>	662611 <b>34178</b>	662611 <b>34179</b>
	S/C	M	6,000	4	C4315				662611 <b>08076</b>
	S/C	F	6,000	4	C4415		662611 <b>33213</b>	662611 <b>06732</b>	662611 <b>12985</b>
6 x 1 x 1	A/O	M	6,000	3	C2315	662611 <b>34180</b>	662611 <b>34181</b>	662611 <b>34182</b>	662611 <b>34183</b>
	A/O	F	6,000	3	C2408	662611 <b>32100</b>	662611 <b>32322</b>	662611 <b>32324</b>	
	S/C	M	6,000	3	C4315		662611 <b>08074</b>	662611 <b>33215</b>	662611 <b>08075</b>
	S/C	F	6,000	3	C4415	662611 <b>14475</b>	662611 <b>19988</b>	636425 <b>77269</b>	636425 <b>81587</b>
	S/C	VF	6,000	3	C4515	662611 <b>31970</b>			
	S/C	M	6,000	2	C2315		662611 <b>34184</b>		
6 x 2 x 1	S/C	M	6,000	2	C4315		662611 <b>14471</b>		
	S/C	F	6,000	2	C4415		662611 <b>32325</b>		
	S/C	M	4,500	3	C4315		662611 <b>08066</b>	662611 <b>08069</b>	
8 x 1 x 3	S/C	F	4,500	3	C4415	662611 <b>08064</b>	662611 <b>08065</b>	636425 <b>53754</b>	636425 <b>76004</b>
	S/C	VF	4,500	3	C4515				662611 <b>33209</b>
	S/C	M	4,500	2	C4315		662611 <b>14473</b>		
8 x 2 x 3	S/C	F	4,500	2	C4415		662611 <b>14480</b>	662611 <b>14483</b>	662611 <b>14486</b>
	S/C	VF	4,500	2	C4515				662611 <b>33210</b>
	S/C	M	3,600	3	C2315		662611 <b>34185</b>		
10 x 1 x 5	S/C	F	3,600	3	C4415			662611 <b>06554</b>	662611 <b>14488</b>
	S/C	F	3,600	1	C4415			636425 <b>81044</b>	662611 <b>14489</b>
12 x 1 x 5	A/O	M	3,000	2	C2315				662611 <b>34186</b>
	S/C	F	3,000	2	C4415	662611 <b>08053</b>	662611 <b>14481</b>	662611 <b>14484</b>	662611 <b>14074</b>
	S/C	VF	3,000	2	C4515				662611 <b>34187</b>
12 x 2 x 5	S/C	F	3,000	1	C4415		662611 <b>14482</b>	662611 <b>12766</b>	662611 <b>14490</b>

General Duty *continued*



Better choice for general deburring, blending, and final finishing

### SERIES 1000 LONG LIFE A/O & S/C

- Offered in variety of web densities: more open, cool-cutting 7 density for light deburring, 8 to 9 density a good starting point for deburring, blending, polishing, and finishing
- Smear- and heat-free resin bond guarantees consistent, high-quality results; uniform grain dispersion and coating clean and condition without gouging or changing dimensions of workpiece
- Conformable and flexible for less operator fatigue

TIER: **BETTER**  
TRADENAME: **SERIES 1000 LONG LIFE**

SIZE (D x T x H)	ABRASIVE	GRIT	MAX. RPM	STD. PKG.	7 DENSITY PART #	8 DENSITY PART #	9 DENSITY PART #
6 x 1/2 x 1	A/O	M	6,000	4	662610 <b>18857</b>		662610 <b>18650</b>
	S/C	M	6,000	4			662610 <b>19540</b>
	S/C	F	6,000	4	662610 <b>18628</b>		662610 <b>18629</b>
6 x 1 x 1	A/O	M	6,000	3	699573 <b>97884</b>	662610 <b>18636</b>	662610 <b>19337</b>
	S/C	M	6,000	3	699573 <b>97882</b>	699573 <b>97883</b>	662610 <b>18630</b>
	S/C	F	6,000	3	662610 <b>18631</b>	662610 <b>18774</b>	662610 <b>18632</b>
8 x 1 x 3	A/O	M	4,500	3	699573 <b>97885</b>	662610 <b>18855</b>	662610 <b>18633</b>
	S/C	M	4,500	3	699573 <b>94610</b>	662610 <b>18673</b>	662610 <b>18997</b>
	S/C	F	4,500	3	662610 <b>18639</b>	662610 <b>18640</b>	662610 <b>18641</b>
12 x 1 x 5	A/O	M	3,000	2	699573 <b>97887</b>		662610 <b>18896</b>
	S/C	M	3,000	2		662610 <b>18786</b>	662610 <b>18908</b>
	S/C	F	3,000	2			662610 <b>18626</b>

Aesthetic Finishing



Better choice for decorative finishing, blending, and final finishing

### METAL FINISHING ALUMINUM OXIDE

- Premium, medium grit aluminum oxide grain generates uniform distinct satin and antique finishes
- Dense, very durable web allows these wheels to be used for blending applications; strong resin binder provides resiliency and long life
- Uniform grain dispersion and coating clean and condition without gouging or changing dimensions of workpiece

TIER: **BETTER**  
TRADENAME: **METAL FINISHING**

SIZE (D x T x H)	ABRASIVE	GRIT	DENSITY	MAX. RPM	STD. PKG.	PART #
6 x 1 x 1	A/O	M	5	6,000	3	662610 <b>07936</b>
	A/O	M	6	6,000	3	662610 <b>10148</b>
6 x 2 x 1	A/O	M	5	6,000	2	662610 <b>07957</b>
	A/O	M	6	6,000	2	662610 <b>09635</b>
8 x 1 x 3	A/O	M	5	4,500	3	662610 <b>07831</b>
8 x 2 x 3	A/O	M	5	4,500	2	662610 <b>07904</b>
	A/O	M	6	4,500	2	662610 <b>12971</b>
12 x 1 x 5	A/O	M	5	3,000	2	662610 <b>07434</b>
	A/O	M	6	3,000	2	662610 <b>09481</b>
12 x 2 x 5	A/O	M	5	3,000	1	662610 <b>07212</b>
14 x 2 x 8	A/O	M	5	2,550	1	662610 <b>07817</b>

Aesthetic Finishing *continued*

Good choice for light deburring, polishing, and fine finishing applications



## LIGHT FINISHING SILICON CARBIDE

- Advanced manufacturing process produces a consistent web and grain distribution for a consistent finish on intricate polishing applications
- Superior form holding for consistent, reliable edge breaking and finishing with minimal wheel dressing and reshaping; less dust and shedding with more uniform wear
- Controlled cut rate prevents “over benching”, deburrs and polishes without altering geometry

TIER: **GOOD**

TRADENAME: **LIGHT FINISHING**

SIZE (D x T x H)	ABRASIVE	GRIT	MAX. RPM	6 DENSITY PART #	7 DENSITY PART #	8 DENSITY PART #
6 x 1/2 x 1	S/C	F	6,000	662610 <b>92322</b>	662610 <b>92324</b>	662544 <b>21572</b>
6 x 1 x 1	S/C	F	6,000	662544 <b>03708</b>	662544 <b>03709</b>	662544 <b>21573</b>
8 x 1/2 x 3	S/C	F	4,500	662544 <b>03707</b>	662544 <b>09698</b>	662544 <b>21575</b>
8 x 1 x 3	S/C	F	4,500	662610 <b>95702</b>	662544 <b>09924</b>	662544 <b>21577</b>

All Light Finishing convolute wheels are non-stock. Ask your Norton representative for current lead-times and order quantities.

Good choice for fine finishing with light pressure



## CLEAN & FINISH SILICON CARBIDE

- Sharp, more aggressive silicon carbide abrasive leaves a fine/brighter scratch pattern
- Conformable to intricate shapes and contours without changing the workpiece dimension
- Open web construction makes these ideal for low-to moderate-pressure, low speed applications

TIER: **GOOD**

TRADENAME: **CLEAN & FINISH**

SIZE (D x T x H)	ABRASIVE	GRIT	DENSITY	MAX. RPM	STD. PKG.	PART #
4 x 1 x 1	S/C	M	4	4,000	10	662610 <b>58502</b>
		F	4	4,000	10	662610 <b>58501</b>
6 x 1 x 1	S/C	M	4	3,000	4	662610 <b>58507</b>
		F	4	3,000	4	662610 <b>58506</b>
6 x 2 x 1	S/C	M	4	3,000	2	662610 <b>58510</b>
		F	4	3,000	2	662610 <b>58509</b>
6 x 3 x 1	S/C	M	4	3,000	1	662610 <b>58512</b>
6 x 4 x 1	S/C	M	4	3,000	1	662610 <b>58514</b>
8 x 1 x 3	S/C	M	4	2,500	3	662610 <b>58518</b>
8 x 2 x 3	S/C	M	4	2,500	2	662610 <b>58521</b>
8 x 3 x 3	S/C	M	4	2,500	1	662610 <b>58524</b>
8 x 4 x 3	S/C	M	4	2,500	1	662610 <b>58526</b>

### Aluminum Reducing Bushings for Flap and Convolute Wheels



- Durable, aluminum one-piece-design flanges with integrated contact washer
- Snug fit; extended usable life
- Available in stock and non-stock sizes in many combinations of ID hole reduction

WHEEL CENTER HOLE	BUSHING REDUCES HOLE SIZE TO	FOR WHEEL DIAMETER	STD. PKG.	PART #
1	3/8	4 - 6	1 Pair	662610 <b>80522</b>
	1/2	4 - 6	1 Pair	662610 <b>80523</b>
	5/8	4 - 6	1 Pair	662610 <b>80524</b>
	3/4	4 - 6	1 Pair	662610 <b>80525</b>
	7/8	4 - 6	1 Pair	662610 <b>80526</b>
2	1/2	6	1 Pair	662610 <b>80527</b>
	5/8	6	1 Pair	662610 <b>80528</b>
3	1	6	1 Pair	662610 <b>80529</b>
	1-1/4	8	1 Pair	662610 <b>80531</b>
5	1	8	1 Pair	662610 <b>80532</b>
	1-1/4	10 and 12	1 Pair	662610 <b>80533</b>
	3	10 and 12	1 Pair	662610 <b>80534</b>
8	1-1/4	14	1 Pair	662610 <b>80535</b>

#### TECH TIP

- Convolute wheels must always run in the direction indicated by the arrow printed on the side of each wheel.
- Light to medium pressure is recommended. Excessive pressure may result in part damage.
- Lubricants such as water-soluble oil and straight oil will decrease the heat and improve the surface finish and lustre.



It is the user's responsibility to refer to and comply with ANSI B7.1

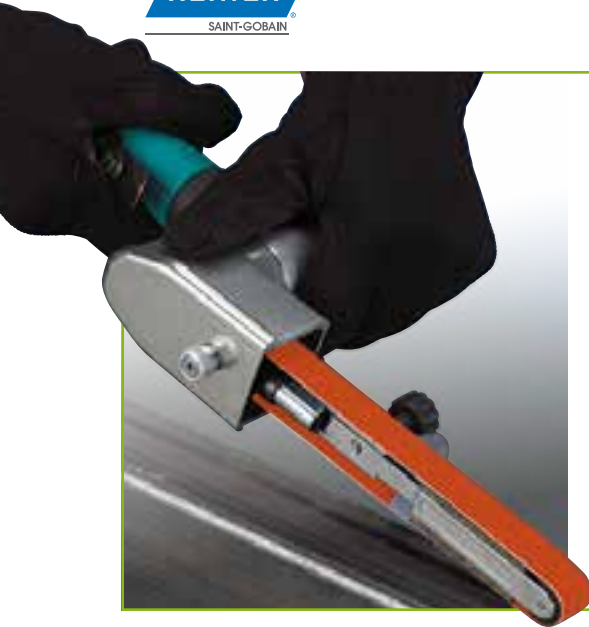

Portable file belt sanders have replaced tedious hand filing and sanding. First introduced in pneumatic, they are now also available in electric. Increasingly, tool manufacturers are introducing additional fixtures for additional applications. The belts listed are popular stock sizes, but additional sizes, specifications, backing materials, and edge scallops are available made-to-order.

**Applications:**

Light weld removal and blending, shape and contour sanding, surface preparation prior to coating and plating, removing cutting tool marks from molds and dies, general clean-up and finishing

**Size Range:**

1/8" to 1" wide, 12" to 30" long

**Grit Range:**

40 – 120

**Abrasive Grain:**

Ceramic Alumina, Zirconia Alumina, Aluminum Oxide

**Machine Used:**



PORTABLE FILE  
BELT SANDER

Cross Reference Guide

	BEST	BEST	BETTER	GOOD	GOOD
<b>NORTON</b>	<b>Blaze R980P</b>	<b>RedHeat R983</b>	<b>BlueFire R887D/R823P</b>	<b>Gemini R766</b>	<b>Gemini R283</b>
3M	963G/H, 966F, 967F, 997F, 984F, 784F, 947A	747D, 777F, 778F, 784F, 987F, 977F	577F, 551E	361F, 363F	241E, 244E, 251E, 261E
Hermes	CR456	—	RB48624YX, RB48644Z	RB377XY, SB378	RB530J, RB304J, RB306J
Klingspor	CS610	CS912	CS411X, CS416, CS409	CS412, CS413	CS412
SIA	2515, 2503	—	2800, 2803, 2815, 2829, 2824	—	—
VSM	XK875X, XK885Y, XK880Y	XK870X, XK870X	ZK713X, ZK713T, KK715X	LK719X, KK711X	KK711E
Sait	—	—	AZ-X	1AX, 2AX	LA-X
Sunmigh	—	—	—	P656W	—

Material-to-Product Recommendation Guide

	BEST	BEST	BETTER	GOOD	GOOD	
	Blaze R980P	RedHeat R983	BlueFire R887D	BlueFire R823P	Gemini R766	Gemini R283
Carbon Steel	◆	◆	◆	◆	◆	◆
Stainless Steel / Alloys	◆	◆	◆	◆	◆	◆
Cast Iron	◆	◆	◆	◆	◆	◆
Brass / Bronze	◆	◆	◆	◆	◆	◆
Aluminum	◆	◆	◆	◆	◆	◆



Best for stainless, cobalt, chrome, inconel, titanium, mild and carbon steel

BLAZE R980P CERAMIC ALUMINA

- Next-generation cooler cutting Norton SG ceramic alumina grain lasts 50% to 200% longer on mild and carbon steel, stainless, cobalt, chrome, inconel and titanium with better metal integrity
- Durable Y-weight polyester, waterproof cloth backing for improved grain adhesion, reduced edge-fray, and better body retention, resulting in longer life and product consistency
- Lubricating grinding aid coating means cooler cut, burn-free grinding of heat-sensitive materials, minimized loading, and improved part finish and integrity



Exceptional performance, especially on hard-to-grind alloys

REDHEAT R983 CERAMIC ALUMINA

- Premium ceramic abrasive provides sharp cutting, exceptional life and value, especially on hard-to-grind alloys
- "Supersize" grinding-aid for longer life, cooler cut and minimized loading
- Strong Y-weight polyester, waterproof cloth backing for improved grain adhesion, reduced edge-fray and better body retention, resulting in longer life and product consistency

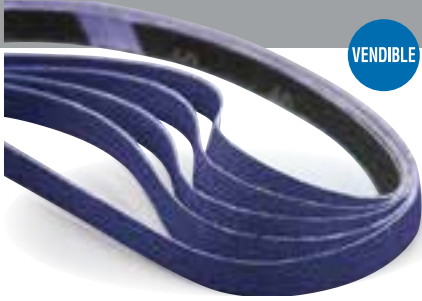

VENDIBLE

Better choice for stainless and carbon steel

## BLUEFIRE R887D/R823P ZIRCONIA ALUMINA

- Strong, self-sharpening zirconia alumina abrasive for fast, aggressive cut and 30% longer life than competitive zirconia belts
- Durable resin bond for excellent grain retention and product life
- Strong Y-weight polyester backing - R887D for heavy-duty stock removal applications; flexible X-weight polyester backing - R823P for moderate- to light-pressure applications



Good choice for difficult-to-grind materials (aluminum, brass, bronze, stainless, carbon steel, titanium, etc.)

## GEMINI R766 ALUMINUM OXIDE

- Premium aluminum oxide abrasive blend is ideal when primary purchasing criteria is a good-performing, economically-priced, general-purpose belt
- Y-weight waterproof polyester backing withstands light- to moderately-demanding applications and provides extended life on dry grinding applications
- Resin bond system provides improved edge retention and 30% plus improvement in life versus key competitors



Good choice for stainless and carbon steel applications when initial price is the primary purchasing factor

## GEMINI R283 ALUMINUM OXIDE

- P-graded premium aluminum oxide abrasive for consistent, cool cut
- Strong, semi-flexible, smooth X-weight rayon waterproof backing is designed for light- to moderate- pressure applications
- Durable resin coating provides excellent grain retention and product life



TIER:	BEST	BEST	BETTER	GOOD	GOOD
TRADENAME:	<b>BLAZE R980P</b>	<b>REDHEAT R983</b>	<b>BLUEFIRE R887D/R823P</b>	<b>GEMINI R766</b>	<b>GEMINI R283</b>
ABRASIVE:	Ceramic Alumina	Ceramic Alumina	Zirconia Alumina	Aluminum Oxide Blend	Aluminum Oxide
BACKING:	Y-Weight Polyester	Y-Weight Polyester	Y- or X-Weight Polyester	Y-Weight Polyester	X-Weight Rayon
OTHER:	Supersize	Supersize			

SIZE (W x L)	GRIT	STD. PKG.	PART #	PART #	PART #	PART #	PART #	
<b>12" Belts</b>								
1/8 x 12	40	50				666233	<b>90000</b>	
	60	50	662544	<b>05345</b>	662544	<b>91522</b>	662610	<b>93029</b>
	80	50			662544	<b>91523</b>		
	120	50	662544	<b>91519</b>	662544	<b>91524</b>		
1/4 x 12	40	50	662544	<b>91520</b>			666233	<b>90003</b>
	60	50	662611	<b>96480</b>		780727	<b>58896</b>	
	80	50			662544	<b>91526</b>	780727	<b>82621</b>
	120	50	662610	<b>63632</b>	662544	<b>91527</b>	780727	<b>82622</b>
1/2 x 12	40	50	699573	<b>98018</b>	662544	<b>91528</b>	662544	<b>92522</b>
	50	50	662610	<b>43759</b>	780727	<b>18700</b>	666233	<b>90006</b>
	60	50	699573	<b>98019</b>	780727	<b>18701</b>	780727	<b>28745</b>
	60	25 V					666233	<b>90008</b>
	80	50	699573	<b>98020</b>	780727	<b>18702</b>	780727	<b>28744</b>
	80	25 V					666233	<b>73753</b>
	100	50	662610	<b>1081180</b>	662544	<b>91529</b>	662544	<b>91534</b>
	120	50	662610	<b>42909</b>	780727	<b>00518</b>	780727	<b>28742</b>
1 x 12	60	50	662610	<b>63641</b>			666233	<b>73755</b>
						780727	<b>53073</b>	780727

Additional sizes, grits and scalloped edge belts are available MTO (made-to-order). Contact your Norton representative for availability, order quantities and lead-times.

40 and 50 grit BlueFire belts are furnished in BlueFire R887D (Y-weight Polyester); 60-120 grits are supplied in BlueFire R823P (X-weight Polyester).

Joints - All belts are PG jointed; a butt joint joined with flexible tape for contour grinding.

V = Vendible package. Ideal for vending machines and small jobs. 5 belts per pack / 5 packs per carton. Order in multiples of 25.

continued



TIER:	BEST	BEST	BETTER	GOOD	GOOD
TRADENAME:	<b>BLAZE R980P</b>	<b>REDHEAT R983</b>	<b>BLUEFIRE R887D/R823P</b>	<b>GEMINI R766</b>	<b>GEMINI R283</b>
ABRASIVE:	Ceramic Alumina	Ceramic Alumina	Zirconia Alumina	Aluminum Oxide Blend	Aluminum Oxide
BACKING:	Y-Weight Polyester	Y-Weight Polyester	Y- or X-Weight Polyester	Y-Weight Polyester	X-Weight Rayon
OTHER:	Supersize	Supersize			

SIZE (W x L)	GRIT	STD. PKG.	PART #	PART #	PART #	PART #	PART #
<b>13" Belts</b>							
3/8 x 13	60	50	699573 <b>45359</b>	780727 <b>45459</b>	780727 <b>40295</b>	666233 <b>90011</b>	780727 <b>32112</b>
	80	50	699573 <b>92150</b>	780727 <b>74916</b>	780727 <b>36062</b>	666233 <b>90012</b>	780727 <b>71323</b>
<b>18" Belts</b>							
1/8 x 18	40	50	662544 <b>75211</b>		662544 <b>91535</b>	666233 <b>90014</b>	
	60	50	662610 <b>80010</b>		780727 <b>60595</b>	666233 <b>90015</b>	
	80	50	662610 <b>89120</b>	780727 <b>89083</b>	780727 <b>60595</b>		
	120	50	662544 <b>75215</b>	780727 <b>89084</b>	636425 <b>95221</b>		
1/4 x 18	40	50	662610 <b>27923</b>	662611 <b>98953</b>	662544 <b>92525</b>	666233 <b>90016</b>	662544 <b>91543</b>
	60	50	699573 <b>47249</b>	780727 <b>74684</b>	780727 <b>43583</b>	666233 <b>90017</b>	780727 <b>71000</b>
	60	25 V			666233 <b>73747</b>		
	80	50	699573 <b>46155</b>	780727 <b>03284</b>	780727 <b>53075</b>		780727 <b>73921</b>
	80	25 V			666233 <b>73748</b>		
	120	50	662610 <b>85071</b>	780727 <b>85655</b>	780727 <b>73764</b>		
1/2 x 18	40	50	699573 <b>98021</b>	780727 <b>66018</b>	662544 <b>44193</b>	666233 <b>90019</b>	780727 <b>27561</b>
	60	50	699573 <b>98022</b>	780727 <b>18704</b>	780727 <b>28569</b>	666233 <b>90020</b>	780727 <b>27560</b>
	60	25 V			666233 <b>73756</b>		
	80	50	699573 <b>98023</b>	780727 <b>18705</b>	780727 <b>28568</b>	666233 <b>90021</b>	780727 <b>27559</b>
	80	25 V			666233 <b>73757</b>		
	120	50	662610 <b>41384</b>	780727 <b>18706</b>	780727 <b>28567</b>		780727 <b>27558</b>
3/4 x 18	40	50	699573 <b>98027</b>	780727 <b>62476</b>	662544 <b>92526</b>	666233 <b>90022</b>	780727 <b>81797</b>
	60	50	699573 <b>98028</b>	780727 <b>45691</b>	780727 <b>09590</b>	666233 <b>90023</b>	780727 <b>39966</b>
	60	25 V			666233 <b>73762</b>		
	80	50	699573 <b>98029</b>	780727 <b>56309</b>	780727 <b>58953</b>	666233 <b>90024</b>	780727 <b>32289</b>
	80	25 V			666233 <b>73763</b>		
	120	25 V			666233 <b>73764</b>		
<b>20-1/2" Belts</b>							
3/4 x 20-1/2	40	50	699573 <b>98030</b>	780727 <b>14398</b>	662544 <b>57869</b>	666233 <b>90025</b>	780727 <b>27573</b>
	50	50	699573 <b>44982</b>	780727 <b>18714</b>	662544 <b>92527</b>	666233 <b>90026</b>	662544 <b>91544</b>
	60	50	699573 <b>98031</b>	780727 <b>18715</b>	780727 <b>28560</b>	666233 <b>90027</b>	780727 <b>27571</b>
	60	25 V			666233 <b>73765</b>		
	80	50	699573 <b>98032</b>	780727 <b>18716</b>	780727 <b>28559</b>	666233 <b>90028</b>	780727 <b>27570</b>
	80	25 V			666233 <b>73766</b>		
	100	50	662610 <b>55516</b>	780727 <b>71151</b>	662610 <b>38911</b>		780727 <b>27569</b>
	120	50	662610 <b>44755</b>	780727 <b>27380</b>	780727 <b>28557</b>		780727 <b>27575</b>
<b>24" Belts</b>							
1/4 x 24	40	50	662611 <b>98631</b>	780727 <b>47823</b>	662544 <b>73499</b>		662544 <b>01929</b>
	60	50	699573 <b>45451</b>	780727 <b>56534</b>	780727 <b>28552</b>	666233 <b>90030</b>	780727 <b>27548</b>
	60	25 V			666233 <b>73750</b>		
	80	50	636425 <b>96940</b>	780727 <b>18340</b>	780727 <b>67713</b>		
1/2 x 24	120	50	662610 <b>80367</b>	780727 <b>70718</b>	780727 <b>28550</b>		
	40	50	699573 <b>98024</b>	780727 <b>60092</b>	662544 <b>92528</b>	666233 <b>90032</b>	780727 <b>27568</b>
	50	50	662610 <b>43757</b>	780727 <b>18707</b>	662544 <b>52237</b>	666233 <b>46910</b>	780727 <b>27567</b>
	60	50	699573 <b>98025</b>	780727 <b>18708</b>	780727 <b>28564</b>	666233 <b>90033</b>	780727 <b>27566</b>
	60	25 V			666233 <b>73759</b>		
	80	50	699573 <b>98026</b>	780727 <b>18709</b>	780727 <b>28566</b>	666233 <b>90034</b>	780727 <b>27565</b>
	80	25 V			666233 <b>73760</b>		
	100	50	662610 <b>42203</b>	780727 <b>45021</b>	780727 <b>53076</b>		662544 <b>91545</b>
120	50	662610 <b>42565</b>	780727 <b>18710</b>	780727 <b>28565</b>		780727 <b>27564</b>	
1 x 24	40	50	699573 <b>50019</b>	662544 <b>91531</b>			
	50	50	699573 <b>44889</b>	780727 <b>10374</b>			662544 <b>91547</b>
	60	50	699573 <b>53375</b>				
	80	50	699573 <b>45419</b>	780727 <b>72209</b>	780727 <b>76498</b>	666233 <b>34206</b>	662610 <b>85068</b>
120	50	662610 <b>85067</b>	662544 <b>91532</b>	780727 <b>30029</b>		662610 <b>85069</b>	
<b>30" Belts</b>							
1 x 30	40	50	662610 <b>53470</b>		662544 <b>78257</b>	666233 <b>90038</b>	662611 <b>89958</b>
	60	50	699573 <b>45985</b>		780727 <b>28583</b>	666233 <b>90039</b>	662544 <b>91549</b>
	80	50	699573 <b>46105</b>	780727 <b>64439</b>	780727 <b>28582</b>	666233 <b>90040</b>	780727 <b>27579</b>
	120	50	662611 <b>93676</b>	780727 <b>81197</b>	780727 <b>66992</b>		780727 <b>27577</b>

Additional sizes, grits and scalloped edge belts are available MTO (made-to-order). Contact your Norton representative for availability, order quantities and lead-times.  
40 and 50 grit BlueFire belts are furnished in BlueFire R887D (Y-weight Polyester); 60-120 grits are supplied in BlueFire R823P (X-weight Polyester).

Joints - All belts are PG jointed; a butt joint joined with flexible tape for contour grinding.

V = Vendible package. Ideal for vending machines and small jobs. 5 belts per pack / 5 packs per carton. Order in multiples of 25.



Portable belts are ideal for all your metal and woodworking applications. Choose 36 – 50 grits for rough/heavy-duty applications, 60 – 100 for intermediate, and 100 – 220 for finishing/polishing applications.

The belts listed are popular stock sizes, but additional sizes, specifications, and backing materials, are available made-to-order.

**Applications:**

Grinding and finishing all metals, blending welds, sanding and finishing wood, glass seaming, and polishing

**Size Range:**

3" to 4" wide, 15-1/2" to 24" long

**Grit Range:**

36 – 220

**Abrasive Grain:**

Ceramic Alumina, Zirconia Alumina, Aluminum Oxide

**Machine used:**



BELT SANDER

IN-LINE DRUM SANDER

### Cross Reference Guide

	BEST	BETTER	GOOD
<b>NORTON</b>	<b>RedHeat R983</b>	<b>BlueFire R831</b>	<b>Gemini R215/ Metalite R255</b>
3M	747D, 777F, 778F, 784F, 987F, 977F	577F	240DZ, 340A, 340D
Hermes	—	RB480	RB320
Klingspor	CS912	CS411	LS309XH
Sait	—	Z-H	1A-X, 2A-X, AO-X, LA-X
SIA	—	2800, 2829, 2925	2920, 2928, 2921, 2951, 2925
VSM	XK870X, XK870X	ZK713X	KK504X, KP510E

### Material-to-Product Recommendation Guide

	BEST	BETTER	GOOD
	<b>RedHeat R983</b>	<b>Bluefire R831</b>	<b>Gemini R215</b> <b>Metalite R255</b>
Wood		◆	◆
Carbon Steel / Stainless Steel	◆	◆	
Brass / Bronze / Aluminum		◆	◆

#### Exceptional performance, especially on hard-to-grind alloys



### REDHEAT R983 CERAMIC ALUMINA

- Premium ceramic abrasive provides sharp cutting, exceptional life and value, especially on hard-to-grind alloys
- "Supersize" grinding-aid for longer life, cooler cut and minimized loading
- Strong Y-weight polyester, waterproof cloth backing for improved grain adhesion, reduced edge-fray and better body retention, resulting in longer life and product consistency

#### Better choice for stainless steel and wood



### BLUEFIRE R831 ZIRCONIA ALUMINA

- Premium, self-sharpening zirconia alumina abrasive provides superior cut on all surfaces, lasts substantially longer, and cuts faster than the next leading competitor in side-by-side comparisons
- Proprietary patented grain technology produces one of the finest scratch patterns in the industry for finer looking finish; open-coat design and strong Y-weight cotton backing for reduced loading and extended life
- Reversible butt splice allows belt to be used in either direction for longer life



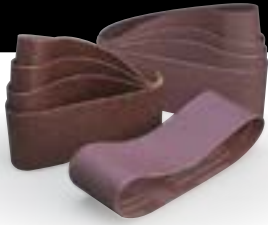

Good choice to minimize loading on wood and soft metals - where initial price is the main concern

## GEMINI R215 / METALITE R255 ALUMINUM OXIDE

- Premium aluminum oxide abrasive for fast initial cut rate
- Heavy, durable X-weight cotton backing is ideal for heat sensitive applications
- Strong butt joint that allows the belt to be run in either direction

### Portable Belts for Belt Sanders



TIER:	BETTER	GOOD
TRADENAME:	<b>BLUEFIRE R831</b>	<b>GEMINI R215</b>
ABRASIVE:	Zirconia Alumina	Aluminum Oxide
BACKING:	Y-Weight Cotton	X-Weight Cotton
JOINT:	Plyweld	Plyweld
GRAIN COATING:	Open Coat	Open Coat
OTHER:		



GOOD	GOOD
<b>GEMINI R215</b>	<b>METALITE R255</b>
Aluminum Oxide	Aluminum Oxide
X-Weight Cotton	X-Weight Cotton
Plyweld	Plyweld
Open Coat	Open Coat
	UPC Bar Coded

SIZE (W x L)	GRIT	PKG./CASE	PART #	PART #	STD. PKG.	PART #	PART #
3 x 18	36				5		780727 <b>80447</b>
	50	5/25*	076607 <b>49259</b>	076607 <b>00964</b>	10		780727 <b>27994</b>
	80	5/25*	076607 <b>49258</b>	076607 <b>00968</b>	10		780727 <b>27993</b>
	120	5/25*	076607 <b>49256</b>	076607 <b>00969</b>	10		780727 <b>27992</b>
3 x 21	36	5/25*	076607 <b>49266</b>	076607 <b>01741</b>			
	40				10		780727 <b>27927</b>
	50	5/25*	076607 <b>49265</b>	076607 <b>01740</b>	10		780727 <b>27926</b>
	60				10	780727 <b>27925</b>	
	80	5/25*	076607 <b>49264</b>	076607 <b>02064</b>	10		780727 <b>27924</b>
	100	5/25*	076607 <b>49263</b>		10		780727 <b>27923</b>
	120	5/25*	076607 <b>49262</b>	076607 <b>02062</b>	10		780727 <b>27922</b>
	220	5/25*		076607 <b>05287</b>			
3 x 24	36	5/25*	076607 <b>49272</b>	076607 <b>01743</b>	5		780727 <b>81847</b>
	40				10		780727 <b>27937</b>
	50	5/25*	076607 <b>49271</b>	076607 <b>01742</b>	10		780727 <b>27936</b>
	60				10	780727 <b>27935</b>	
	80	5/25*		076607 <b>02067</b>	10		780727 <b>27934</b>
	100	5/25*	076607 <b>49269</b>	076607 <b>02066</b>	10		780727 <b>27933</b>
	120	5/25*	076607 <b>49268</b>	076607 <b>02065</b>	10		780727 <b>27932</b>
	180	5/25*	076607 <b>49278</b>	076607 <b>01745</b>	5		780727 <b>80438</b>
4 x 24	36	5/25*	076607 <b>49278</b>	076607 <b>01745</b>	5		780727 <b>80438</b>
	40				10		780727 <b>27947</b>
	50	5/25*	076607 <b>49277</b>	076607 <b>01744</b>	10		780727 <b>27946</b>
	60				10	780727 <b>27945</b>	
	80	5/25*	076607 <b>49276</b>	076607 <b>02069</b>	10		780727 <b>27944</b>
	100	5/25*			10		780727 <b>27943</b>
	120	5/25*	076607 <b>49274</b>	076607 <b>02068</b>	10		780727 <b>27942</b>
	180	5/25*		076607 <b>05285</b>			

\*Job Pack packing standards: 5 belts/Job Pack; 5 Job Packs per case. Order by number of packs, in multiples of 5 packs.

### Portable Belts for Pneumatic In-Line Drum Sanders

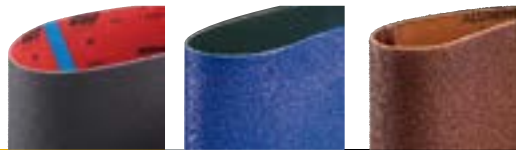

TIER:	BEST	BETTER	GOOD
TRADENAME:	<b>REDHEAT R983</b>	<b>BLUEFIRE R823P</b>	<b>GEMINI R215</b>
ABRASIVE:	Ceramic Alumina	Zirconia Alumina	Aluminum Oxide
BACKING:	Y-Weight Polyester	X-Weight Polyester	X-Weight Cotton
JOINT:	Plyweld	Plyweld	Plyweld
GRAIN COATING:	Closed Coat/Supersize	Closed Coat	Open Coat

SIZE (W x L)	GRIT	STD. PKG.	PART #	PART #	PART #
3-1/2 x 15-1/2	36	10	780727 <b>00783</b>		780727 <b>21997</b>
	60	10	780727 <b>18750</b>		780727 <b>22000</b>
	80	10	780727 <b>18751</b>	780727 <b>53074</b>	780727 <b>21995</b>
	120	10	780727 <b>18753</b>		



A broad selection of sizes and grits for most dimensioning, intermediate grinding and polishing applications.

The belts listed are popular stock sizes, but additional sizes, specifications, and backing materials, are available made-to-order.

**Applications:**

Benchstand and Backstand Belts: grinding and deburring of all metals, heavy stock removal, blending, dimensioning and shaping, polishing.

Centerless, Conveyor and Platen Belts: intermediate grinding stainless and carbon, moderate-pressure applications, dimensioning and finishing.

**Size Range:**

1" to 10" wide, 36" to 132" long

**Grit Range:**

24 – 320

**Abrasive Grain:**

Ceramic Alumina, Zirconia Alumina, Aluminum Oxide

**Machine Used:**



BACKSTAND  
BELT GRINDER



BENCHSTAND  
GRINDER

### Cross Reference Guide

	BEST	BEST	BETTER	BETTER	BETTER	GOOD	GOOD
<b>NORTON</b>	<b>Blaze R980P</b>	<b>RedHeat R983</b>	<b>BlueFire R821P</b>	<b>BlueFire R823P</b>	<b>BlueFire R884P</b>	<b>Gemini R766</b>	<b>Gemini R228</b>
3M	963G/H, 966F, 967F, 997F, 984F, 784F, 947A	747D, 777F, 778F, 784F, 987F, 977F	—	551E	561D	361F, 363F	241D, 251D, 341D
Hermes	CR454, CR456	CN464	—	RB486 X, RB346, RB486	RB48024YX, RB48444Z, RB485Z	RB377XY, SB378, RB34MJ	RB320X, HSB
Klingspor	CS610	CS912	CS411X	CS411X, CS416	CS411	CS412, CS413	CS310
SIA	2515, 2503	—	—	—	2820	—	2918, 2928
VSM	XK875X, XK885Y, XK880Y	XK870X, XK870X	—	ZK713X, KK715X	KK716, ZK713T	LK719X, KK711X	KK511X, KK711

### Material-to-Product Recommendation Guide

	BEST	BETTER	BETTER	BETTER	GOOD	GOOD
	Blaze R980P	BlueFire R884P	BlueFire R823P	BlueFire 821P	Gemini R766	Gemini R228
Aluminum		◆	◆		◆	
Cast Iron	◆		◆		◆	
Brass / Bronze		◆	◆		◆	
Die Castings	◆		◆		◆	
Carbon Steel	◆		◆		◆	◆
Glass / Ceramics	◆			◆	◆	
Stainless Steel and Alloys	◆	◆	◆		◆	
Wood		◆			◆	

### Grit Selection Recommendation Guide

STOCK REMOVAL	INTERMEDIATE	FINISHING
24 – 50 grit	60 – 100 grit	120 – 320 grit

## TECH TIP

### Troubleshooting Guide

Problem	Correction	Problem	Correction
Loading	Decrease infeed pressure or belt speed	Belt breakage	Reduce belt tension
Shedding	Reduce applied pressure		Use less aggressive contact wheel
	Use a less aggressive contact wheel		Check tracking mechanism for belts tracking erratically
	Dress contact wheel if worn or damaged		
	Use entire surface of belt		



Best for mild and carbon steel, stainless, cobalt, chrome, inconel, titanium

## BLAZE R980P CERAMIC ALUMINA

- Next-generation cooler cutting Norton SG ceramic alumina grain lasts 50% to 200% longer on mild and carbon steel, stainless, cobalt, chrome, inconel and titanium with better metal integrity
- Durable Y-weight polyester, waterproof cloth backing for improved grain adhesion, reduced edge-fray, and better body retention, resulting in longer life and product consistency
- Lubricating grinding aid coating means cooler cut, burn-free grinding of heat-sensitive materials, minimized loading, and improved part finish and integrity



Exceptional performance, especially on hard-to-grind alloys

## REDHEAT R983 CERAMIC ALUMINA

- Premium ceramic abrasive provides sharp cutting, exceptional life and value, especially on hard-to-grind alloys
- "Supersize" grinding-aid for longer life, cooler cut and minimized loading
- Strong Y-weight polyester, waterproof cloth backing for improved grain adhesion, reduced edge-fray and better body retention, resulting in longer life and product consistency



Better choice for heaviest-pressure applications

## BLUEFIRE R821P/R823P/R884P ZIRCONIA ALUMINA

- Strong, self-sharpening zirconia alumina abrasive for fast, aggressive cut and 30% longer life than competitive zirconia belts
- Durable resin bond for excellent grain retention and product life
- R821P Y-weight cotton backing provides durability and even wear on coarser grit stock removal applications;
- R823 has flexible X-weight polyester waterproof backing to excel on light- to moderate-pressure, applications
- R884P has a durable Y-weight polyester waterproof cloth backing that excels on medium- to high pressure applications



Good choice for difficult-to-grind materials (aluminum, brass, bronze, stainless, carbon steel, titanium, etc.)

## GEMINI R766 ALUMINUM OXIDE

- Premium aluminum oxide abrasive blend is ideal when primary purchasing criteria is a good-performing, economically-priced, general-purpose belt
- Y-weight waterproof polyester backing withstands light- to moderately-demanding applications and provides extended life on dry grinding applications
- Resin bond system provides improved edge retention and 30% plus improvement in life versus key competitors



Good choice for fine grit metalworking blending and polishing where initial price is the main concern

## GEMINI R228 ALUMINUM OXIDE

- Premium aluminum oxide abrasive delivers fast initial cut rate
- Heavy, durable X-weight cotton backing is ideal for heat sensitive applications
- Strong butt joint that allows the belt to be run in either direction

1" to 6" wide, 36" to 72" long



TIER:	BEST	BETTER	BETTER	GOOD	GOOD
TRADENAME:	<b>BLAZE R980P</b>	<b>BLUEFIRE R821P</b>	<b>BLUEFIRE R823P</b>	<b>GEMINI R766</b>	<b>GEMINI R228</b>
ABRASIVE:	Ceramic Alumina	Zirconia Alumina	Zirconia Alumina	Aluminum Oxide Blend	Aluminum Oxide
BACKING:	Y-Weight Polyester	Y-Weight Cotton	X-Weight Polyester	Y-Weight Polyester	X-Weight Cotton
OTHER:	Supersize				

SIZE (W x L)	GRIT	STD. PKG.	PART #	PART #	PART #	PART #	PART #
1 x 42	36	50	662544 <b>76825</b>				780727 <b>91710</b>
	40	50	699573 <b>45887</b>	780727 <b>26905</b>			780727 <b>20910</b>
	50	50	662544 <b>76826</b>	780727 <b>26904</b>		666233 <b>90042</b>	780727 <b>20905</b>
	60	50	699573 <b>45486</b>	780727 <b>26903</b>	780727 <b>28596</b>	666233 <b>34502</b>	780727 <b>20900</b>
	80	50	662610 <b>41539</b>	780727 <b>26902</b>	780727 <b>28594</b>	666233 <b>90043</b>	780727 <b>20895</b>
	100	50	662610 <b>43462</b>		780727 <b>28592</b>		780727 <b>20890</b>
	120	50	662610 <b>38660</b>		780727 <b>28590</b>		780727 <b>20885</b>
	150	50			780727 <b>28588</b>		780727 <b>20880</b>
	180	50			780727 <b>28586</b>		780727 <b>20875</b>
	220	50			780727 <b>00001</b>		780727 <b>20871</b>
	240	50					780727 <b>20870</b>
	320	50					780727 <b>20865</b>
	1-1/2 x 60	36	10	699573 <b>45578</b>			
40		10	636425 <b>95003</b>				
50		10					780727 <b>87807</b>
60		10	699573 <b>45631</b>			666233 <b>90045</b>	
80		10	699573 <b>45579</b>			666233 <b>90046</b>	
100		10			780727 <b>65077</b>		699573 <b>51736</b>
120		10	662610 <b>56493</b>		780727 <b>26984</b>		
2 x 48	24	10					780727 <b>26130</b>
	36	10	636425 <b>92057</b>	780727 <b>27103</b>		666233 <b>90047</b>	780727 <b>21255</b>
	40	10	699573 <b>45193</b>	780727 <b>27102</b>		666233 <b>90048</b>	780727 <b>21250</b>
	50	10	699573 <b>46716</b>	780727 <b>27101</b>			780727 <b>21245</b>
	60	10	699573 <b>44423</b>	780727 <b>27100</b>	780727 <b>28621</b>	666233 <b>90050</b>	780727 <b>21240</b>
	80	10	699573 <b>45100</b>	780727 <b>27099</b>	780727 <b>28619</b>	666233 <b>90051</b>	780727 <b>21235</b>
	100	10	662610 <b>52522</b>		780727 <b>28617</b>		780727 <b>21230</b>
	120	10	662610 <b>52520</b>		780727 <b>28615</b>		780727 <b>21225</b>
	150	10			780727 <b>28613</b>		780727 <b>23246</b>
	180	10			780727 <b>28611</b>		780727 <b>21223</b>
	220	10			780727 <b>28609</b>		780727 <b>63677</b>
	320	10					780727 <b>46387</b>
	2 x 60	24	10				
36		10	699573 <b>45196</b>			666233 <b>90052</b>	780727 <b>01170</b>
40		10	699573 <b>94425</b>	780727 <b>27124</b>			780727 <b>21300</b>
50		10	699573 <b>46149</b>				780727 <b>62537</b>
60		10	699573 <b>44901</b>	780727 <b>27122</b>		666233 <b>90055</b>	780727 <b>21290</b>
80		10	636425 <b>92574</b>	780727 <b>27121</b>		666233 <b>90056</b>	780727 <b>21285</b>
100		10	662610 <b>52222</b>		662610 <b>82976</b>		780727 <b>21280</b>
120		10	662610 <b>42738</b>		780727 <b>61958</b>		
150		10					780727 <b>44018</b>
180		10			780727 <b>02695</b>		780727 <b>20441</b>
220		10			780727 <b>06282</b>		780727 <b>44020</b>
240		10					780727 <b>61862</b>
320		10					780727 <b>02825</b>
2 x 72	24	10	662544 <b>33969</b>				
	36	10	699573 <b>45460</b>	780727 <b>27147</b>		666233 <b>90057</b>	780727 <b>21335</b>
	40	10	699573 <b>46729</b>	780727 <b>27146</b>		666233 <b>90058</b>	780727 <b>21332</b>
	50	10	699573 <b>44966</b>	780727 <b>27145</b>			780727 <b>84894</b>
	60	10	699573 <b>45157</b>	780727 <b>27144</b>	780727 <b>28645</b>	666233 <b>90060</b>	780727 <b>21325</b>
	80	10	699573 <b>44961</b>	780727 <b>27142</b>	780727 <b>28643</b>	666233 <b>34237</b>	780727 <b>21320</b>
	100	10	662610 <b>41897</b>		662610 <b>25537</b>		780727 <b>23235</b>
	120	10	662610 <b>44095</b>		780727 <b>28639</b>		780727 <b>21318</b>
	150	10			780727 <b>61770</b>		780727 <b>61973</b>
	180	10			780727 <b>63853</b>		780727 <b>18488</b>
	220	10			780727 <b>28633</b>		780727 <b>65601</b>
	320	10					780727 <b>21308</b>

\* Std. Pkg. = 20 Belts  
Continued

1" to 6" wide, 36" to 72" long *continued*

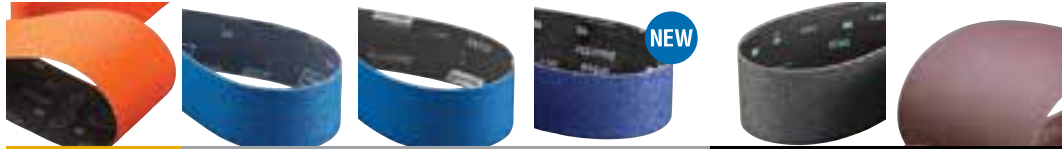

TIER:	BEST	BETTER	BETTER	BETTER	GOOD	GOOD
TRADENAME:	<b>BLAZE R980P</b>	<b>BLUEFIRE R821P</b>	<b>BLUEFIRE R823P</b>	<b>BLUEFIRE R884P</b>	<b>GEMINI R766</b>	<b>GEMINI R228</b>
ABRASIVE:	Ceramic Alumina	Zirconia Alumina	Zirconia Alumina	Zirconia Alumina	Aluminum Oxide Blend	Aluminum Oxide
BACKING:	Y-Weight Polyester	Y-Weight Cotton	X-Weight Polyester	Y-Weight Polyester	Y-Weight Polyester	X-Weight Cotton
OTHER:	Supersize					

SIZE (W x L)	GRIT	STD. PKG.	PART #	PART #	PART #	PART #	PART #	PART #	
2-1/2 x 48	36	10					666233 <b>90061</b>	780727 <b>21540</b>	
	50	10		780727 <b>27213</b>				780727 <b>21530</b>	
	60	10					666233 <b>90064</b>	780727 <b>21525</b>	
	80	10					666233 <b>90065</b>	780727 <b>21520</b>	
2-1/2 x 60	24	10				780727 <b>37759</b>		780727 <b>08296</b>	
	36	10	699573 <b>44963</b>	780727 <b>27235</b>			666233 <b>90066</b>	780727 <b>21610</b>	
	40	10	699573 <b>46523</b>	780727 <b>27234</b>			666233 <b>90067</b>	780727 <b>21605</b>	
	50	10	699573 <b>45300</b>	780727 <b>27233</b>			666233 <b>90068</b>	780727 <b>21600</b>	
	60	10	699573 <b>45002</b>	780727 <b>27232</b>	780727 <b>28692</b>	780727 <b>21383</b>	666233 <b>90069</b>	780727 <b>21595</b>	
	80	10	699573 <b>46095</b>	780727 <b>27231</b>	780727 <b>28690</b>		666233 <b>90070</b>	780727 <b>21590</b>	
	100	10	662610 <b>41380</b>		780727 <b>68991</b>			780727 <b>21585</b>	
	120	10			780727 <b>28686</b>			780727 <b>21580</b>	
	180	10			780727 <b>28682</b>			780727 <b>21570</b>	
	220	10			780727 <b>78217</b>			780727 <b>21565</b>	
4 x 36	36	10					666233 <b>90071</b>	780727 <b>22110</b>	
	40	10						780727 <b>22105</b>	
	50	10		780727 <b>27475</b>			666233 <b>90073</b>	780727 <b>22100</b>	
	60	10			780727 <b>28827</b>		666233 <b>90074</b>	780727 <b>22095</b>	
	80	10		780727 <b>27473</b>	780727 <b>28825</b>		666233 <b>90075</b>	780727 <b>22090</b>	
	100	10			780727 <b>28823</b>			780727 <b>22085</b>	
	120	10			780727 <b>28821</b>			780727 <b>22080</b>	
	150	10						780727 <b>22079</b>	
	180	10						780727 <b>22075</b>	
	240	10						780727 <b>22926</b>	
4 x 54	320	10						780727 <b>22071</b>	
	36	10						780727 <b>22185</b>	
	40	10						780727 <b>22180</b>	
	50	10					666233 <b>90078</b>	780727 <b>22175</b>	
	60	10	662610 <b>63419</b>	780727 <b>27518</b>	780727 <b>25116</b>			780727 <b>22170</b>	
	80	10	699573 <b>45139</b>		780727 <b>82996</b>			780727 <b>22165</b>	
	100	10						780727 <b>22160</b>	
4 x 60	120	10			780727 <b>28847</b>			780727 <b>22155</b>	
	150	10						780727 <b>28381</b>	
	24	10	662544 <b>61488</b>					780727 <b>72342</b>	
	36	10	699573 <b>45298</b>			780727 <b>37955</b>		780727 <b>05189</b>	
	40	10	699573 <b>91732</b>					780727 <b>44693</b>	
	50	10	699573 <b>46715</b>					780727 <b>61630</b>	
	60	10	636425 <b>94485</b>		780727 <b>74790</b>			780727 <b>62861</b>	
4 x 72	80	10	699573 <b>45099</b>		780727 <b>65086</b>			780727 <b>84685</b>	
	100	10						780727 <b>63161</b>	
	120	10	662544 <b>16188</b>		780727 <b>66229</b>			780727 <b>87840</b>	
	36	10				780727 <b>25984</b>			
	6 x 48	36	10	699573 <b>45143</b>	780727 <b>27698</b>			666233 <b>90081</b>	780727 <b>22590</b>
		40	10		780727 <b>27697</b>			666233 <b>90082</b>	
50		10		780727 <b>27696</b>			666233 <b>90083</b>	780727 <b>22580</b>	
60		10	699573 <b>44422</b>	780727 <b>27695*</b>	780727 <b>28937*</b>		666233 <b>90084</b>		
80		10		780727 <b>27694*</b>	780727 <b>28935*</b>		666233 <b>90085</b>	780727 <b>22570</b>	
100		10			780727 <b>28933*</b>			780727 <b>22565</b>	
120		10			780727 <b>28931*</b>			780727 <b>22560</b>	
150		10			780727 <b>70042</b>			780727 <b>22555</b>	
180		10						780727 <b>22550</b>	
220		10						780727 <b>22545</b>	
240		10						780727 <b>22540</b>	
320		10						780727 <b>22543</b>	

\* Std. Pkg. = 20 Belts  
Continued

1" to 6" wide, 36" to 72" long *continued*



TIER:	BEST	BETTER	BETTER	BETTER	GOOD
TRADENAME:	<b>BLAZE R980P</b>	<b>BLUEFIRE R821P</b>	<b>BLUEFIRE R823P</b>	<b>BLUEFIRE R884P</b>	<b>GEMINI R228</b>
ABRASIVE:	Ceramic Alumina	Zirconia Alumina	Zirconia Alumina	Zirconia Alumina	Aluminum Oxide
BACKING:	Y-Weight Polyester	Y-Weight Cotton	X-Weight Polyester	Y-Weight Polyester	X-Weight Cotton
OTHER:	Supersize				

SIZE (W x L)	GRIT	STD. PKG.	PART #	PART #	PART #	PART #	PART #
6 x 54	60	10				780727 <b>46982</b>	
6 x 60	36	10					780727 <b>22680</b>
	40	10		780727 <b>27762</b>			780727 <b>22679</b>
	60	10	699573 <b>45149</b>	780727 <b>28957*</b>			780727 <b>22665*</b>
	80	10			780727 <b>28955</b>		780727 <b>22660*</b>
	100	10	662544 <b>77452</b>				
	120	10					780727 <b>63882</b>

\* Std. Pkg. = 20 Belts

### Belt Cleaning Stick



- This solid, rubber cleaning stick is designed to remove wood and other non-metallic materials that build up on belt surface during use
- Apply it to the face of the belt, while running, to remove unwanted materials and prolong the overall life of the belt up to 10 times

DESCRIPTION	STD. PKG.	PART #
1-3/8 x 1-3/8 x 6	10	076607 <b>01717</b>

### TECH TIP

A light-bodied grease applied to a benchstand belt surface will reduce loading and greatly enhance the belt life and performance when grinding soft, malleable nonferrous materials such as aluminum, brass, bronze and copper.



For non-stock belts, FastTrack Service offers all the benefits of an ISO 9001 quality manufacturer and the advantages of a coated abrasives express belt service. As the industry's leading producer of abrasive material and backings, our FastTrack service offers an extensive range of Norton made-to-order belts including Blaze ceramic alumina, BlueFire zirconia alumina, and versatile aluminum oxide and silicon carbide belts.

Manufacturing Lead-times:

- Narrow belts: (1/2" – 12" wide) two days
- Wide belts (14" – 52" wide) three days

Size Availability:

- Maximum width: 52"
- 1/2" and greater widths; 25" and greater lengths

Please see the FastTrack Service Made-to-Order Belts section of this catalog for complete details.

2" to 10" wide, over 70" long

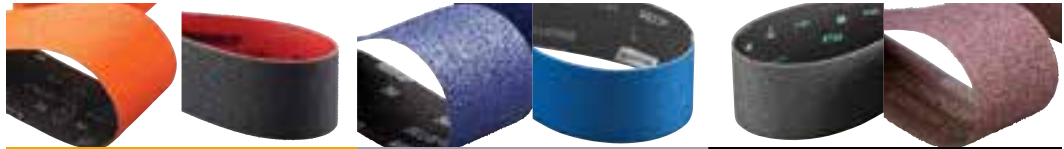

TIER:	BEST	BEST	BETTER	BETTER	GOOD	GOOD
TRADENAME:	<b>BLAZE R980P</b>	<b>REDHEAT R983</b>	<b>BLUEFIRE R884P</b>	<b>BLUEFIRE R823P</b>	<b>GEMINI R766</b>	<b>GEMINI R228</b>
ABRASIVE:	Ceramic Alumina	Ceramic Alumina	Zirconia Alumina	Zirconia Alumina	Aluminum Oxide Blend	Aluminum Oxide
BACKING:	Y-Weight Polyester	Y-Weight Polyester	Y-Weight Polyester	X-Weight Polyester	Y-Weight Polyester	X-Weight Cotton
OTHER:	Supersize	Supersize				

SIZE (W x L)	GRIT	STD. PKG.	PART #	PART #	PART #	PART #	PART #	PART #
2 x 132	36	10		780727 <b>53086</b>	780727 <b>50016</b>		666233 <b>47337</b>	
	40	10			780727 <b>50015</b>		666233 <b>90089</b>	
	50	10		780727 <b>40771</b>	780727 <b>50013</b>		666233 <b>90090</b>	
	60	10			780727 <b>50011</b>		666233 <b>90091</b>	780727 <b>21445</b>
	80	10		780727 <b>01958</b>	780727 <b>50008</b>		666233 <b>90092</b>	780727 <b>21440</b>
	120	10				780727 <b>28662</b>		
3 x 79	50	10	662610 <b>90276</b>					
	60	10			780727 <b>48280</b>			
3 x 90	36	10	699573 <b>46319</b>					780727 <b>85831</b>
3 x 132	24	10			780727 <b>50140</b>			
	36	10	699573 <b>44710</b>	780727 <b>53087</b>	780727 <b>50138 RR</b>		666233 <b>90093</b>	780727 <b>21900</b>
	36	10			780727 <b>50139 L</b>			
	40	10	699573 <b>44964</b>	780727 <b>01614</b>				
	50	10	699573 <b>44763</b>	780727 <b>03709</b>	780727 <b>50135</b>			780727 <b>21890</b>
	60	10	699573 <b>44958</b>			780727 <b>28794</b>	666233 <b>90096</b>	780727 <b>21885</b>
	80	10	699573 <b>44764</b>			780727 <b>28792</b>	666233 <b>90097</b>	780727 <b>21880</b>
	100	10				780727 <b>28790</b>		
	120	10				780727 <b>28789</b>		780727 <b>21870</b>
	180	10				780727 <b>28785</b>		780727 <b>21860</b>
4 x 79	36	10		662610 <b>22622</b>				
	40	10			780727 <b>74955</b>			
4 x 100	36	10			780727 <b>68679</b>			
4 x 132	24	10			780727 <b>50289</b>			
	36	10	699573 <b>43852</b>	780727 <b>39662</b>	780727 <b>50287</b>		666233 <b>26093</b>	
	40	10					666233 <b>90098</b>	
	60	10			780727 <b>50281</b>			
	80	10			780727 <b>50279</b>			780727 <b>22385</b>
	120	10						780727 <b>22375</b>
6 x 78-3/4	40	10			780727 <b>25150</b>			
6 x 79	36	10			780727 <b>38105</b>			
	80	10			780727 <b>79322</b>			
8 x 107	36	10						780727 <b>22795</b>
	50	10						780727 <b>49887</b>
	60	10						780727 <b>22780*</b>
	80	10						780727 <b>22775*</b>
10 x 70-1/2	36	10						780727 <b>22840</b>
	40	10						780727 <b>22835</b>
	50	10						780727 <b>22830</b>
	60	10					666233 <b>47345</b>	780727 <b>22825</b>
	80	10					666233 <b>47346</b>	780727 <b>22820</b>

\* Std. Pkg. = 20 Belts



A small selection of stock products in popular sizes are available for wide belt woodworking and metalworking applications.

**Applications:**

**Metalworking**

Metalworking wide belts are used for plate dimensioning, slag grinding, machining, deburring, and other general metalworking applications. They are usually cloth and are closed coat.

**Woodworking**

Cloth woodworking wide belts are used for rough stock removal and dimensioning  
Paper woodworking belts are used to upgrade the finish on furniture and other wood components.

**Size Range:**

Stock: 25" – 52" wide, 48" to 103" long

**Grit Range:**

Stock: 36 – 220

**Abrasive Grain:**

Zirconia Alumina, Aluminum Oxide

**Metalworking Cloth Belt Recommendation Guide/Cross Reference**

	TOTAL PERFORMANCE						INITIAL PRICE	
	BEST		BETTER		GOOD			
	H-wt. Polyester	Y-wt. Polyester	H-wt. Polyester	Y-wt. Polyester	X-wt. Polyester	Y-wt. Polyester	X-wt. Polyester	X-wt. Cotton
<b>NORTON</b>	<b>Blaze R940P</b>	<b>Blaze R980P</b>	<b>BlueFire R840P</b>	<b>BlueFire R887D/R884P</b>	<b>BlueFire R823P</b>	<b>Gemini R766</b>	<b>Gemini R766X</b>	<b>Gemini R228</b>
3M	966F, 984F, 994F, 997F	963G/H, 966F, 967F, 997F, 984F, 784F, 947A	561F	577F, 561D	551E	361F, 363F	353F, 384F	241D, 251D, 341D
Ekamant/ Uneeda	—	PS991, PS992	PZ628	PZ528, PZ633	XZ677	PA631, PG730, PG830	XA911	XA167
Hermes	CB441Z	CR456	SB488YR	RB48624YX, RB48644Z, RB48024YX, RB48444Z, RB485Z	RB486	RB377XY, SB378	RB377XY	RB320X, HSB
Klingspor	—	CS610	CS811	CS409, CS411	CS411X, CS416	CS412, CS413	CS341, CS710	CS310
SIA	—	2515, 2503	C888DP	2803, 2815, 2829, 2824, 2820	—	—	2820	2918, 2928
VSM	XK888Z, XK877Z	XK875X, XK885Y, XK880Y	KK717	KK716	ZK713X, ZK713T, KK715X	LK719X, KK711X	LK719X, KK711X	KK511X

**Woodworking Cloth and Paper Belt Recommendation Guide/Cross Reference**

	TOTAL PERFORMANCE			INITIAL PRICE		
	BEST		BETTER	GOOD		
	Y-wt. Cotton	F-wt. Paper	Y-wt. Cotton	X-wt. Cotton	F-wt. Paper	F-wt. Paper
<b>NORTON</b>	<b>Dust-Less SG R963</b>	<b>Dust-Less SG 975</b>	<b>BlueFire R831</b>	<b>Gemini R215</b>	<b>Dust-Less H295</b>	<b>Dust-Less H275</b>
3M	960G, 970DZ, 990FZ, 991FZ	966UZ	—	240DZ, 340A, 340D	260UZ	364UZ
Ekamant/ Uneeda	—	—	XZ677	RKX, RKXO	—	ARKFO, EKA1000, EKABlack
Hermes	—	CB115	RB480	RB320	BW114	BW110, BW114, CB115
Klingspor	—	—	C409, CS411	LS309XH	PS22	PS29
SIA	—	—	2803, 2820, 2829	2920, 2928, 2921, 2951	1919	1909, 1918, 1919 CRS, 1993
VSM	XK760X, XK760Y	XP760	KK713X, KK715X	KK504X, KP510E	KK508E	KP709, KP520, KP508E, KP510E



Better choice for all metal and wood applications due to the cut rate and life of the proprietary Norton BlueFire grain

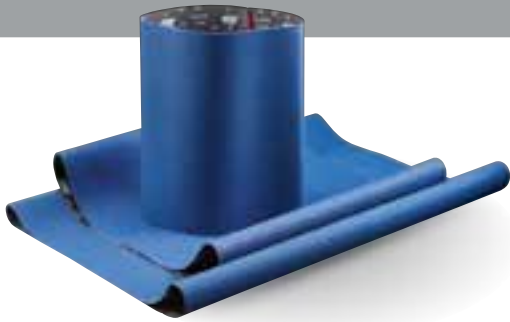

## BLUEFIRE R884P/R823P ZIRCONIA ALUMINA CLOTH

- Strong, self-sharpening zirconia alumina abrasive for fast, aggressive cut and 30% longer life than competitive zirconia belts
- Durable resin bond for excellent grain retention and product life
- R884P has a durable Y-weight polyester waterproof cloth backing that excels on medium- to high pressure metal applications
- R823 has flexible X-weight polyester waterproof backing to excel on light- to moderate-pressure metal applications

Good choice for abrasive planing and dimensioning of glued-up stock and banded particleboard



## GEMINI R215 ALUMINUM OXIDE CLOTH

- Premium aluminum oxide abrasive for fast initial cut rate
- Heavy, durable X-weight cotton backing is ideal for heat sensitive applications
- Strong butt joint that allows the belt to be run in either direction



TIER:	BETTER	BETTER	GOOD
TRADENAME:	<b>BLUEFIRE R884P</b>	<b>BLUEFIRE R823P</b>	<b>GEMINI R215</b>
ABRASIVE:	Zirconia Alumina	Zirconia Alumina	Aluminum Oxide
BACKING:	Y-Weight Polyester Cloth	X-Weight Polyester Cloth	X-Weight Cotton Cloth
JOINT/FLEX:	Plyweld, RR	Plyweld, RR	Plyweld, RR

SIZE (W x L)	GRIT	STD. PKG.	PART #	PART #	PART #
25 x 48	80	3		699573 <b>44781</b>	
25 x 60	80	3		699573 <b>28117</b>	
	120	5		699573 <b>28115</b>	
25 x 75	120	5		699573 <b>44791</b>	
36 x 75	36	2	699573 <b>50934</b>		
	60	3	699573 <b>50931</b>		
	120	5		699573 <b>29014</b>	
37 x 60	180	5		699573 <b>44869</b>	
	50	3	699573 <b>06219</b>		
	80	3		699573 <b>29019</b>	699573 <b>25709</b>
	100	5		699573 <b>28103</b>	699573 <b>25708</b>
37 x 75	120	5		699573 <b>29018</b>	699573 <b>25707</b>
	150	5		699573 <b>28102</b>	699573 <b>02955</b>
	180	5		699573 <b>28101</b>	
	220	5		699573 <b>28100</b>	
	36	2	699573 <b>50959</b>		
	50	3	699573 <b>05107</b>		
	80	3	699573 <b>50955</b>		699573 <b>25957</b>
52 x 75	100	5			699573 <b>23880</b>
	120	5		699573 <b>07358</b>	699573 <b>25760</b>
	150	5			699573 <b>05737</b>
	180	5		699573 <b>06734</b>	
	120	5		699573 <b>13510</b>	

Due to the wide varieties of machines and applications, the majority of wide belts are non-stock. Our FastTrack belt service is available on the majority of products with 3-day lead-time on orders up to two cases quantity.

**TECH TIP**

6" wide belts can be used on machines that normally use 37" wide belts.

# FastTrack Service Made-to-Order Belts

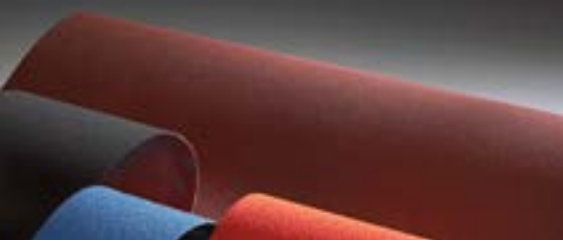

For many non-stock belts, our FastTrack belt service offers all the benefits of an ISO 9001 quality manufacturer and the advantages of a coated abrasives express belt service. As the industry leader of abrasive belts, our FastTrack belt service has an extensive range of Norton made-to-order belts including Blaze ceramic alumina, BlueFire zirconia alumina, versatile aluminum oxide, and silicon carbide belts.

Manufacturing lead-time is two days for narrow belts (1/2" – 12" wide) and three days for wide belts (14" – 52" wide). Please see the FastTrack belt service chart below for complete details on availability and lead-time.

## FastTrack Availability\* and Lead-time Information

WIDTH	GRIT SIZE	MINIMUM ORDER QUANTITY	CASE QUANTITY	MAXIMUM ORDER QUANTITY (EQUALS 2 CASES)	CONVERSION LEAD-TIMES
<b>Narrow Belts</b>					
1/2" through 1"	All	50	200	400	2
Over 1" through 5"	All	10	50	100	2
Over 5" through 9"	All	10	20	40	2
Over 9" through 14"	All	10	10	20	2
<b>Wide Belts</b>					
Over 14" through 20"	All	5	10	20	3
Over 20" through 52"	36 & coarser	2	2	4	3
Over 20" through 52"	40-80	3	3	6	3
Over 20" through 52"	100 & finer	5	5	10	3

\* FastTrack belt service applies to belts 25" and greater in length.

## How to Place a FastTrack Belt Order

- Check the FastTrack belt availability
- Include a full description of belt: quantity, size, Norton CAP code, and grit size
- Send order electronically, fax, or phone to customer service
- When ordering a belt that does not have an existing part number, please call Customer Service to expedite part number creation

TIER	PRODUCT CAP CODE	SHAPE AVAILABILITY	GRIT SIZE	ABRASIVE GRAIN	BACKING	APPLICATIONS
<b>Metalworking</b>						
Best	R980P	Narrow, Wide	24-120	Blaze Ceramic Alumina	Y-wt. Polyester	Latest-generation Norton SG grain, supersized and designed for high-performance grinding on stainless and other alloys
Best	R984	Narrow, Wide	36-120	SG Ceramic Alumina	Y-wt. Polyester	Norton SG grain for medium-pressure grinding and finishing heat-sensitive alloys
Best	R983	Narrow	P36-P120	Red Heat Ceramic Alumina	Y-wt. Plus	P-graded ceramic alumina abrasive with lubricating supersize coat; engineered for maximum productivity on mild carbon steel, ferrous metal, and cast iron applications
Better	R884P	Narrow, Wide	24, 36-80	BlueFire Zirconia Alumina	Y-wt. Polyester	High-performance zirconia alumina grain designed for medium- to high-pressure grinding
Better	R887D	Narrow, Wide	24, 36-120	BlueFire Zirconia Alumina	Y-wt. Polyester	High-performance zirconia alumina grain, supersized and designed for medium- to high-pressure grinding of heat-sensitive alloys
Better	R823P	Narrow, Wide	60-220	BlueFire Zirconia Alumina	X-wt. Polyester	High-performance zirconia alumina grain on lighter backing designed for light to medium grinding
Good	R766	Narrow	P24-80	Gemini Aluminum Oxide Blend	Y-wt. Polyester	Premium aluminum oxide blend product designed for a variety of applications including soft metals to hard-to-grind stainless and carbon steel
Good	R766X	Narrow, Wide	P60-P400	Gemini Aluminum Oxide Blend	X-wt. Polyester	Quality, P-graded aluminum oxide and broad grit range for stock removal to finer finishing
Good	MX240	Narrow, Wide	P80-P150	Aluminum Oxide	X-wt. Poly/Cotton	P-graded, heat-treated aluminum oxide X-weight cloth with strong, but flexible, cotton/ polyester backing making it an ideal multi-purpose product
Good	R245	Narrow	P80-P240, P320, P400	Aluminum Oxide	J-wt. Polyester	Aluminum oxide on flexible, lightweight polyester backing for moderate- to light- pressure applications on mild steel
Good	KF376	Narrow	P80-P320, P400, P600	Aluminum Oxide	J-wt. Cotton	P-graded, heat-treated aluminum oxide with ceramic coating on a very flexible backing for use wherever flexibility and conformability are needed
Good	R445	Narrow	60-220	Silicon Carbide	X-wt. Polyester	Sharp, silicon carbide grain on medium polyester backing for grinding very hard materials – glass, stone, solid surface
Good	U243	Narrow, Wide to 24"	X80, X65, X45, X30, X22, X16	NORaX Aluminum Oxide	J-wt. Cotton	High-performance, multi-layered NORaX grain on very flexible backing for dry polishing applications
<b>Woodworking</b>						
Best	R963	Narrow, Wide	24-60, P80 100-150	SG Ceramic Alumina	Y-wt. Polyester	Norton SG ceramic alumina grain with anti-static coating for forest product applications (MDF, particleboard, plywood)
Best	R955	Narrow	P36-P120	Red Heat Ceramic Alumina	Y-wt. Cotton	100% ceramic alumina abrasive with Y-weight cloth backing for dimensioning, intermediate sanding of wood
Better	R831	Narrow, Wide	24, 36-120	BlueFire Zirconia Alumina	Y-wt. Cotton	Norton BlueFire open-coat product recommended for dry low-pressure applications or where loading is a problem
Good	R215	Narrow, Wide	50-180	Gemini Aluminum Oxide	X-wt. Cotton	Initial starting specification for woodworking applications where loading is a problem, and initial cost a primary concern
Good	R490	Narrow, Wide	P36-P150	Silicon Carbide	Y-wt. Polyester	Anti-static product for forest product applications (MDF, particle board, plywood) where loading is an issue
Good	R422	Narrow	50-120	Silicon Carbide	X-wt. Cotton	Initial starting specification for woodworking applications where loading is not an issue
Best	H975	Narrow, Wide	60-220	Red Heat Ceramic Alumina	F-wt. Paper	Ceramic alumina grain, antistatic coating, and open coat; the best choice for applications where loading is a problem (soft woods, etc.)
Better	H831	Wide	24,36-120	BlueFire Zirconia Alumina	F-wt. Paper	Durable zirconia alumina grain, antistatic coating, and open coat: the better choice for applications where loading is a problem (soft woods, etc.)
Good	H275B	Narrow, Wide	P60-P220	Aluminum Oxide	F-wt. Paper	Quality aluminum oxide grain, antistatic coating, and open coat make these an economical choice for all heavy-weight paper belt jobs
Better	H475	Narrow, Wide	P120-P400	Onyx Silicon Carbide	F-wt. Paper	Sharp silicon carbide and antistatic coating create finer finishes on hard materials and veneers where finish is critical



Norton non-woven belts are a combination of strong synthetic mesh and quality abrasive, bonded together by a smear-resistant adhesive. The open construction of non-woven material enables aggressive cutting action and improved surface finish while maintaining its non-loading feature.

Watch for new and improved narrow belt and file belt joints.

**Applications:**

Removing surface defects, light edge burrs, parting lines, flashing, rust, oxides, corrosion, paints, and scale; blending mill marks, tool marks, uneven edges, and applying decorative finishes.

**Abrasive Grain:**

Engineered Aluminum Oxide, Aluminum Oxide

**Grit Range:**

Extra Coarse (Black), Coarse (Brown), Medium (Maroon), Fine (Green), Very Fine (Blue)

**Machine Used:**



### Application/Grit Recommendation Guide

	EXTRA COARSE	COARSE	MEDIUM	FINE	VERY FINE
	<b>BEST Choice - Vortex Rapid Prep</b>				
	<b>BETTER Choice - Rapid Prep</b>				
Scale Removal	◆				
Stock Removal		◆			
Heavy Deburring		◆			
Light Deburring			◆		
Light Finishing			◆		
Blending				◆	
Finishing					◆

### Vortex Rapid Prep Pump Sleeve Belts

Best choice for finishing and blending applications



## VORTEX RAPID PREP ALUMINUM OXIDE

- Patented Vortex agglomerated aluminum oxide grain produces the most consistent cutting and finishing action combining the cutting power of a coarser grit with the finish of finer grits
- Premium high-loft nylon fiber bonded to a strong nylon scrim backing allows a uniformly thick layer of resin bond and grain for extended life, durability, and stiffness
- Proprietary Clean Bond resin technology and open coat guarantee smear-free finishes even on high nickel content alloys and minimize loading on aluminum and other soft metals

	EXTRA COARSE	COARSE	MEDIUM	FINE	VERY FINE
GRIT/COLOR:	EXTRA COARSE	COARSE	MEDIUM	FINE	VERY FINE
TIER:	BEST	BEST	BEST	BEST	BEST
TRADENAME:	VORTEX RAPID PREP	VORTEX RAPID PREP	VORTEX RAPID PREP	VORTEX RAPID PREP	VORTEX RAPID PREP
ABRASIVE:	Engineered A/O	Engineered A/O	Engineered A/O	Engineered A/O	Engineered A/O
WIDTH	3-1/2	3-1/2	3-1/2	3-1/2	3-1/2
LENGTH	15-1/2	15-1/2	15-1/2	15-1/2	15-1/2
STD. PKG.	8	8	8	8	8
PART #	66623333725	66623335042	66623335118	66623333665	66623335139

Rapid Prep File and Narrow Belts

Better choice for finishing and blending applications



## RAPID PREP ALUMINUM OXIDE

- Premium aluminum oxide abrasive grain coating provides up to 20% higher cut rate versus other surface conditioning belts
- Durable nylon fiber bonded to a strong Y-weight polyester backing with extremely low stretch is ideal for applications where low-stretch and durability are necessary
- Proprietary Clean Bond resin technology and open coat guarantee smear-free finishes even on high nickel content alloys and minimize loading on aluminum and other soft metals

GRIT/COLOR:	EXTRA COARSE	COARSE	MEDIUM	FINE	VERY FINE
TIER:	BETTER	BETTER	BETTER	BETTER	BETTER
TRADENAME:	RAPID PREP	RAPID PREP	RAPID PREP	RAPID PREP	RAPID PREP
ABRASIVE:	Aluminum Oxide	Aluminum Oxide	Aluminum Oxide	Aluminum Oxide	Aluminum Oxide

WIDTH	LENGTH	STD. PKG.	PART #	PART #	PART #	PART #	PART #
<b>File Belts</b>							
1/4	18	24		66261011420	66261012524	66623333424	66623333511
	24	24		69957392606	66261097565	66623333425	66623333512
1/2	12	24		66261003177	66261006465	66623318175	66254499884
	18	24		66261055309	66261055310	66623333426	66261055311
	24	24		66261055312	66261008972	66254490859	66261019876
3/4	18	12		66261002111	66261015808	66254490858	66261003622
	20-1/2	12		66261083899	66261003260		66623333515
1	18	12		66261007023	66261017898	66623333429	66623333518
	21	12		66623333412	66623336005	66623333430	66623333519
<b>Narrow Belts</b>							
3/4	80	12		66623333411	66623333505	66623333428	66623333516
1	30	12		66261019801	66623336006	66623333431	66261001972
	42	12		66261008317	66254441289	66623333432	66623333521
	60	12					66261055412
	64	12		66623333414	66623301513	66623333434	66261055413
	72	12		66261194240	66261006378	66254493830	66261005583
	132	8		66623314981			
	132	10			66261011414	66254436886	66623333525
1-1/2	60	8		66623333415	66261007644		66623303624
2	18-15/16	12	66261018226		66623333507	66623333436	66623333528
	34	12		66261063309		66623333437	66623333529
	48	10		66261006504	66261006648	66623333438	66623333531
	60	8		66623333416	66261189669	66623333439	66623333532
	72	8		66261002571	66261007757	66623333440	66261002307
	132	6				66261069525	66623333533
2-1/2	60	6		66254429365	66254441491	66623333441	66623333534
2-3/4	15-1/2	10	66623333578	66623333417	66623333508		66623333535
3	10-11/16	12	66623333580	66261018076	66261067469	66623333443	66623333536
	18	10	66254428772	66254496043	66254428776	66623333444	66261019836
	21	10	66623333584	66623333418	66261010870	66623333445	66623333537
	24	10	66254433359	66623314158		66623333446	66261055593
	72	6		66623333419	69957396833	66623333447	66261003176
	80	4		66623333420	66261007149	66623333448	66623333542
	90	4		66623333421		66623333449	66623333541
	118	4		66623333422	66623333510	66623333450	66261047121
	132	4		66254490470	66261055322	66623333451	66623333543
	3-1/2	15-1/2	8	66623333595	66261055324	66254444576	66623333452
4	24	8	66623333596	66254495931	66261031667		
	36	6			66261002321	66623333454	66623333546
	132	2		66261009056	66261006898	66623333455	66623333547
	168	2		63642576650	66261009174	66623333456	66623333548
6	48	4		66261055330	66261055331	66623333457	66261055332

Most Narrow belts are also available in our Vortex grain. If you do not see the Rapid Prep belts you need in our stock offering contact your Norton Representative for made-to-order availability.



Engineered for flexibility and fast cutting, cloth sheets and rolls have a longer life than paper. They tear cleanly and straight without shedding and are packed in a protective dispenser to eliminate waste and damage.

**Categories:**

All purpose, fine finishing, and screen-back

**Applications:**

Scouring and light deburring, scale and rust removal, blending and fine sanding, polishing lathe turnings, rolls and cylinders, and blending machine tool marks

**Size Range:**

Sheets: 9" x 11"  
Rolls: 1" x 10 yds., 1-1/2" – 2" x 25 yds., 1" – 4" x 50 yds.

**Grit Range:**

40 – 600, extra coarse, coarse, medium, fine

**Abrasive Grain:**

Aluminum Oxide, Silicon Carbide, Emery

**Machine Used:**

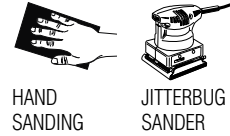

## Cross Reference Guide

	GOOD			
NORTON	Gemini K225	Metal R243	K622 Emery	Screen-Bak Q421
3M	011K	211K, 314D	011K, Emery Cloth	481W, 483W
Hermes	RB317	RB232J	—	GS91350, GS92400
Klingspor	LS309	KL361, LS309	KL371X	—
Sait/United Abrasives	DA-F	EA-F	—	Sait-Screen
SIA	2915	2601, 2915, 2936	1600, 2601	SIA-Screen
VSM	KK114F	KK505J, KK504X	—	—

## Application/Starting Recommendation Guide

Durability/Stock Removal	Conformability	Slower Cut	Waterproof
<b>Fast Cut</b>	<b>Excellent Finish</b>	<b>Fine Finish</b>	<b>Load Resistant</b>
Gemini K225	Metal R243	K622 Emery	Screen-Bak Durite Q421

Good choice for general-purpose metal and woodworking applications

## GEMINI K225 ALUMINUM OXIDE

- Premium P-graded aluminum oxide abrasive for greater cut rate on general purpose metalworking application
- Flexible J-weight backing for superior conformability to complex surfaces and better finishes
- Advanced full resin bond system for exceptional grain adhesion for longer life

Good choice for small-volume metal and woodworking applications at a low initial price

## METAL R243 ALUMINUM OXIDE

- Quality P-graded aluminum oxide abrasive grain delivers fast cut rate and consistent finish on metals
- Smooth, flexible J-weight cotton backing provides superior conformability to complex surfaces and better finishes
- Advanced full resin bond system provides exceptional grain adhesion for longer life on aluminum, fiberglass, composites, hard woods and soft woods



Good choice for removing rust, paint and scale from metal surfaces

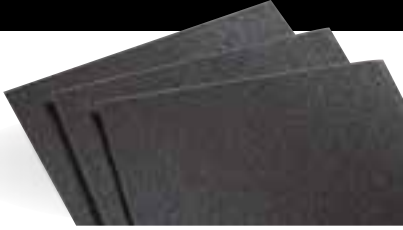

## K622 EMERY

- Natural emery abrasive for scouring and polishing non-rated metals and utensils
- Abrasive is durabonded onto a flexible cloth backing for durability
- Close coat for the greatest degree of stock removal and longest life

Good choice for sanding softer materials where loading is a major problem such as plastic, copper, brass, plaster, wood, and drywall

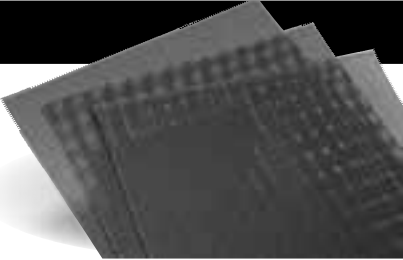

## SCREEN-BAK Q421 SILICON CARBIDE

- P-graded silicon carbide for excellent cutting and non-loading properties
- Open weave screen for extreme resistance to loading when removing scale, rust and corrosion
- Open mesh design is waterproof and washable, allowing you to rinse and reuse

### Cloth and Screen Rolls



TIER: <b>GOOD</b>		TIER: <b>GOOD</b>		TIER: <b>GOOD</b>		TIER: <b>GOOD</b>		TIER: <b>GOOD</b>	
TRADENAME: <b>GEMINI K225</b>		TRADENAME: <b>GEMINI K225</b>		TRADENAME: <b>GEMINI K225</b>		TRADENAME: <b>GEMINI K225</b>		TRADENAME: <b>GEMINI K225</b>	
ABRASIVE: Aluminum Oxide		ABRASIVE: Aluminum Oxide		ABRASIVE: Aluminum Oxide		ABRASIVE: Aluminum Oxide		ABRASIVE: Aluminum Oxide	
BACKING: J-Weight Cotton		BACKING: J-Weight Cotton		BACKING: J-Weight Cotton		BACKING: J-Weight Cotton		BACKING: J-Weight Cotton	
SIZE: 1" x 10 yds		SIZE: 1" x 50 yds		SIZE: 1-1/2" x 50 yds		SIZE: 2" x 50 yds		SIZE: 4" x 50 yds	
GRIT	STD. PKG.	PART #	PART #	PART #	PART #	PART #	PART #	PART #	PART #
40	1		66261058716+	66261058715+	66261058714+				
50	1		66261127728+	66261127730+	66261127732+				
60	1		66261127729+	66261127731+	66261127733+				
80	1	66261134298	66261126276	66261126288	66261126299				
100	1	66261134299	66261126275	66261126287	66261126298				
120	1	66261134300	66261126274	66261126286	66261126297			66261127285*	
150	1	66261134301	66261126273	66261126285	66261126296				
180	1	66261134302	66261126272	66261126284	66261126295				
220	1		66261126271	66261126283	66261126294				
240	1	66261134303	66261126270	66261126282	66261126293				
280	1		66261126269	66261126281	66261126292				
320	1	66261134304	66261126268	66261126280	66261126291				
400	1		66261126267	66261126279	66261126290				
600	1		66261126266	66261126278	66261126289				

+ 40 - 60 grit, are supplied in durable, but flexible X-weight cotton backing

\* Packaging Standards: 4" Roll Std. Pkg.: 6 rolls



TIER: <b>GOOD</b>		TIER: <b>GOOD</b>		TIER: <b>GOOD</b>		TIER: <b>GOOD</b>		TIER: <b>GOOD</b>	
TRADENAME: <b>METAL R243</b>		TRADENAME: <b>METAL R243</b>		TRADENAME: <b>METAL R243</b>		TRADENAME: <b>SCREEN-BAK Q421</b>		TRADENAME: <b>SCREEN-BAK Q421</b>	
ABRASIVE: Aluminum Oxide		ABRASIVE: Aluminum Oxide		ABRASIVE: Aluminum Oxide		ABRASIVE: Silicon Carbide		ABRASIVE: Silicon Carbide	
BACKING: J-Weight Cotton		BACKING: J-Weight Cotton		BACKING: J-Weight Cotton		BACKING: Mesh		BACKING: Mesh	
SIZE: 1" x 50 yds		SIZE: 1-1/2" x 50 yds		SIZE: 2" x 50 yds		SIZE: 1-1/2" x 25 yds		SIZE: 2" x 25 yds	
OTHER:						Waterproof		Waterproof	
GRIT	STD. PKG.	PART #	PART #	PART #	PART #	PART #	PART #	PART #	PART #
60	1	66261136178	66261136190	66261136203					
80	1	66261136179	66261136192	66261136204		66261107275*			
100	1	66261136180	66261136194	66261136205					
120	1	66261136181	66261136195	66261136206		66261107270*		66261149811*	
150	1	66261136182	66261136196	66261136207					
180	1	66261136186	66261136199	66261136208		66261107265*			
240	1	66261136187	66261136200	66261136209					
320	1	66261136188	66261136201	66261136210					
400	1	66261136189	66261136202	66261136211					

\* Packaging Standards: Screen-Bak Q421 Std. Pkg.: 10 rolls

## Cloth Sheets



TIER:	GOOD	GOOD	GOOD	GOOD
TRADENAME:	<b>GEMINI K225</b>	<b>METAL R243</b>	<b>K622 EMERY</b>	<b>SCREEN-BAK Q421</b>
ABRASIVE:	Aluminum Oxide	Aluminum Oxide	Emery	Silicon Carbide
BACKING:	J-Weight Cotton	J-Weight Cotton	J-Weight Cotton	Mesh
OTHER:				Waterproof

SIZE (W x L)	GRIT	PKG./CASE	PART #	PART #	PART #	PKG./CASE	PART #
9 x 11	40	25/125	66261 <b>058713+</b>				
	50	25/125	66261 <b>101862+</b>				
	60	25/125	66261 <b>101861+</b>				
	80	25/125	66261 <b>126340</b>	66261 <b>179998</b>		25/125	66261 <b>100960</b>
	100	50/250	66261 <b>126339</b>	66261 <b>181503</b>		25/125	66261 <b>100955</b>
	120	50/250	66261 <b>126338</b>	66261 <b>181504</b>		25/125	66261 <b>100950</b>
	150	50/250	66261 <b>126337</b>	66261 <b>181505</b>		25/125	66261 <b>100945</b>
	180	50/250	66261 <b>126336</b>	66261 <b>180005</b>		25/125	66261 <b>100940</b>
	220	50/250	66261 <b>126335</b>			25/125	66261 <b>100935</b>
	240	50/250	66261 <b>126334</b>	66261 <b>181507</b>			
	280	50/250	66261 <b>126333</b>				
	320	50/250	66261 <b>126332</b>	66261 <b>180006</b>		25/125	66261 <b>100920</b>
	400	50/250	66261 <b>126331</b>	66261 <b>181509</b>		25/125	66261 <b>100915</b>
	600	50/250	66261 <b>126330</b>				
	Extra Coarse	25/125					66261 <b>101255</b>
	Coarse	25/125					076607 <b>01307</b>
	Medium	50/250					076607 <b>01309</b>
	Fine	50/250					076607 <b>01308</b>

+ 40 - 60 grit are supplied in durable, but flexible X-weight cotton backing





Paper sheets and rolls are engineered for optimum performance when sanding metal, wood, composites and painted surfaces. The sheets are packed in protective packaging to eliminate waste and permit easy, neat storage.

**Categories:**  
**Applications:**

All purpose, wood sanding, stearated (non-loading), waterproof, and heavyweight  
Light-duty metal sanding, primer sanding, defect removal from painted surfaces, filler sanding, sanding and finishing of composites and fiberglass, bare wood sanding, sanding between sealer coats

**Size Range:**  
**Grit Range:**

Full Sheets, Cut Sheets, File Strips and Rolls  
36 – 2500

**Abrasive Grain:**

Ceramic Alumina, Zirconia Alumina, Aluminum Oxide, Silicon Carbide, and Garnet

**Paper Weights:**

Heavyweight – E; Lightweight – A through D

**Machine Used:**



## Material-to-Product Recommendation Guide

	BEST			BETTER			GOOD						
	Blaze A995	Dry Ice A975	A2750P	Black Ice T214	Black Ice T401	A259PS	Durite A475	Blue-Bak T414	Gold Reserve A296	PB273	Garnet	TufBak T461	Other
Unfinished Metal	◆	◆	◆						◆	◆			
Primed / Painted Surfaces / Between Coats	◆	◆	◆				◆		◆	◆			
Fiberglass / Composites	◆	◆	◆				◆		◆	◆			
Bare Wood	◆	◆	◆								◆		
											A511, A513, A514		
Clear Coat Sanding				◆	◆								◆
Sealer Sanding	◆	◆	◆				◆		◆	◆			
Lacquer Sanding				◆	◆			◆					◆
Wet Sanding				◆	◆			◆					◆
Paint Stripping	◆	◆	◆			◆	◆						A290
All Purpose	◆	◆	◆			◆							A212, A213, A211

## Cross Reference Guide

NORTON	3M	Hermes	Klingspor	Mirka	SIA	VSM
<b>STEARATED (NON-LOADING)</b>						
Blaze A995	732U, 737U, 755L, 775L	CR116	—	—	—	—
Dry Ice A975	334U	—	PS36	—	Siaprime 5550	—
A2750P	216U, 255L, 236U, 260L, 334U	VC154-LL	PS33, PS73W	Q-Silver, Royal Micro	1940, 1944, 1950	—
A259PS	216U, 255L, 236U, 260L, 334U	—	—	—	—	—
Durite A475	405N, 414N, 415U, 426U, 435U	SF168	PL35, PS14	CaratFlex, PolarStar	1748	CP131A
Gold Reserve A296 / PB273	216U, 236U, 316U, 315U, NX	VC154-LL	PS33, PS73W	Q-Silver, Royal Micro, Bulldog Gold	19,401,950	MP10
<b>WATERPROOF</b>						
Blue Ice T214	213Q	WAFlex28	—	—	1913, 1951, 1600	—
Blue Ice T401	401Q, 414Q, 486Q	WSFlex16	PL35	Waterproof (A)	—	CP918A
Blue-Bak T414	413Q	WSFlex 16	PS14	Waterproof (A)	—	CP918A/C
TufBak T461	431Q	WSFlex 18	PS14	—	1727	CP918A/C
<b>ALL PURPOSE/WOOD</b>						
A211	230U, 240N, 346U	—	—	—	—	—
A212	210N	—	PL31	—	—	—
A213	230N	—	PL31	—	—	—
Garnet A511	110N	—	PS10	—	1400	—
Garnet A513	130N	GCAB	—	—	—	—
Garnet A514	140N	GCAB	—	—	—	—
<b>HEAVYWEIGHT PAPER</b>						
BlueFire H875P	740I, 745I, 750U, 751U, 751I	BW110	PS36	Royal CRS. Cut	1820, 1919, 1948	KP510E, KP709



## Application/Grit Recommendation Guide

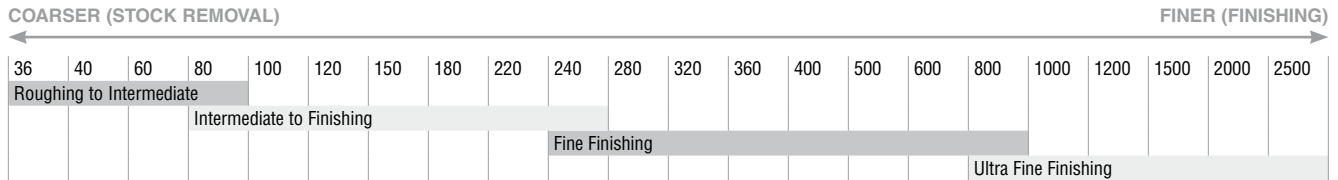

## Recommended Backing Weight

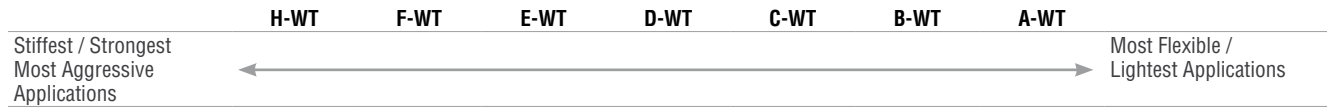

## Paper Rolls

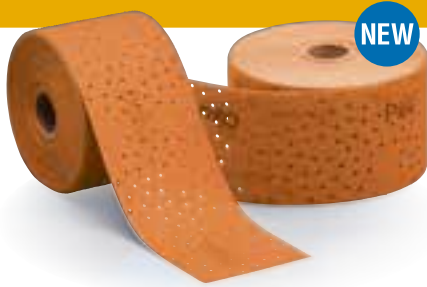

Best choice for fast cut rate and maximum dust extraction

### BLAZE A995 MULTI-AIR CYCLONIC CERAMIC ALUMINA

- P-graded next-generation ceramic aluminum oxide abrasive for fastest cut rate and longest life with innovative spiral hole design to optimize dust extraction
- Proprietary D-weight Polyester-reinforced, flexible latex-saturated backing for 100% improvement in tear strength and edge durability providing longer life in all applications
- Waterbased, non-loading (No-Fil) stearate resists clogging and increases roll life; hook and loop (NorGrip) back for easy mounting and changing



Best choice for the most demanding dry sanding applications

### DRYICE A975 CERAMIC ALUMINA

- P-graded, 100% SG ceramic alumina abrasive delivers fastest cut rate and longest life of any paper roll; available in Multi-Air Cyclonic version with laser-cut, spiral, vacuum-hole design to maximizes dust extraction
- Unique fiber reinforced, flexible B-wt. latex saturated paper backing for 50% - 60% improvement in tear strength while retaining flexibility; perforated for easy sizing
- Water-based non-pigmented stearate No-Fil coating provides improved load resistance and no color transfer to work



Better choice for high performance dry sanding applications

### A2750P ALUMINUM OXIDE

- Premium P-graded, heat treated, toughened aluminum oxide abrasive delivers superior life, fast cut rate, consistent finish
- Unique fiber reinforced, flexible B-weight latex saturated backing provides 50% - 60% improvement in tear strength while retaining flexibility
- Water-based, non-pigmented stearate No-Fil coating provides maximum load resistance; available in Multi-Air Cyclonic version for maximum dust collection

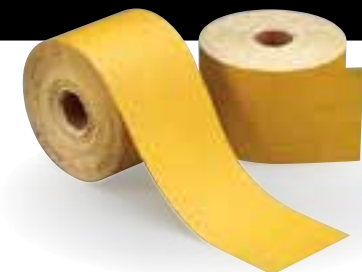

Good choice and value for dry sanding and finishing aluminum, fiberglass, composites, hard woods and soft woods

### A296 GOLD ALUMINUM OXIDE

- P-graded premium aluminum oxide abrasive produces a quick, cool cut and a more consistent surface finish
- Strong paper backing resists tearing while staying conformable and flexible
- Water-based, non-loading No-Fil stearate coating minimizes clogging and increases disc life

## Paper Rolls *continued*

Hook and Loop  
Paper Rolls

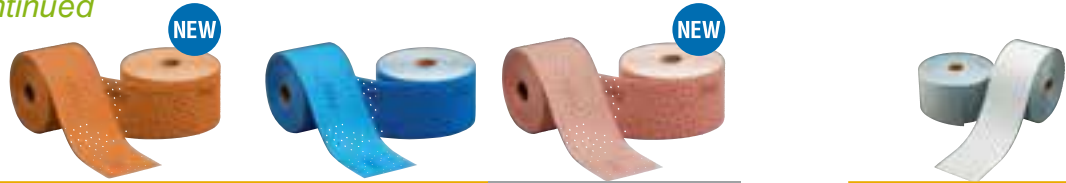

TIER:	BEST	BEST	BETTER	BEST	
TRADENAME:	<b>BLAZE A995 NO-FIL MULTI-AIR CYCLONIC</b>	<b>DRY ICE A975 NO-FIL MULTI-AIR CYCLONIC</b>	<b>A2750P NO-FIL MULTI-AIR CYCLONIC</b>	<b>DRY ICE A975 NO-FIL</b>	
ABRASIVE:	Ceramic Alumina	Ceramic Alumina	Aluminum Oxide	Ceramic Alumina	
BACKING WEIGHT:	D-Weight.	C- & B-Weight	D-Weight	B-Weight.	
BACKING ATTACHMENT:	Hook & Loop	Hook & Loop	Hook & Loop	Hook & Loop	
OTHER:	P-Graded	P-Graded	P-Graded	P-Graded	
SIZE:	2-3/4" x 13 yd	2-3/4" x 13 yd	2-3/4" x 13 yd	2-3/4" x 13 yd	
GRIT	PKG./CASE	PART #	PART #	PKG./CASE	PART #
80	1/4	699573 <b>08899</b>	636425 <b>06113</b>	1/4	636425 <b>06261</b>
120	1/4	699573 <b>08900</b>	636425 <b>06114</b>	1/4	636425 <b>06259</b>
150	1/4	699573 <b>08901</b>	636425 <b>06117</b>	1/4	636425 <b>06258</b>
180	1/4	699573 <b>08902</b>	636425 <b>06118</b>	1/4	636425 <b>06257</b>
220	1/4	699573 <b>08903</b>	636425 <b>06119</b>	1/4	636425 <b>06256</b>
240	1/4		636425 <b>06120</b>		
320	1/4		636425 <b>06121</b>	1/4	636425 <b>06255</b>
400	1/4		636425 <b>06122</b>	1/4	666233 <b>29518</b>
500	1/4		636425 <b>06123</b>	1/4	666233 <b>29547</b>
600	1/4		636425 <b>06124</b>	1/4	666233 <b>29548</b>

2-3/4" wide hook and loop paper rolls are perforated at 2-3/4" which allows use on all standard lengths of hand blocks and file boards. Additional grit sizes available, contact your Norton rep for more details.

PSA (Pressure Sensitive Adhesive) Paper Rolls



TIER:	BEST	BEST	BEST	BETTER	BETTER	BETTER	BETTER	GOOD
TRADENAME:	<b>DRY ICE A975 NO-FIL</b>	<b>DRY ICE A975 NO-FIL</b>	<b>DRY ICE A975 NO-FIL</b>	<b>A275 OP NO-FIL</b>	<b>A275 OP NO-FIL</b>	<b>A275 OP NO-FIL</b>	<b>A275 OP NO-FIL</b>	<b>GOLD RESERVE A296 NO-FIL</b>
ABRASIVE:	Ceramic Alumina	Ceramic Alumina	Ceramic Alumina	Aluminum Oxide	Aluminum Oxide	Aluminum Oxide	Aluminum Oxide	Aluminum Oxide
BACKING WEIGHT:	C-Weight.	C-Weight.	B-Weight.	B-Weight.	B-Weight.	B-Weight.	B-Weight.	B-Weight
BACKING ATTACHMENT:	PSA	PSA	PSA	PSA	PSA	PSA	PSA	PSA
OTHER:	P-Graded	P-Graded	P-Graded	P-Graded	P-Graded	P-Graded	P-Graded	P-Graded
SIZE:	2-3/4" x 25 yd	2-3/4" x 30 yd	2-3/4" x 45 yd	2-3/4" x 25 yd	2-3/4" x 30 yd	2-3/4" x 45 yd	4-1/2 x 10 yd	2-3/4" x 25 yd
GRIT	PKG./CASE	PART #	PART #	PART #	PART #	PART #	PART #	PART #
80	1/5	662611 <b>49566</b>			662611 <b>131691</b>		662611 <b>131697</b>	636425 <b>06153</b>
100	1/5					662611 <b>131690</b>	662611 <b>131696</b>	
120	1/5		662611 <b>49564</b>			662611 <b>131689</b>	662611 <b>131695</b>	636425 <b>06152</b>
150	1/5			662611 <b>49563</b>			662611 <b>131688</b>	662611 <b>131694</b>
180	1/5			662611 <b>49562</b>			662611 <b>131687</b>	662611 <b>131693</b>
220	1/5			662611 <b>49561</b>			662611 <b>131686</b>	662611 <b>131692</b>
240	1/5						662611 <b>131685</b>	
320	1/5			662611 <b>49558</b>			662611 <b>131683</b>	636425 <b>06148</b>
400	1/5			662611 <b>49557</b>			662611 <b>131681</b>	636425 <b>06147</b>
600	1/5						662611 <b>131679</b>	

Additional attachment options available as non-stock, contact your Norton rep for more details.

## Roll Accessories

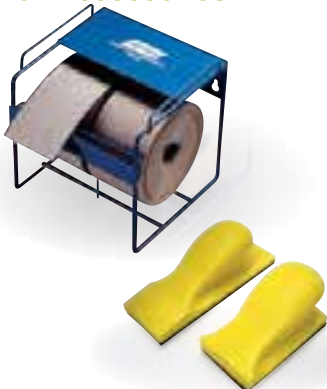

### PSA Roll Dispenser

- Heavy-duty wire dispenser has a vinyl coating to protect the work surface
- Accommodates two 2-3/4" PSA rolls; stackable for multi-grit operations. Attach to wall or mount on cabinet

DESCRIPTION	STD. PKG.	PART #
PSA Roll Dispenser	1	636425 <b>42773</b>

### PSA/Hook & Loop Sanding Blocks

- Ergonomically-shaped flexible foam blocks used with 2-3/4" rolls, fit comfortably in your hand
- Firm block produces a truly flat surface
- The soft block is designed for flat surfaces and contours

SIZE	DESCRIPTION	STD. PKG.	BACKING ATTACHMENT: PSA		Hook & Loop	
			PART #	PART #	PART #	PART #
2-3/4 x 5	Soft	5	636425 <b>42090</b>		636425 <b>42092</b>	
2-3/4 x 5	Firm	5	636425 <b>42091</b>		636425 <b>42093</b>	
2-3/4 x 7-3/4	Soft	5			636425 <b>42095</b>	
2-3/4 x 7-3/4	Firm	5	636425 <b>42094</b>			

Paper File Strips

Better choice for soft material applications

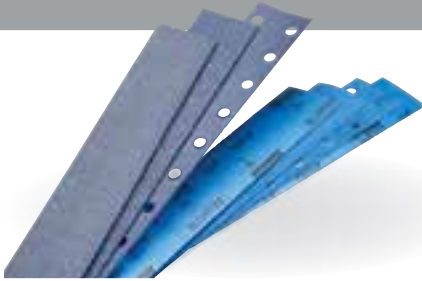

## BLUEFIRE H875P ZIRCONIA ALUMINA

- Strong zirconia alumina plus abrasive provides 2 - 3 times life over aluminum oxide products
- Strong E-weight paper, synthetically-coated for excellent durability and chip resistance plus superior bond system optimizes grain adhesion and extends product life
- Non-stearated (no anti-loading agents); non-contamination often required for prime auto and aerospace paint applications

Paper File Strips  
PSA (Pressure Sensitive Adhesive)  
and Non-PSA

TIER:	BEST				BETTER		BETTER		BETTER	
TRADENAME:	<b>A2750P NO-FIL</b>	<b>A2750P NO-FIL</b>	<b>A2750P NO-FIL</b>	<b>A2750P NO-FIL</b>	<b>BLUEFIRE H875P</b>	<b>BLUEFIRE H875P</b>	<b>BLUEFIRE H875P</b>	<b>BLUEFIRE H875P</b>	<b>BLUEFIRE H875P</b>	<b>BLUEFIRE H875P</b>
ABRASIVE:	A/O	A/O	A/O	A/O	Z/A	Z/A	Z/A	Z/A	Z/A	Z/A
BACKING WEIGHT:	B-Weight	B-Weight	B-Weight	B-Weight	E-Weight	E-Weight	E-Weight	E-Weight	E-Weight	E-Weight
BACKING ATTACHMENT:	Non-PSA	PSA	Hook/Loop	Hook/Loop Vac	Non-PSA	PSA	PSA	PSA	PSA	Hook/Loop
OTHER:	P-Graded	P-Graded	P-Graded	P-Graded						

SIZE (W x L)	GRIT	PKG./CASE	PART #	PART #	PART #	PART #	PKG./CASE	PART #	PART #	PKG./CASE	PART #	
2-3/4 x 16	100	50/500				662611	<b>131657</b>					
	120	50/500				662611	<b>131656</b>					
	180	50/500				662611	<b>131654</b>					
2-3/4 x 16-1/2	36						50/250		662611	<b>123610</b>	25/125 662611	<b>123616</b>
	40						50/250		662611	<b>123609</b>	25/125 662611	<b>123615</b>
	80	50/500		662611	<b>131640</b>	662611	<b>131646</b>	50/250	662611	<b>123608</b>	25/125 662611	<b>123614</b>
	100	50/500		662611	<b>131639</b>	662611	<b>131645</b>					
	120	50/500				662611	<b>131644</b>					
	150	50/500		662611	<b>131637</b>	662611	<b>131643</b>					
	180	50/500		662611	<b>131636</b>	662611	<b>131642</b>					
	220	50/500				662611	<b>131641</b>					
2-3/4 x 17-1/2	36						50/250	662611	<b>123622</b>			
	40						50/250	662611	<b>123621</b>			
	80	50/500	662611	<b>131652</b>			50/250	662611	<b>123620</b>			
	100	50/500	662611	<b>131651</b>			50/250	662611	<b>126512</b>			
	120	50/500	662611	<b>131650</b>								
	150	50/500	662611	<b>131649</b>								
	180	50/500	662611	<b>131648</b>			50/250	662611	<b>126511</b>			

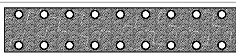

VACUUM HOLE PATTERN FOR  
2-3/4 X 16 FILE STRIPS

## Sanding Boards

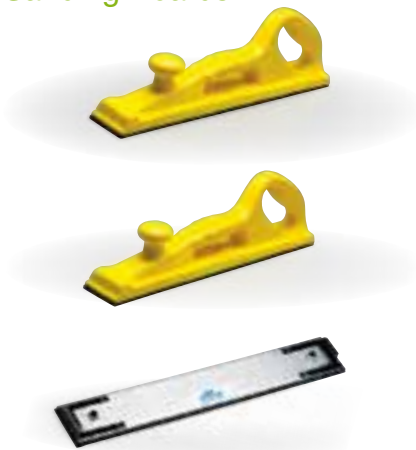

### PSA/Non-PSA Sanding Board

- This sanding board has a cushioned surface
- Spring clips mounted at each end securely hold 2-3/4" x 16-1/2" PSA file strips and 2-3/4" x 17-1/2" non-PSA file strips

### Hook and Loop and Non-PSA Sanding Board

- Lightweight, rugged design for easy sanding of plastic fillers
- Spring clips mounted at each end securely hold 2-3/4" x 16-1/2" hook and loop file strips and 2-3/4" x 17-1/2" non-PSA file strips
- Air file shoe eliminates the need for clips. The quick-change backing positively locks and unlocks for fast use.

DESCRIPTION	STD. PKG.	PART #
PSA/Non-PSA File Strip Sanding Board	6	636425 <b>42724</b>
Hook and Loop/Non-PSA File Strip Sanding Board	5	636425 <b>52836</b>
Hook and Loop Air File Shoe	5	636425 <b>52835</b>

## Stearated (Non-Loading) 9" x 11" Sheets

The best choice for sanding painted surfaces, composites, plastics or any material that tends to load



### A2750P NO-FIL ALUMINUM OXIDE

- Premium, P-graded, heat-treated aluminum oxide abrasive for consistent surface finish, exceptional performance on all surfaces and coatings
- Unique fiber-reinforced, B-weight latex-saturated backing for 50 - 60 percent improvement in tear strength, exceptional flexibility, can be folded without cracking
- Non-pigmented, water based stearate (anti-clog) coating, open coat for best resistance to clogging and loading during sanding

Best choice for moderate material removal

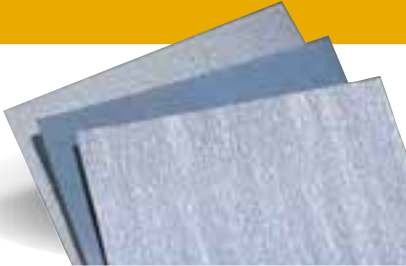

### A259PS NO-FIL ALUMINUM OXIDE

- Premium heat-treated abrasive offers faster cut and long sanding life
- Open coat, non-pigmented, water-based stearate coating prevents color transfer and minimizes loading
- Increased backing weight, fiber-reinforcement and latex saturation offers better grain retention and tear-resistance yet is highly flexible for easy folding and unfolding

The better choice for gel coats, hard composite substrates, abrasion-resistant coatings, and woodworking applications

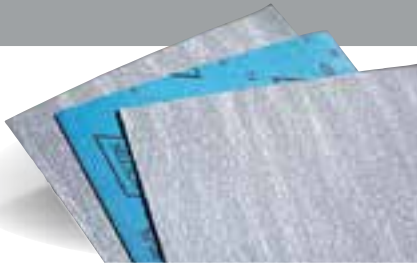

### DURITE A475 NO-FIL SILICON CARBIDE

- P-graded, silicon carbide abrasive for easy penetration of the hardest surfaces
- Water based stearate, non-pigmented, No-Fil coating resists loading for the longest usable product life; no color transfer to work
- Fiber-reinforced, latex paper backing provides flexibility and resistance to tearing

Good choice for fast cuts and an even finish



### PB273 NO-FIL ALUMINUM OXIDE

- P-graded, sharp light-brown, aluminum oxide abrasive for fast cut rate, extended life and consistent finish
- Water based non-pigmented stearate provides maximum load resistance and extended life; no dye in coating means no risk of color transfer or finish contamination
- Flexible latex-saturated B-weight backing, with a full resin bond and open coat for improved life

### Stearated (Non-Loading) 9" x 11" Sheets *continued*

9 x 11  
Paper Sheets



		<b>JOBPACK</b>				
		<b>BEST</b>	<b>BEST</b>	<b>BETTER</b>	<b>GOOD</b>	
TIER:		<b>A2750P</b>	<b>A259PS</b>	<b>DURITE A475</b>	<b>PB273</b>	
TRADENAME:		<b>NO-FIL</b>	<b>NO-FIL</b>	<b>NO-FIL</b>	<b>NO-FIL</b>	
ABRASIVE:		Aluminum Oxide	Aluminum Oxide	Silicon Carbide	Aluminum Oxide	
BACKING WEIGHT:		B-Weight	C- & B-Weight	B-Weight	B-Weight	
OTHER:		P-Graded	P-Graded	P-Graded	P-Graded	
SIZE (W x L)	GRIT	PKG./CASE	PART #	PART #	PART #	PART #
9 x 11	80	50/250	662611 <b>31634</b>	076607 <b>68174*</b>	662544 <b>87393</b>	666233 <b>11878</b>
	100	100/500	662611 <b>31633</b>	076607 <b>68173*</b>	662544 <b>87394</b>	666233 <b>11877</b>
	120	100/500	662611 <b>31632</b>	076607 <b>68172*</b>	662544 <b>87395</b>	666233 <b>11876</b>
	150	100/500	662611 <b>31631</b>	076607 <b>68171*</b>	662544 <b>87396</b>	666233 <b>11875</b>
	180	100/500	662611 <b>31630</b>	076607 <b>68168*</b>	662544 <b>87397</b>	666233 <b>11874</b>
	220	100/500	662611 <b>31629</b>	076607 <b>68167*</b>	662544 <b>87398</b>	666233 <b>11873</b>
	240	100/500	662611 <b>31628</b>		662544 <b>87399</b>	666233 <b>11879</b>
	280	100/500	662611 <b>31627</b>			
	320	100/500	662611 <b>31626</b>	076607 <b>68166*</b>	662544 <b>87400</b>	666233 <b>11871</b>
	400	100/500	662611 <b>31624</b>	076607 <b>68165*</b>		666233 <b>11870</b>
	500	100/500	662611 <b>31623</b>			
	600	100/500	662611 <b>31622</b>			
	800	100/500	662611 <b>31621</b>			
	1000	100/500	662611 <b>31620</b>			
	1200	100/500	662611 <b>31619</b>			
	1500	100/500	662611 <b>31618</b>			

\* Packaging Standards: A259PS Job Packs: 20 sheets per pack / 10 packs per standard package for a total of 200 sheets

### Rubber Hand Sanding Blocks

- Resilient rubber blocks that conform well to mild contours and flat surfaces

DESCRIPTION	STD. PKG.	PART #
2-3/4 x 5	5	076607 <b>01889</b>



## Waterproof 9" x 11" Sheets

Best choice for superior cut and life in wet applications

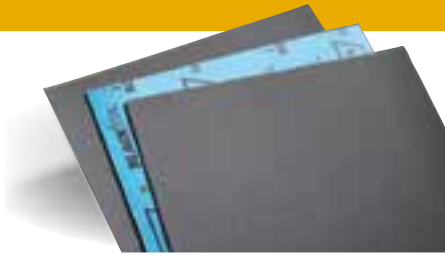

### BLACK ICE T214 ALUMINUM OXIDE WATERPROOF

- Premium, P-graded, heat-treated aluminum oxide abrasive for ultimate cut and life in wet applications
- Strong resin bond for longer life in wet applications
- High-strength B-weight waterproof latex paper backing is extremely flexible, environmentally stable, and resists humidity-caused curling

Best choice for superior finish in wet applications

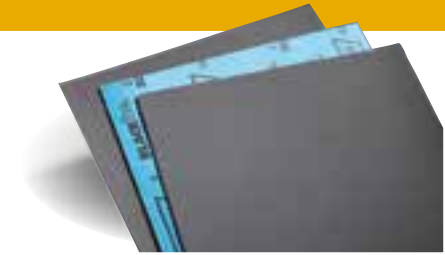

### BLACK ICE T401 SILICON CARBIDE WATERPROOF

- Premium, JIS graded ultra-fine silicon carbide abrasive provides the ultimate finish in wet applications
- Strong resin bond for longer life in wet applications
- High-strength B-weight waterproof latex paper backing is extremely flexible, environmentally stable, and resists humidity-caused curling

Better choice for wet finishing applications

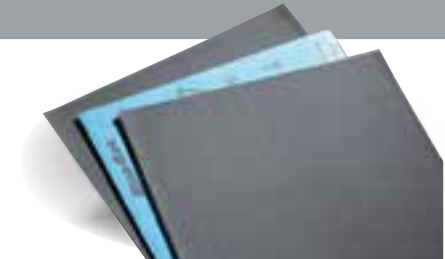

### BLUE-BAK T414 SILICON CARBIDE

- Sharp, ANSI graded silicon carbide abrasive for exceptional finishes in wet applications
- Strong resin bond for longer life in wet applications
- High-strength B-weight waterproof latex paper backing is extremely flexible, environmentally stable, and resists humidity-caused curling

Good choice for medium material removal in wet applications



### TUFBAK T461 SILICON CARBIDE

- ANSI graded silicon carbide abrasive for fast cutting with excellent finish in wet applications
- Advanced resin bond system for excellent flexibility and abrasive adhesion
- Strong, waterproof C-weight backing is ideal for more aggressive applications while being environmentally stable, resists product curl in humidity

Waterproof 9" x 11" Sheets *continued*

9 x 11  
Paper Sheets



		TIER: BEST	BEST	BETTER	GOOD
		TRADENAME: BLACK ICE T214	BLACK ICE T401	BLUE-BAK T414	TUFBAK T461
		ABRASIVE: Aluminum Oxide	Silicon Carbide	Silicon Carbide	Silicon Carbide
		BACKING WEIGHT: B-Weight	B-Weight	B-Weight	C-Weight
		OTHER: P-Graded	JIS Graded	ANSI Graded	ANSI Graded
SIZE (W x L)	GRIT	PKG./CASE	PART #	PART #	PART #
9 x 11	60	50/250			662611 <b>01175</b>
	80	50/250			662611 <b>01170</b>
	100	50/250			662611 <b>01165</b>
	120	50/250			662611 <b>01160</b>
	150	50/250			662611 <b>01155</b>
	180	50/250			662611 <b>01150</b>
	220	50/250	662611 <b>39389</b>		662611 <b>39367</b>
	240	50/250	662611 <b>39388</b>		662611 <b>39366</b>
	280	50/250			662611 <b>39365</b>
	320	50/250	662611 <b>39386</b>		662611 <b>39364</b>
	360	50/250			662611 <b>39363</b>
	400	50/250	662611 <b>39385</b>		662611 <b>39362</b>
	500	50/250	662611 <b>39384</b>		662611 <b>39361</b>
	600	50/250	662611 <b>39383</b>		662611 <b>39360</b>
	800	50/250	662611 <b>39382</b>		662611 <b>30334</b>
	1000	50/250		662611 <b>39381</b>	
	1200	50/250		662611 <b>39380</b>	
	1500	50/250		662611 <b>39379</b>	
	2000	50/250		662611 <b>39378</b>	
	2500	50/250		662611 <b>39377</b>	

Waterproof Sanding Blocks – with “Grabbing” Power



Dual Density Wet Sanding Block

- No adhesive required: simply wrap a 5-1/2" x 9" (9" x 11" cut in half) sheet around the block
- The dense side is for more aggressive blocking, while the soft side is for color sanding
- Equalizes sanding pressure for fine grit applications

Holey Block

- No adhesive required: simply wrap a 5-1/2" x 9" (9" x 11" cut in half) sheet around the block
- A rugged, semi-rigid, multi-purpose sanding block engineered for flat to medium curved surfaces
- A tactical hole pattern side provides numerous cutting edges to create a 30% faster cut rate
- The plain side provides firmness and a comfortable, easy-to-hold surface

DESCRIPTION	STD. PKG.	PART #
Wet Sanding Block	12	636425 <b>03728</b>
Holey Block	8	636425 <b>03729</b>

All-Purpose 9" x 11" Paper Sheets

Good choice for your wood, metal or composite sanding projects



A211/A212/A213 ALUMINUM OXIDE

- P-graded, aluminum oxide grain, open-coat provides aggressive, long-lasting cutting action
- Use for dry, general purpose hand sanding on hardwood, metal, and composites
- Available in multiple backing weights: A212 A-weight; A213 C-weight, A211 D-weight

Good choice for use on soft woods such as pine



A513/A511 GARNET

- Natural garnet abrasive is ideal for soft woods, such as pine, and produces an excellent, consistent finish
- Use dry on bare wood prior to coating
- Available in two backing weights: A511 A-wt. and A513 C-wt. for heavy-duty to light-duty hand sanding

9 x 11  
Paper Sheets



TIER:	GOOD	GOOD	GOOD	GOOD	GOOD	GOOD	GOOD
TRADENAME:	<b>A211</b>	<b>A213</b>	<b>A212</b>	<b>JOBPACK</b> MULTISAND A213/A212	<b>A513</b>	<b>A511</b>	<b>JOBPACK</b> WOODSAND A513/A511
ABRASIVE:	Aluminum Oxide	Aluminum Oxide	Aluminum Oxide	Aluminum Oxide	Garnet	Garnet	Garnet
BACKING WEIGHT:	D-Weight	C-Weight	A-Weight	D-, C- & A-Weight	D- & C-Weight	A-Weight	D-, C- & A-Weight
OTHER:	P-Graded	P-Graded	P-Graded	P-Graded			

SIZE (W x L)	GRIT	PKG./CASE	PART #	PART #	PART #	PART #	PART #	PART #	PART #
9 x 11	36	25/125	662611 <b>00335</b>						
	40	25/125	662611 <b>00330</b>						
	50	50/250	662611 <b>00325</b>						
	60	50/250		662611 <b>00320</b>			662611 <b>01560</b>		
	80	50/250		662611 <b>00315</b>			662611 <b>01555</b>	662611 <b>01505</b>	076607 <b>01584*</b>
	100	100/500		662611 <b>00295</b>		076607 <b>00358*</b>	662611 <b>01535</b>	662611 <b>01500</b>	076607 <b>01583*</b>
	120	100/500		662611 <b>00290</b>		076607 <b>00357*</b>	662611 <b>01530</b>	662611 <b>01495</b>	076607 <b>01582*</b>
	150	100/500		662611 <b>00285</b>		076607 <b>00356*</b>	662611 <b>01525</b>	662611 <b>01490</b>	076607 <b>01581*</b>
	180	100/500			662611 <b>00245</b>	076607 <b>00355*</b>		662611 <b>01489</b>	076607 <b>01580*</b>
	220	100/500			076607 <b>00156</b>	076607 <b>00354*</b>		662611 <b>01488</b>	076607 <b>01579*</b>
	Asst+	100/500				076607 <b>00365*</b>			

\* Packaging Standards: Job Packs: 25 sheets per pack / 10 packs per standard package for a total of 250 sheets  
+ Assorted contains 6 each of 60, 100, 150 grit and 7 each of 220 grit

3-2/3 x 9  
Paper Cut Sheets



TIER:	GOOD	GOOD
TRADENAME:	<b>A290 NO-FIL</b>	<b>A213</b>
ABRASIVE:	Aluminum Oxide	Aluminum Oxide
BACKING WEIGHT:	C-Weight	C-Weight
OTHER:	P-Graded	P-Graded

SIZE (W x L)	GRIT	PKG./CASE	PART #	PART #
3-2/3 x 9	60	100/1000		662611 <b>02925</b>
	80	100/1000	662611 <b>01119</b>	662611 <b>02920</b>
	100	100/1000		662611 <b>02900</b>
	180	100/1000	662611 <b>01124</b>	
	220	100/1000	662611 <b>01123</b>	





Surface finishing rolls are made of a non-woven nylon web impregnated with abrasive grain and resin bond.

**Applications:**

Light- to heavy-duty cleaning, deburring, blending, polishing, and finishing of metal, wood, composite, plastics, stone, solid surface and painted surfaces.

**Abrasive Grain:**

Aluminum Oxide, Silicon Carbide

**Grit Range:**

Medium (M), Fine (F), Very Fine (VF), Ultra Fine (UF), Micro Fine (MF)

**Roll Features:**

- Economical alternative to cut pads
- Can be cut to specific sizes

**Machine Used:**

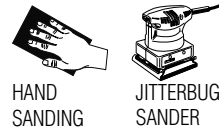

HAND  
SANDING

JITTERBUG  
SANDER

### Application/Grit Recommendation Guide

MORE AGGRESSIVE, ROUGHER FINISH

LESS AGGRESSIVE, FINER FINISH



	#740	#644	#747	#635	#851	#777	HIGH STRENGTH
<b>PRODUCT #:</b>	#740	#644	#747	#635	#851	#777	HIGH STRENGTH
<b>COLOR:</b>	Dark Tan	Maroon	Maroon	Gray	Gray	Maroon	Maroon
<b>DESCRIPTION:</b>	Heavy Duty	GP – Fine	GP Plus – Very Fine	Clean & Finish	General Cleaning	General Purpose	High Strength
<b>ABRASIVE:</b>	AO	AO	AO	SC	SC	AO	AO
<b>GRIT SIZE:</b>	Medium 100 - 150	Fine 180 - 220	Very Fine 240 - 360	Ultra Fine 400 - 600	Very Fine 240 - 360	Very Fine 240 - 360	Medium 100 - 150
<b>STEEL WOOL EQUIVALENT:</b>	4 Extra Coarse	2 Medium Coarse	1 Medium	00 Very Fine	00 Very Fine	1 Medium	4 Extra Coarse
<b>APPLICATIONS:</b>	<ul style="list-style-type: none"> <li>• Smear-free Clean Bond technology</li> <li>• 2X life</li> <li>• Most durable and aggressive cutting pad</li> <li>• Heavy-duty removal                             <ul style="list-style-type: none"> <li>» rust</li> <li>» oxidation</li> </ul> </li> <li>• Deburring</li> </ul>	<ul style="list-style-type: none"> <li>• Cleaning and deburring                             <ul style="list-style-type: none"> <li>» machinery</li> <li>» metal parts</li> <li>» plastic</li> <li>» solid surface</li> <li>» stone</li> </ul> </li> </ul>	<ul style="list-style-type: none"> <li>• Light cleaning, deburring and finishing                             <ul style="list-style-type: none"> <li>» machinery</li> <li>» metal parts</li> <li>» plastic</li> <li>» solid surface</li> <li>» stone</li> </ul> </li> </ul>	<ul style="list-style-type: none"> <li>• Light cleaning and finishing of most surfaces                             <ul style="list-style-type: none"> <li>» steel, aluminum</li> <li>» denibbing plastic</li> <li>» scuffing acrylics</li> </ul> </li> </ul>	<ul style="list-style-type: none"> <li>• Light cleaning and finishing of most surfaces                             <ul style="list-style-type: none"> <li>» steel, aluminum</li> <li>» denibbing plastic</li> <li>» scuffing acrylics</li> </ul> </li> </ul>	<ul style="list-style-type: none"> <li>• Light cleaning, deburring and finishing                             <ul style="list-style-type: none"> <li>» machinery</li> <li>» metal parts</li> <li>» plastic</li> <li>» solid surface</li> <li>» stone</li> </ul> </li> </ul>	<ul style="list-style-type: none"> <li>• Moderate deburring and surface blending</li> </ul>

SIZE (W x L)	COLOR	DESCRIPTION	ABRASIVE	GRIT SIZE	STD. PKG.	TIER: BEST BETTER	
						PART #	PART #
<b>Non-Woven Rolls</b>							
4" x 30 Ft.	Maroon	High Strength Roll	A/O	M	3	662610 <b>06358</b>	
	Dark Tan	740 Heavy-Duty Roll	A/O	M	3		662610 <b>10081</b>
	Maroon	644 General Purpose Fine Roll	A/O	F	4		662610 <b>58364</b>
	Maroon	777 General Purpose Very Fine Roll	A/O	VF	4	662610 <b>06373</b>	662610 <b>58361</b>
	Maroon	747 General Purpose Plus Roll	A/O	VF	4		662610 <b>51701</b>
	Gray	851 General Cleaning Roll	S/C	VF	4		662610 <b>58360</b>
	Gray	635 Clean & Finish Roll	S/C	UF	5		662610 <b>58357</b>
6" x 30 Ft.	Maroon	High Strength Roll	A/O	M	2	662610 <b>05182</b>	
	Maroon	747 General Purpose Plus Roll	A/O	VF	3		662610 <b>16430</b>
	Maroon	777 General Purpose Very Fine Roll	A/O	VF	3	662610 <b>04281</b>	662610 <b>58376</b>
	Gray	851 General Cleaning Roll	S/C	VF	3		662610 <b>58377</b>
2" x 15 Ft. Handy Roll Pack	Assorted	1 each A/O Fine, A/O VF, SC MF	–	–	1		662610 <b>08108</b>



Flexible, abrasive sanding sponges for a wide variety of curved, contoured or flat surface applications on wood, metal, paint, plastic, ceramics and drywall.

**Applications:**

Light stock removal, sanding sealer and wash-coats, touch-up or repair of primer, sanding contours and intricate shapes, and finishing

**Benefits:**

- Can be used wet or dry
- Clog resistant, washable, reusable
- Easy to use, can be folded without cracking
- Conformable
- Generate a consistent surface finish

**Machine Used:**



HAND  
SANDING

**Why Choose Abrasive Sponges Versus Conventional Sheets?**

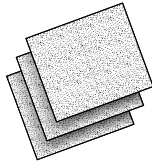
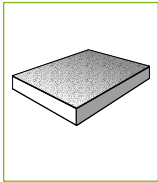

**Eliminate Clogging**

- The combination of flexible foam backing material and abrasive grit adhesion continually releases sanded material
- Any clogging can be washed out

**Pressure Control**

- Foam backing allows optimum pressure distribution to prevent sanding through surfaces
- Pressure spots are eliminated providing even surface pattern

**Adapt to Contours**

- Flexible foam allows adaptability to contours, shapes or areas of limited access
- No folding or buckling results in an even pattern without scratching

**Surface Finishing Chart – Contour Sponges versus Sheets**

	← COARSER													FINER →
<b>SHEETS</b>	P150	P180	P220	P280	P320	P400	P500	P600	P800	P1000	P1200	P1500	P2000	
	Medium 60		Fine 100		Extra Fine 150			Super Fine 180		Ultra Fine 220		Micro Fine 280/320		
	<b>SPONGES</b>													

**Surface Finishing Chart – Sponges versus Sheets**

	← COARSER													FINER →	
<b>SHEETS</b>	P80	P100	P120	P150	P180	P220	P280	P320	P400	P500	P600	P800	P1000	P1200	
	Extra Coarse 36		Coarse 60		Medium 80 - 120			Fine 120 - 150		Very Fine 180 - 220				Micro Fine 280 - 320	
	<b>SPONGES</b>														

**Cross Reference Guide**

	BETTER	GOOD	GOOD	GOOD	GOOD	GOOD
<b>NORTON</b>	SoftTouch	Contour	Small Area	Profile	Sealer Sanding	Flexible
3M	Softback	Contour	Full Size	High Flexibility	Woodworking	Pro Pads
Hermes	Single Side	–	Four Sided	–	Two Sided	–
Klingspor	–	–	–	–	Foam Sanding Pad	–
SIA	Flat Pad	–	Standard Block	–	Standard Pad	–

For hand-sanding or finishing flat, curved, contoured and hard-to-reach areas on wood, metal, composites, paint and solid surfaces

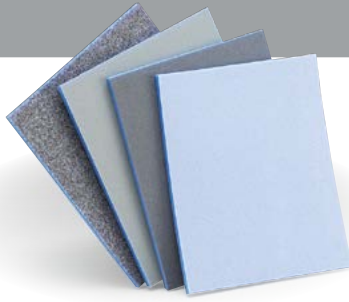

### SOFTTOUCH CONTOUR SPONGES – COATED 1 SIDE

- Superior flexibility
- Premium foam substrate provides for an extremely smooth and uniform sanded surface

SIZE (W x L x T)	GRIT	STD. PKG.	PART #
4-1/2 x 5-1/2 x 3/16	60 Medium	80	076607 <b>03074</b>
	100 Fine	80	076607 <b>03075</b>
	180 Super Fine	80	076607 <b>03076</b>
	220 Ultra Fine	80	076607 <b>03077</b>
	280 Micro Fine	80	076607 <b>03078</b>

Good for sanding small diameters and contours



### CONTOUR SPONGES – COATED 1 SIDE

- Thin, flexible; good for sanding small diameters and contours such as ceramics, spindles, turnings and railings

SIZE (W x L x T)	GRIT	STD. PKG.	PART #
4-1/2 x 5-1/2 x 3/16	100 Fine	100	076607 <b>02257</b>
	150 Extra Fine	100	076607 <b>02256</b>
	220 Ultra Fine	100	076607 <b>02255</b>

Good for a wide variety of materials and sanding applications where moderate flexibility is needed

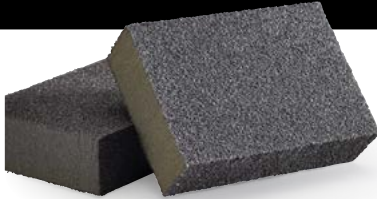

### SMALL AREA GENERAL PURPOSE SPONGES – COATED 4 SIDES

- Medium to firm density open cell polyurethane foam provides uniform support and moderately aggressive cutting action while generating a smooth surface

SIZE (W x L x T)	GRIT	STD. PKG.	PART #	BULK PKG.	PART #
4 x 2-3/4 x 1	36/80	24	076607 <b>49505</b>	250	076607 <b>04735</b>
	Ex. Coarse/Med				
	80/80	24	076607 <b>49507</b>	250	076607 <b>01875</b>
	Med/Med				
	80/120	24	076607 <b>49504</b>	250	076607 <b>02600</b>
	Med/Fine				
	120/120	24	076607 <b>49506</b>		
	Fine/Fine				

Good for corners and flat surfaces on wood, metal, plastic and paint



### PROFILE SPONGES – COATED 3 SIDES

- Ideal for cabinet sanding of raised profile doors

SIZE (W x L x T)	GRIT	STD. PKG.	PART #
4 x 2-3/4 x 1/2	100 Medium	500	636425 <b>6313</b>

Good for sanding primers, sealers and between coats on furniture and cabinets

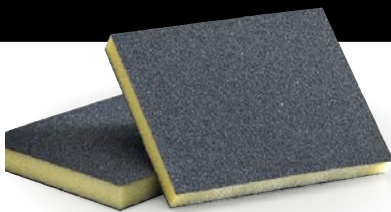

### SEALER SANDING SPONGES – COATED 2 SIDES

- Very flexible; silicon carbide abrasive for sanding primers, sealers and between coats on furniture and cabinets

SIZE (W x L x T)	GRIT	BULK PKG.	PART #
4-3/4 x 3-3/4 x 1/2	36 Extra Coarse	250	636425 <b>02538</b>
	60 Coarse	250	636425 <b>52870</b>
	100 Medium	250	636425 <b>52869</b>
	220 VeryFine	250	636425 <b>52868</b>

Ideal for final sanding of surfaces, primer sanding, and between coats sanding



### FLEXIBLE ABRASIVE SPONGES – COATED 1 SIDE

- Best initial price point for abrasive sponges

SIZE (W x L x T)	GRIT	STD. PKG.	PART #	BULK PKG.	PART #
3 x 4 x 1/2	60 Coarse	48	076607 <b>04068</b>	108	076607 <b>01110</b>
	80 Medium	48	076607 <b>04067</b>	108	076607 <b>04070</b>
	100 Medium	48	076607 <b>04066</b>	108	076607 <b>00950</b>
	150 Fine	48	076607 <b>04065</b>	108	076607 <b>00949</b>
	220 Very Fine			108	076607 <b>04069</b>

# Non-Woven Hand Pads and Sponges



Surface finishing hand pads are made of a non-woven nylon web impregnated with abrasive grain and resin bond.

**Applications:**

Light- to heavy-duty cleaning, deburring, blending, polishing, and finishing of metal, wood, composite, plastics, stone, solid surface and painted surfaces.

**Abrasive Grain:**

Aluminum Oxide, Silicon Carbide

**Grit Range:**

Medium (M), Fine (F), Very Fine (VF), Ultra Fine (UF), Micro Fine (MF), Non-Abrasive (-)

**Hand Pad Features:**

- Flexible; conform to work surface
- Gentle action easily removes flashing or burrs without affecting dimension of workpiece
- Non-loading; constant supply of new cutting edges
- Non-rusting; no workpiece contamination
- Resilient construction; long life, increased productivity; solvent resistant; waterproof

**Sponge Pad Features:**

- Non-woven material is laminated to a long-lasting sponge for the convenience of 2 pads in one
- Superior replacement for steel wool

**Machine Used:**



HAND SANDING



JITTERBUG SANDER

## Application/Grit Recommendation Guide

MORE AGGRESSIVE, ROUGHER FINISH

LESS AGGRESSIVE, FINER FINISH



PRODUCT #:	#740	#746	#644	#747	#796	#635	#748	THIN-FLEX VF	THIN-FLEX UF	THIN-FLEX BP	#456
COLOR:	Dark Tan	Gray	Maroon	Maroon	Green	Gray	Gray	Maroon	Gray	Gold	White
DESCRIPTION:	Heavy Duty	Blending	GP - Fine	GP Plus - Very Fine	Scouring	Clean & Finish	Final Shine	Cleaning	Cleaning	Blend Prep	Cleaning
ABRASIVE:	AO	SC	AO	AO	AO	SC	SC	AO	SC	AO	Non-Abrasive
GRIT SIZE:	Medium 100 - 150	Medium 100 - 150	Fine 180 - 220	Very Fine 240 - 360	Very Fine 240 - 360	Ultra Fine 400 - 600	Micro Fine 800 - 1200	Very Fine 240 - 360	Ultra Fine 400 - 600	Micro-Fine 800 - 1200	Non-Abrasive ----
STEEL WOOL EQUIVALENT:	4 Extra Coarse	3 Coarse	2 Medium Coarse	1 Medium	0 Fine	00 Very Fine	00 Very Fine	00 Very Fine	000 Extra Fine	000 Extra Fine	0000 Super Fine
APPLICATIONS:	<ul style="list-style-type: none"> <li>• Smear-free Clean Bond technology</li> <li>• 2X life</li> <li>• Most durable and aggressive cutting pad</li> <li>• Heavy-duty removal                             <ul style="list-style-type: none"> <li>» rust</li> <li>» oxidation</li> </ul> </li> <li>• Deburring</li> </ul>	<ul style="list-style-type: none"> <li>• Blending and deburring                             <ul style="list-style-type: none"> <li>» welds</li> <li>» aluminum</li> <li>» stainless</li> </ul> </li> </ul>	<ul style="list-style-type: none"> <li>• Cleaning and deburring                             <ul style="list-style-type: none"> <li>» machinery</li> <li>» metal parts</li> <li>» plastic</li> <li>» solid surface</li> <li>» stone</li> </ul> </li> </ul>	<ul style="list-style-type: none"> <li>• Light cleaning, deburring and finishing                             <ul style="list-style-type: none"> <li>» machinery</li> <li>» metal parts</li> <li>» plastic</li> <li>» solid surface</li> <li>» stone</li> </ul> </li> </ul>	<ul style="list-style-type: none"> <li>• Removing stains, marks, rust, corrosion or oxidation from stainless equipment</li> <li>• Light cleaning of metal surfaces</li> </ul>	<ul style="list-style-type: none"> <li>• Light cleaning and finishing of most surfaces                             <ul style="list-style-type: none"> <li>» steel, aluminum</li> <li>» denibbing plastic</li> <li>» scuffing acrylics</li> </ul> </li> </ul>	<ul style="list-style-type: none"> <li>• Final finishing                             <ul style="list-style-type: none"> <li>» final rub on wood</li> <li>» final blend on metal</li> <li>» final finish on plastics and acrylics</li> </ul> </li> </ul>	<ul style="list-style-type: none"> <li>• Maximum flexibility for consistent finishes</li> <li>• Cleaning, blending, finishing, and deburring in woodwork, metalwork, MRO, and synthetic applications</li> </ul>	<ul style="list-style-type: none"> <li>• Maximum flexibility for consistent finishes</li> <li>• Cleaning, blending, finishing, and deburring in woodwork, metalwork, MRO, and synthetic applications</li> </ul>	<ul style="list-style-type: none"> <li>• Fine cleaning                             <ul style="list-style-type: none"> <li>» metal</li> <li>» fiberglass</li> <li>» stone</li> <li>» solid surface</li> <li>» ceramic</li> <li>• Wood                                     <ul style="list-style-type: none"> <li>» high-lighting</li> <li>» rubbing</li> </ul> </li> </ul> </li> <li>• Top coat finishing (water-based and solvent)</li> </ul>	<ul style="list-style-type: none"> <li>• Scratch-free cleaning                             <ul style="list-style-type: none"> <li>» metal</li> <li>» fiberglass</li> <li>» stone</li> <li>» solid surface</li> <li>» ceramic</li> <li>• Wood                                     <ul style="list-style-type: none"> <li>» high-lighting</li> <li>» rubbing</li> </ul> </li> </ul> </li> </ul>

## Cross Reference Guide

COARSER

FINER

NORTON	#740	#746	#644	#747/847	#796	#635	#748	Thin-Flex VF	Thin Flex UF	#456
3M	7440	7446	64659	7447/8447 Production Hand Pad	96	64660	7448	Multi-Flex Maroon	Multi-Flex Gray	7445
Camel	Tan	—	—	Maroon	Green	—	Gray	—	—	White
Mirka	—	—	—	Maroon/Red VF	—	—	—	Mirlon Total Maroon	Mirlon Total Gray	—
Sait	Brown	—	—	Maroon	Green	—	Gray	—	—	—
SIA	6912 Brown	6712 Grey	—	6912 Maroon	6312 Green	—	—	—	—	—
Standard	HD-Tan AO	—	—	GP-Maroon VF	Green-AO	HP-VF	UF Gray	—	—	Cleaning White

SIZE (W x L)	COLOR	DESCRIPTION	ABRASIVE	GRIT SIZE	STD. PKG.	TIER: <b>BEST</b>	BETTER
						PART #	PART #
<b>Hand Pads</b>							
4-1/2 x 9	Maroon	Thin Flex Cleaning Pad	A/O	VF	25	666233 <b>98062</b>	
	Grey	Thin Flex Cleaning Pad	S/C	UF	25	666233 <b>98063</b>	
	Gold	Thin Flex Blend Prep	A/O	MF	25	662611 <b>13519</b>	
6 x 9	Dark Tan	740 Heavy-Duty Pad	A/O	Med	40	662610 <b>74000</b>	
	Gray	746 Blending Pad	S/C	Med	40		662610 <b>74600</b>
	Maroon	777 General Purpose Very Fine Pad	A/O	VF	60		662610 <b>77700</b>
	Maroon	747 General Purpose Plus Pad	A/O	VF	60	662610 <b>74700</b>	
	Maroon	847 General Purpose Plus Perforated Pad	A/O	VF	60	662610 <b>84700</b>	
	Green	796 Scouring Pad	A/O	VF	60		662610 <b>79600</b>
	Lt. Green	696 Food Pro Pad	A/O	VF	60		662610 <b>69600</b>
	Gray	851 General Cleaning Pad	S/C	VF	40		662610 <b>85100</b>
	Gray	635 Clean & Finish Pad	S/C	UF	60		662610 <b>63500</b>
	Gray	748 Final Shine Pad	S/C	MF	60		662610 <b>74800</b>
	White	456 Cleaning Pad	None	–	60		662610 <b>45600</b>
	<b>Hand Pad Holder</b>						
3-1/4 x 5-1/2	N/A	Hand Pad Holder			10		662610 <b>47583</b>
<b>Scouring Pads/Sponges</b>							
3-1/4 x 6-1/4 x 3/4	Green/Yellow	893 Scour-N-Sponge Pad	A/O	VF	40		662610 <b>59403</b>
3-1/4 x 6-1/4 x 3/4	White/Yellow	875 Clean-N-Sponge Pad	None	–	40		662610 <b>59402</b>



### THIN and FLEXIBLE: Perfect for Tight Spots

Norton Bear-Tex Thin-Flex High-Performance Hand Pads

- Achieve performance benefits of a coarse and fine grain product in one hand pad; fast cut and definitively better finish than competing pads
- Extremely thin and conformable; ideal for deburring, cleaning, blending, and finishing contoured surfaces and tight spaces
- Special coated web design for superior and constant cutting action without added effort from user
- Versatile; ideal for woodworking, metalworking, maintenance operations, and synthetics fabrication

## Rotolo Foam Sanding Pads

### Application/Grit Recommendation Guide

← COARSER												FINER →														
120	150	180	220	240	280	320	400	500	600	800	1000	120	150	180	220	240	280	320	400	500	600	800	1000			
Cleaning/Repairing			Final Sanding			Feather Edging			Basecoat Sanding			Clearcoat Sanding														

The better choice for fine sanding flat and curved surfaces

## A2750P NO-FIL ROTOLO FOAM ROLLS

- Premium, P-graded, heat-treated aluminum oxide abrasive for consistent surface finish, exceptional performance on all surfaces and coatings
- Foam backing is perfect for hand sanding primer without leaving finger marks; 50% – 60% improvement in tear strength versus conventional paper rolls; perforated for easy sizing
- Non-pigmented, water-based stearate No-Fil coating, open coat for best resistance to clogging and loading during sanding



TIER: **BETTER**  
 TRADENAME: **A275 OP ROTOLO**  
 ABRASIVE: Aluminum Oxide  
 OTHER: P-Graded

SIZE (W x L)	GRIT SIZE	ROLLS/STD. PKG.	PART #
4-1/2" x 82'	120	2	780727 <b>35316</b>
	150	2	780727 <b>57584</b>
	180	2	780727 <b>57599</b>
	220	2	780727 <b>57600</b>
	240	2	780727 <b>57602</b>
	320	2	666233 <b>57606</b>
	400	2	666233 <b>57608</b>
	500	2	666233 <b>57611</b>
	600	2	666233 <b>57612</b>
	800	2	666233 <b>57613</b>
	1000	2	666233 <b>57616</b>



# Flexible Diamond-Coated Hand Pads

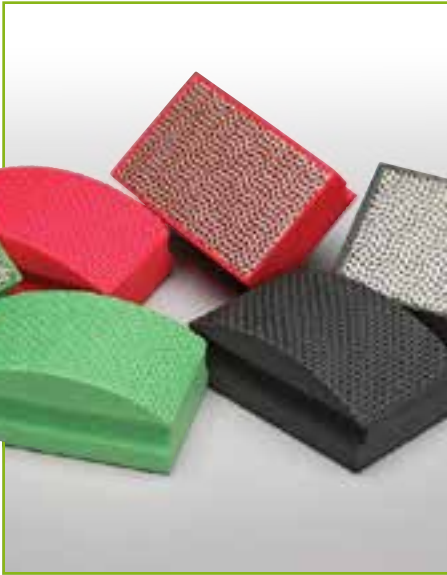

Norton flexible diamond coated hand pads combine the durability and aggressiveness of diamond, with a flexible backing.

**Applications:**

Diamond coated hand pads: shaping, rapid stock removal, touch-up and repair on ceramics, stone, marble, glass, composites and hard materials; polishing of dies and molds  
 Quadroflex diamond hand pads: surface conditioning, repairs, and removing flash and burrs on aircraft composites and windmill blades

**Size Range:**

3-1/2" x 2-1/8"

**Grit Range:**

60 – 1500

**Abrasive Types:**

Diamond

**Machine Used:**



HAND  
SANDING

Better choice for shaping, rapid stock removal, surface conditioning, touch-up, repair, and polishing



## FLEXIBLE DIAMOND-COATED HAND PADS – CONVENTIONAL AND QUADROFLEX CURVED

- Durable yet lightweight conformable backing is adaptable to a variety of shapes and conditions with long lasting performance; offers a uniform finish for improved surface quality
- Can be used wet or dry; color-coded by grit size for easy identification
- Conventional hand pads with precision dot pattern for an aggressive, consistent, fast cut rate and reduced dust and loading; Quadroflex curved hand pads offer ergonomic advantages and longest life for lowest overall total cost



			TIER BETTER		TIER BETTER	
			DIAMOND COATED HAND PADS		QUADROFLEX CURVED DIAMOND COATED HAND PADS	
			ABRASIVE: Diamond		ABRASIVE: Diamond	
SIZE (L x W)	COLOR	GRIT	STD. PKG.	PART #	PART #	
3-1/2 x 2-1/8	Green	60	1	662603 <b>06360</b>	690141 <b>21517</b>	
	Black	120	1	662603 <b>06361</b>	690141 <b>21518</b>	
	Red	200	1	662603 <b>06362</b>	690141 <b>23529</b>	
	Yellow	400	1	662603 <b>05852</b>	690141 <b>23530</b>	
	White	800	1	662603 <b>06363</b>	690141 <b>23531</b>	
	Blue	1500	1	662603 <b>06364</b>		
	Kit (one each of above)			1	662603 <b>07720</b>	

power...  
**IN THE PALM OF  
YOUR HAND**

New Portable Tools and the specialty abrasive products to go along with them. Access hard-to-reach areas with ease with the Norton Merit line of specialty products.







Put the world right in the palm of your hand with our 2" and 3" Norton Mini Angle Sanders. Small, compact enough to get into those hard-to-reach areas, and powerful enough to finish the job fast and efficiently.

**Specifications for:**

**Weight of tool:**

**Compressed air:**

**Maximum permissible operating pressure:**

**Horsepower:**

**Free speed:**

**Air consumption @90psi:**

**Noise characteristic value in accordance with EN ISO 15744 (ISO 15744):**

- A-weighted sound pressure level at workstation
- A-weighted sound power level
- Peak C-weighted instantaneous sound pressure level at workstation

**Measurement uncertainty (Standard):**

**Vibration value according to EN ISO 28927-3:**

**Recommended lubrications:**

**Sanding tool specifications:**

**Applications and suitability:**

**2" Mini Angle Air Sander    3" Mini Angle Air Sander**

1.6 lbs. (0.742kg)

6.2 bar (90psi)

6.2 bar (90psi)

.45

22,000 rpm

85 liters/min (3 CFM)

87.3 dB

98.3 dB

<130 dB

3.00 m/s<sup>2</sup>

0.84 m/s<sup>2</sup>

Air oil 20#

Pad Size 2" Collet

Collet Chuck 1/4" (6mm)

Surface preparation, grind welds, spot sanding and light-duty finishing applications.

1.8 lbs. (0.816kg)

6.2 bar (90psi)

6.2 bar (90psi)

.9

20,000 rpm

116 liters/min (4.1 CFM)

83.2 dB

94.2 dB

<130 dB

5.92 m/s<sup>2</sup>

1.09 m/s<sup>2</sup>

Air oil 20#

Pad size 3" Collet

Collet Chuck 1/4" (6mm)

**NEW**

Put the power right in the palm of your hand with our Mini Angle Sanders

**MINI ANGLE SANDERS**

- A double-bearing spindle generates superb concentricity, reducing vibrations allowing for longer use and finer finishes
- Finesse your projects by having the ultimate control in both precision and power with the speed regulator
- Get better tool handling along with reduced fatigue with the ergonomic and streamlined non-slip grip



DESCRIPTION	STD. PKG.	PART #
<b>Mini Angle Sanders and Kits</b>		
2" Mini Angle Sander	1	662611 <b>50076</b>
2" Kit Includes:	1	662611 <b>50077</b>
• 1 – 2" Sander		
• 25 – 2" 36 Grit Blaze R980P 3-Ply TR Discs (662611 <b>62318</b> )		
• 50 – 2" Medium Grit Rapid Prep Non-Woven TR Discs (662610 <b>09190</b> )		
• 1 – 2" Medium Density Back-Up Pad (662610 <b>55103</b> )		
3" Mini Angle Air Sander	1	699573 <b>82154</b>
3" Kit Includes:	1	699573 <b>82155</b>
• 1 – 3" Sander		
• 25 – 3" 36 Grit Blaze R980P 3-Ply TR discs (662611 <b>62328</b> )		
• 25 – 3" Medium Grit Rapid Prep Non-Woven TR discs (662610 <b>17522</b> )		
• 1 – 3" Medium Density Back-Up Pad (662610 <b>55105</b> )		





Mini-flap discs are ideal for use in tight spaces. They feature layered flaps which wear away evenly during use exposing new abrasive grain. The lightweight plastic backing helps to absorb vibration. They can help eliminate the conventional 2-step process in grinding edges and removing welds and rust.

- Applications:** Grinding, stock removal, edge chamfering/beveling, weld blending, deburring/deflashing, rust removal, blending, cleaning, and finishing in small areas or tight spots.
- Size Range:** 2" and 3" Quick-Change
- Grit Range:** 36 – 120
- Abrasive Grain:** Ceramic Alumina, Zirconia Alumina
- Abrasive Flaps:** Polyester, Poly-cotton
- Attachment:** TR (Type III) and TS (Type II)
- Backing Plate Material:** Extra Heavy-Duty Plastic
- Machine Used:**



Best choice for beveling, blending, deburring, and stock removal in tight spaces



**BLAZE R980P CERAMIC ALUMINA**

- Premium ceramic alumina abrasive grain lasts 50% – 200% longer than many flap discs on stainless steel, cobalt, chrome, Inconel, titanium and other hard-to-grind materials
- Flexible, high-strength, plastic backing plates absorb vibration for optimized ergonomics
- Y-weight polyester flaps with a supersize grinding aid significantly improve life, grain retention, and fray resistance while providing a cool, noticeably faster cut rate

Better choice for blending, deburring, and stock removal in tight places



**BLUEFIRE R884P ZIRCONIA ALUMINA PLUS**

- High-performance zirconia alumina plus abrasive for aggressive cut and long life
- Flexible, high-strength, plastic backing plates absorb vibration for optimized ergonomics
- Poly-cotton flaps with semi-open coat provide improved durability and minimizes loading on aluminum



TIER:	BEST	BETTER	BEST	BETTER		
TRADENAME:	<b>BLAZE R980P</b>	<b>BLUEFIRE R884P</b>	<b>BLAZE R980P</b>	<b>BLUEFIRE R884P</b>		
ABRASIVE:	Ceramic Alumina	Zirconia Alumina Plus	Ceramic Alumina	Zirconia Alumina Plus		
FLAP:	Polyester	Polyester	Polyester	Polyester		
BACKING MATERIAL:	Extra Heavy-Duty Plastic	Extra Heavy-Duty Plastic	Extra Heavy-Duty Plastic	Extra Heavy-Duty Plastic		
ATTACHMENT:	TR (Type III)	TR (Type III)	TS (Type II)	TS (Type II)		
SIZE (D)	GRIT	STD. PKG.	PART #	PART #	PART #	PART #
2	36	10	776960 <b>90145</b>	776960 <b>90165</b>	776960 <b>90155</b>	776960 <b>90175</b>
	40	10	776960 <b>90146</b>	776960 <b>90166</b>	776960 <b>90156</b>	776960 <b>90176</b>
	60	10	776960 <b>90147</b>	776960 <b>90167</b>	776960 <b>90157</b>	776960 <b>90177</b>
	80	10	776960 <b>90148</b>	776960 <b>90168</b>	776960 <b>90158</b>	776960 <b>90178</b>
3	120	10	776960 <b>90149</b>	776960 <b>90169</b>	776960 <b>90159</b>	776960 <b>90179</b>
	36	10	776960 <b>90150</b>	776960 <b>90170</b>	776960 <b>90160</b>	776960 <b>90180</b>
	40	10	776960 <b>90151</b>	776960 <b>90171</b>	776960 <b>90161</b>	776960 <b>90181</b>
	60	10	776960 <b>90152</b>	776960 <b>90172</b>	776960 <b>90162</b>	776960 <b>90182</b>
	80	10	776960 <b>90153</b>	776960 <b>90173</b>	776960 <b>90163</b>	776960 <b>90183</b>
	120	10	776960 <b>90154</b>	776960 <b>90174</b>	776960 <b>90164</b>	776960 <b>90184</b>

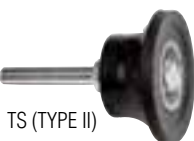

DESCRIPTION	MAX. RPM	STD. PKG.	TR (TYPE III)	TS (TYPE II)
<b>Mini Flap Disc Back-up Pads</b>				
2" and 3" Medium Density Back Up Pads	30,000	1	088341 <b>60172</b>	088341 <b>68539</b>



Tool-free, twist-on and -off fastening systems make fast work of disc changes to maximize productivity by minimizing downtime.

- Applications:** Fiber and NorKut trimmable hard plastic discs: welding, grinding and blending; heavy metal removal; light deburring and finishing  
Cloth discs: light- to medium-pressure grinding; blending, leveling and finishing applications; for use on contours or flat surfaces  
Diamond: Grinding ceramic, glass, composites, carbide and ceramic coatings, fiberglass, and reinforced plastics
- Size Range:** 9/16" – 4" diameter
- Grit Range:** 24 – 320
- Abrasive Grain:** Ceramic Alumina, Zirconia Alumina, Aluminum Oxide, Silicon Carbide, Diamond
- Backing:** Fiber, cloth, or polymer
- Cloth Flex:** 3-ply (more aggressive), 2-ply (standard)
- Attachment:** Type TS (II), Type TR (III), and Type TP (I)
- Back-up Pads:** Rubber with hardness variations for different applications



MINI ANGLE SANDER

### Coated Abrasive Quick-Change Disc Availability



**Fiber**

- The most heavy-duty discs with resin over resin construction on heavy-duty vulcanized fiber backing
- Premium grain for applications from heavy stock removal to surface blending



**Cloth 3-Ply**

- These heavy-duty, 3-ply polyester laminate construction discs are the most aggressive and durable cloth discs on the market



**NorKut**

- Unique polymer backing resists cracking and breakage and can be cut down up to the 1" core
- Use the cores to grind "pinch" welds and other hard-to-reach areas



**Cloth 2-Ply**

- Our standard 2-ply laminate construction creates an aggressive and durable cloth disc for flat surfaces



**Diamond**

- Unique, aggressive, diamond grain pattern on a flexible cloth backing

### Quick-Change Attachment Systems and Cross Reference Guide

Each system enables quick, safe disc changes, reducing downtime and operating expenses.

**Type TS (Type II)**

- Features a turn-on/turn-off style fastener
- Fastener is made of metal



**Type TR (Type III)**

- Features a roll-on/roll-off style fastener
- Fastener is made of plastic



**Type TP (Type I)**

- Features a snap-on/snap-off style fastener
- Fastener is made of nylon



NORTON MERIT	TS (Type II)	TR (Type III)	TP (Type I)
3M	Roloc TS/TSM	Roloc TR	Roloc TP
Standard	TS (SocAtt)	TR (Lockit)	TP (ClickOn)
Superior	Type S	Type R	–
Arc	Type S	Type R	Type P
Pferd	Type CD	Type CDR	–
Sait	SAIT-LOK	SAIT-LOK-R	–
Camel	Turn On	Roll On	–
Klingspor	QMC	QRC	–
Garryson	Type S	Type R	–

Material/Application-to-Product Recommendation Guide

	<b>BEST</b>	<b>BETTER</b>	<b>GOOD</b>
	<b>Blaze R980P</b>	<b>BlueFire R884P</b>	<b>Aluminum Oxide</b> <b>Silicon Carbide R422</b>
Stainless Steel / Titanium / Super Alloys	◆	◆	◆
Mild Carbon Steel / Welds		◆	◆
Ferrous Metals / Cast Iron		◆	◆
Brass / Bronze / Aluminum		◆	◆
Paint / Glue / Adhesive			◆
Concrete / Stone / Fiberglass			◆

Application/Grit Recommendation Guide

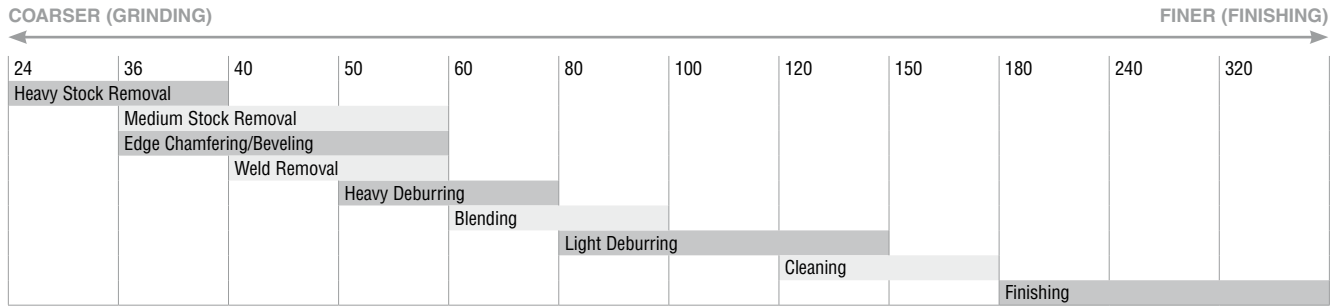

Cross Reference Guide

	TOTAL PERFORMANCE			INITIAL PRICE	
	<b>BEST</b>	<b>BETTER</b>	<b>GOOD</b>		
Abrasive Backing	<b>Ceramic Alumina</b>	<b>Ceramic Alumina</b>	<b>Zirconia Alumina</b>	<b>Aluminum Oxide</b>	<b>Silicon Carbide</b>
<b>NORTON</b>	<b>Fiber</b>	<b>Cloth</b>	<b>Cloth</b>	<b>Cloth</b>	<b>Cloth</b>
3M	<b>Blaze F980</b>	<b>Blaze R980P</b>	<b>BlueFire R884P</b>	<b>R422</b>	<b>R422</b>
	782C, 785C, 787C, 982C, 985C, 987C, 988C	963G/H, 966F, 967F, 997F, 984F, 784F, 947A	561D	361F, 363F	421A, 441D, 461F
Standard	Ceramic, Ceramic Pro	Ceramic Pro, Ceramic	Zirconia	A/O Extra, A/O Pro	Silicon Carbide
Superior	—	Ceramic G.A.	Premium Zirc	A/O with Grinding Aid	—
Arc	—	—	Zirconia/Y Standard	A/O/X Plus Coolant	—
Pferd	CO, CO Cool	Ceramic	ZA Z	Aluminum Oxide A-Plus, Aluminum Oxide A-INOX-FORTE	Silicon Carbide SiC
Sait	7S,7A, 9S	—	Z	3A	C-W
Camel	Ceramic	—	Zirconia AO	—	—
Klingspor	CS570, FS966	CS610	Alumina Zirconia	—	CS333X
Garryson	—	Ceramic	—	—	—

Best choice for tough applications and stainless steel



## BLAZE F980 CERAMIC ALUMINA FIBER

- 100% ceramic grain constantly exposes sharper edges to deliver highest productivity at lowest overall costs vs. competitive lower-ratio ceramic discs
- Strong fiber backing, heavier and more rigid than conventional cloth discs, adds strength and tear resistance, and allows additional pressure for better results when grinding difficult materials
- Advanced self-lubricating grain treatment provides coolest cut and significantly faster cut rates; excels on hard-to-grind materials like 300 and 400 Series stainless and exotic alloys

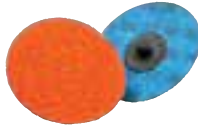

TIER: **BEST**  
 TRADENAME: **BLAZE F980**  
 ABRASIVE: Ceramic Alumina  
 BACKING: Fiber – Heavy Duty  
 OTHER: Supersize  
 ATTACHMENT: TR (Type III)



SIZE (D)	GRIT	STD. PKG.	PART #
2	24	25	776960 <b>90139</b>
	36	25	662610 <b>58704</b>
	50	25	662610 <b>58705</b>
	60	25	662610 <b>58706</b>
	80	25	662610 <b>58707</b>
3	24	25	776960 <b>90140</b>
	36	25	662610 <b>58708</b>
	50	25	662610 <b>58709</b>
	60	25	662610 <b>58711</b>
	80	25	662610 <b>58712</b>

Quick-Change back-up pads shown at the end of the Quick-Change Disc section.





Best choice for tough applications, titanium, super alloys, and stainless steel (3-ply) or contoured surfaces (2-ply)

## BLAZE R980P CERAMIC ALUMINA

- 100% ceramic grain constantly exposes sharper edges to deliver highest productivity at lowest overall costs vs. competitive lower-ratio ceramic discs
- Improved resin bond system maximizes grain retention for longer product life
- Advanced self-lubricating grain treatment provides coolest cut with significantly faster cut rates while minimizing loading on hard-to-grind materials



Better choice for soft metals, wood, stainless steel, and carbon

## BLUEFIRE R884P ZIRCONIA ALUMINA

- Premium, versatile, self-sharpening zirconia plus grain provides aggressive cut and up to 30% longer life vs. competitive zirconia discs
- Semi-open coat minimizes loading on soft metals (aluminum, brass, and bronze) and wood, as well as stainless and carbon steels
- Durable Y-weight, polyester waterproof backing stands up to demanding applications: high-pressure and hard-to-grind exotic alloys



Better choice for stainless steel, titanium and other exotic alloys

## R801 ZIRCONIA ALUMINA PLUS

- Self-sharpening, zirconia alumina abrasive with grinding aid provides cooler cut, and longer life on hard-to-grind materials
- Durable, Y-weight, 2-ply polyester waterproof blend back stands up to these demanding applications
- Minimized heat build-up allows these discs to outlast conventional aluminum oxide and zirconia alumina discs in many applications



Good choice when initial price is the primary consideration

## ALUMINUM OXIDE

- Versatile aluminum oxide abrasive for aggressive cut and longer life than competitive aluminum oxide discs
- Durable Y-weight 2-ply polyester backing and coating for additional life and faster cut rate on moderately-demanding applications
- Good choice when initial price is the primary purchasing consideration



Good choice for non-ferrous materials

## R422 SILICON CARBIDE

- Sharp, silicon carbide abrasive provides high initial cut and penetration to resist loading on soft metals
- Strong, X-weight, 2-ply cotton backing construction for extended durability and reduced edge wear
- When completion time is important, sharp silicon carbide abrasive gets non-ferrous blending jobs done quickly

Ceramic Alumina Quick-Change Cloth Discs



TIER:	BEST	BEST	BEST	BEST
TRADENAME:	<b>BLAZE R980P</b>	<b>BLAZE R980P</b>	<b>BLAZE R980P</b>	<b>BLAZE R980P</b>
ABRASIVE:	Ceramic Alumina	Ceramic Alumina	Ceramic Alumina	Ceramic Alumina
BACKING:	Polyester 3-Ply Heavy-Duty	Polyester 3-Ply Heavy-Duty	Polyester 2-Ply Standard	Polyester 2-Ply Standard
OTHER:	Supersize TS (Type II)	Supersize TR (Type III)	Supersize TS (Type II)	Supersize TR (Type III)
ATTACHMENT:				

SIZE (D)	GRIT	STD. PKG.	PART #	PART #	PART #	PART #
1-1/2	36	100	662611 <b>62307</b>	662611 <b>62308</b>	636425 <b>95401</b>	
	50	100	662611 <b>62309</b>	662611 <b>62310</b>	636425 <b>95446</b>	
	60	100	662611 <b>62311</b>	662611 <b>62312</b>	636425 <b>95447</b>	636425 <b>95468</b>
	80	100	662611 <b>62313</b>	662611 <b>62314</b>	636425 <b>95450</b>	
	120	100	662610 <b>43379</b>	662610 <b>43380</b>	662610 <b>43416</b>	
2	36	25	662611 <b>62317</b>	662611 <b>62318</b>	636425 <b>95452</b>	636425 <b>95470</b>
	50	25	662611 <b>62319</b>	662611 <b>62320</b>	636425 <b>95456</b>	636425 <b>95472</b>
	60	25	662611 <b>62321</b>	662611 <b>62322</b>	636425 <b>95458</b>	636425 <b>95476</b>
	80	25	662611 <b>62323</b>	662611 <b>62324</b>	636425 <b>95459</b>	636425 <b>95478</b>
	100	25	662610 <b>43382</b>	662610 <b>43383</b>	662610 <b>43418</b>	662610 <b>43419</b>
	120	25	662610 <b>43384</b>	662610 <b>43386</b>	662610 <b>43420</b>	662610 <b>43421</b>
3	36	25	662611 <b>62327</b>	662611 <b>62328</b>	636425 <b>95460</b>	636425 <b>95479</b>
	50	25	662611 <b>62329</b>	662611 <b>62330</b>	636425 <b>95462</b>	636425 <b>95480</b>
	60	25	662611 <b>62331</b>	662611 <b>62332</b>	636425 <b>95463</b>	636425 <b>95481</b>
	80	25	662611 <b>62333</b>	662611 <b>62334</b>	636425 <b>95464</b>	636425 <b>95493</b>
	100	25	662610 <b>43389</b>	662610 <b>43390</b>	662610 <b>43422</b>	662610 <b>43423</b>
	120	25	662610 <b>43391</b>	662610 <b>43392</b>	662610 <b>43424</b>	662610 <b>43425</b>

Quick-Change back-up pads shown at the end of the Quick-Change Disc section.



Zirconia Alumina Quick-Change Cloth Discs



TIER:	<b>BETTER</b>	<b>BETTER</b>	<b>BETTER</b>	<b>BETTER</b>	<b>BETTER</b>
TRADENAME:	<b>BLUEFIRE R884P</b>	<b>BLUEFIRE R884P</b>	<b>R801 ZIRC PLUS</b>	<b>R801 ZIRC PLUS</b>	<b>R801 ZIRC PLUS</b>
ABRASIVE:	Zirconia Alumina	Zirconia Alumina	Zirconia Alumina	Zirconia Alumina	Zirconia Alumina
BACKING:	Polyester 2-Ply Standard	Polyester 2-Ply Standard	Polyester 2-Ply Standard	Polyester 2-Ply Standard	Polyester 2-Ply Standard
OTHER:			Supersize	Supersize	Supersize
ATTACHMENT:	TS (Type II)	TR (Type III)	TS (Type II)	TR (Type III)	TP (Type I)



SIZE (D)	GRIT	STD. PKG.	PART #	PART #	PART #*	PART #*	PART #*
1	36	100				088341 <b>67093</b> NS	
	40	100			088341 <b>67052</b> NS	088341 <b>67094</b> NS	
	50	100				088341 <b>67095</b> NS	088341 <b>67011</b> NS
	60	100	662611 <b>38608</b>			088341 <b>67096</b> NS	088341 <b>67012</b> NS
	80	100	662611 <b>38607</b>			088341 <b>67097</b>	088341 <b>67013</b> NS
	120	100				088341 <b>67099</b>	088341 <b>67015</b> NS
1-1/2	36	100	662611 <b>38624</b>	662611 <b>21041</b>		088341 <b>67102</b>	088341 <b>67018</b> NS
	50	100				088341 <b>67103</b>	088341 <b>67019</b> NS
	60	100	662611 <b>38621</b>	662611 <b>21043</b>	088341 <b>67061</b>	088341 <b>67104</b>	
	80	100	662611 <b>38620</b>	662611 <b>21044</b>	088341 <b>67062</b>	088341 <b>67106</b>	
	120	100					
2	24	100	662611 <b>38638</b> *	662611 <b>38672</b> *		088341 <b>67107</b>	088341 <b>67023</b>
	36	100	662611 <b>38637</b> *	662611 <b>38671</b>	088341 <b>67065</b>	088341 <b>67108</b>	
	40	100			088341 <b>67066</b>	088341 <b>67109</b>	088341 <b>67025</b>
	50	100	662611 <b>38635</b> *	662611 <b>38670</b> *	088341 <b>65583</b>	088341 <b>67110</b>	088341 <b>67026</b>
	60	100	662611 <b>38634</b> *	662611 <b>21048</b> *	088341 <b>67068</b>	088341 <b>67111</b>	088341 <b>67027</b>
	80	100	662611 <b>38633</b> *	662611 <b>21049</b> *	088341 <b>67069</b>	088341 <b>67113</b>	088341 <b>67029</b>
	120	100			088341 <b>67071</b>		
3	24	50	662611 <b>38665</b> *	662611 <b>38675</b> *		088341 <b>67114</b>	088341 <b>67030</b>
	36	50	662611 <b>38664</b> *	662611 <b>38674</b> *	088341 <b>67072</b>	088341 <b>67116</b>	088341 <b>67032</b>
	40	50			088341 <b>67073</b>	088341 <b>67117</b>	088341 <b>67033</b>
	50	50	662611 <b>38662</b> *	662611 <b>38673</b> *	088341 <b>67074</b>	088341 <b>67118</b>	088341 <b>67034</b>
	60	50	662611 <b>38661</b> *	662611 <b>21053</b> *	088341 <b>67075</b>	088341 <b>67120</b>	
	80	50	662611 <b>38660</b> *	662611 <b>21054</b> *	088341 <b>67076</b>		
	120	50			088341 <b>67078</b>		
4	36	50	662611 <b>38683</b> *		088341 <b>67079</b>		
	50	50	662611 <b>38681</b> *				
	60	50	662611 <b>37343</b> *				088341 <b>67040</b> NS
	80	50	662611 <b>38679</b> *		088341 <b>67083</b> NS		
	120	50			088341 <b>67085</b> NS		

\* Standard Package = 25 discs

NS Non-stock, contact your Norton representative for current order quantities and lead-times.

Quick-Change back-up pads shown at the end of the Quick-Change Disc section.





Quick-Change Test Kit "D"

- Part # 088341**65001**
- Includes 150 discs, assorted grits, in 1", 2", and 3" diameters and 3" back-up pads
- Primarily aluminum oxide cloth quick-change discs
- Several zirconia alumina and aluminum oxide FlexEdge discs are included



Aluminum Oxide Quick-Change Cloth Discs



TIER:	<b>GOOD</b>	<b>GOOD</b>	<b>GOOD</b>
ABRASIVE:	Aluminum Oxide	Aluminum Oxide	Aluminum Oxide
BACKING:	Polyester	Polyester	Polyester
	2-Ply Standard	2-Ply Standard	2-Ply Standard
ATTACHMENT:	TS (Type II)	TR (Type III)	TP (Type I)
			

SIZE (D)	GRIT	STD. PKG.	PART #	PART #	PART #	
3/4	40	100			699573 <b>99739</b>	
	50	100	699573 <b>99604</b>		699573 <b>99740</b>	
	60	100	699573 <b>99605</b>	699573 <b>99673</b>	699573 <b>99741</b>	
	80	100	699573 <b>99606</b>	699573 <b>99674</b>	699573 <b>99742</b>	
1	36	100	699573 <b>99614</b>	699573 <b>99682</b>	699573 <b>99750</b>	
	40	100			699573 <b>99751</b>	
	50	100	699573 <b>99616</b>		699573 <b>99752</b>	
	60	100	699573 <b>99617</b>	699573 <b>99685</b>	699573 <b>99753</b>	
	80	100	699573 <b>99618</b>	699573 <b>99686</b>	699573 <b>99754</b>	
	100	100	699573 <b>99619</b>	699573 <b>99687</b>	699573 <b>99755</b>	
	120	100	699573 <b>99620</b>	699573 <b>99688</b>	699573 <b>99756</b>	
	180	100	699573 <b>99622</b>	699573 <b>99690</b>	699573 <b>99758</b>	
240	100	699573 <b>99623</b>	699573 <b>99691</b>	699573 <b>99759</b>		
1-1/2	36	100	699573 <b>99626</b>	699573 <b>99694</b>	699573 <b>99762</b>	
	40	100	699573 <b>99627</b>	699573 <b>99695</b>	699573 <b>99763</b>	
	50	100	699573 <b>99628</b>	699573 <b>99696</b>	699573 <b>99764</b>	
	60	100	699573 <b>99629</b>	699573 <b>99697</b>	699573 <b>99765</b>	
	80	100	699573 <b>99630</b>	699573 <b>99698</b>	699573 <b>99766</b>	
	100	100	699573 <b>99631</b>	699573 <b>99699</b>		
	120	100	699573 <b>99632</b>	699573 <b>99700</b>	699573 <b>99768</b>	
	150	100			699573 <b>99769</b>	
	180	100	699573 <b>99634</b>	699573 <b>99702</b>	699573 <b>99770</b>	
	240	100	699573 <b>99635</b>	699573 <b>99703</b>		
2	24	100	699573 <b>99637</b>	699573 <b>99705</b>	699573 <b>99773</b>	
	36	100	699573 <b>99638</b>	699573 <b>99706</b>	699573 <b>99774</b>	
	40	100	699573 <b>99639</b>	699573 <b>99707</b>	699573 <b>99775</b>	
	50	100	699573 <b>99640</b>	699573 <b>99708</b>	699573 <b>99776</b>	
	60	100	699573 <b>99641</b>	699573 <b>99709</b>	699573 <b>99777</b>	
	80	100	699573 <b>99642</b>	699573 <b>99710</b>	699573 <b>99778</b>	
	100	100	699573 <b>99643</b>	699573 <b>99711</b>	699573 <b>99779</b>	
	120	100	699573 <b>99644</b>	699573 <b>99712</b>	699573 <b>99780</b>	
	150	100	699573 <b>99645</b>	699573 <b>99713</b>	699573 <b>99781</b>	
	180	100	699573 <b>99646</b>	699573 <b>99714</b>	699573 <b>99782</b>	
	240	100	699573 <b>99647</b>	699573 <b>99715</b>	699573 <b>99783</b>	
	320	100	699573 <b>99648</b>	699573 <b>99716</b>	699573 <b>99784</b>	
	3	24	50	699573 <b>99649</b>	699573 <b>99717</b>	699573 <b>99785</b>
		36	50	699573 <b>99650</b>	699573 <b>99718</b>	699573 <b>99786</b>
40		50	699573 <b>99651</b>	699573 <b>99719</b>	699573 <b>99787</b>	
50		50	699573 <b>99652</b>	699573 <b>99720</b>	699573 <b>99788</b>	
60		50	699573 <b>99653</b>	699573 <b>99721</b>	699573 <b>99789</b>	
80		50	699573 <b>99654</b>	699573 <b>99722</b>	699573 <b>99790</b>	
100		50	699573 <b>99655</b>	699573 <b>99723</b>	699573 <b>99791</b>	
120		50	699573 <b>99656</b>	699573 <b>99724</b>	699573 <b>99792</b>	
150		50	699573 <b>99657</b>	699573 <b>99725</b>		
180		50	699573 <b>99658</b>	699573 <b>99726</b>	699573 <b>99794</b>	
240		50	699573 <b>99659</b>	699573 <b>99727</b>	699573 <b>99795</b>	
320		50	699573 <b>99660</b>	699573 <b>99728</b>	699573 <b>99796</b>	
4		36	50	699573 <b>99661</b>	699573 <b>99729</b>	
		50	50		699573 <b>99731</b>	
	60	50	699573 <b>99664</b>		699573 <b>99800</b>	
	80	50		699573 <b>99733</b>	699573 <b>99801</b>	

Quick-Change back-up pads shown at the end of the Quick-Change Disc section.

Silicon Carbide Quick-Change Cloth Discs



TIER:	GOOD	GOOD	GOOD
TRADENAME:	<b>R422</b>	<b>R422</b>	<b>R422</b>
ABRASIVE:	Silicon Carbide	Silicon Carbide	Silicon Carbide
BACKING:	Cotton Standard	Cotton Standard	Cotton Standard
ATTACHMENT:	TS (Type II)	TR (Type III)	TP (Type I)



SIZE (D)	GRIT	STD. PKG.	PART #	PART #	PART #
2	40	100	088341 <b>65252</b>	088341 <b>64275</b>	
	60	100	088341 <b>65254</b>	088341 <b>64163</b>	088341 <b>62168</b>
	80	100	088341 <b>65255</b>	088341 <b>66155</b>	088341 <b>62169</b>
	120	100		088341 <b>64837</b>	088341 <b>62171</b>
	180	100	088341 <b>65259</b>	088341 <b>67313</b>	088341 <b>62173</b>
3	40	50	088341 <b>65267</b>	088341 <b>64277</b>	
	60	50		088341 <b>64850</b>	
	80	50		088341 <b>66159</b>	088341 <b>62188</b>
	120	50	088341 <b>65272</b>	088341 <b>66160</b>	088341 <b>62190</b>
	180	50	088341 <b>65274</b>	088341 <b>68177</b>	

Quick-Change back-up pads shown at the end of the Quick-Change Disc section.

Some part number are non-stock, contact your Norton representative for status, order quantities and lead-times.

Specialty Quick-Change Discs

Better choice for hard-to-grind areas where flexibility is not required



NORKUT ZIRCONIA ALUMINA POLYMER

- Durable zirconia alumina grain is resin bonded to a unique polymer backing which resists cracking and breaking; can be trimmed to the 1 Inch core
- Used with a quick change mandrel: 7/16-20 threaded for hand-held pneumatic grinders or 1/4 inch mandrel for automotive drills
- Use for deburring and blending; use the core to grind pinch welds and other hard-to-reach areas

TIER:	<b>BETTER</b>
TRADENAME:	<b>NORKUT</b>
ABRASIVE:	Zirconia Alumina
BACKING:	Extra HD Polymer
ATTACHMENT:	Threaded Hole

SIZE (D)	GRIT	STD. PKG.	PART #
<b>NorKut Discs</b>			
3	24	20	636425 <b>03656</b>
	36	20	636425 <b>03657</b>
	50	20	636425 <b>03658</b>

TIER:	<b>BETTER</b>
ATTACHMENT:	Threaded Hole

SIZE (D)	STD. PKG.	PART #
<b>Mandrels</b>		
7/16-20 Mandrel	5	636425 <b>03659</b>
1/4" Mandrel	5	636425 <b>03660</b>

Better choice for improved cut rate and finish on ceramics, glass, fiberglass, composites, carbide, and other tough metals and coatings

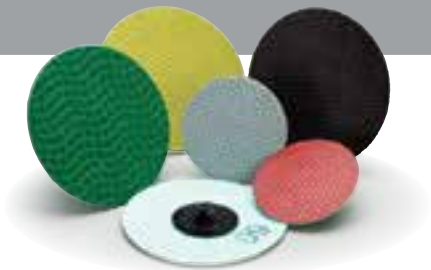

D7210 DIAMOND QUICK-CHANGE TR (TYPE III)

- Unique, durable diamond abrasive pattern increases life and lowers costs versus standard coated and diamond discs; color-coded backing for easy grit/application identification
- Removes rust and scale on other material; producing metallurgical stamps and coupons

SIZE (D)	COLOR	GRIT	STD. PKG.	PART #
<b>Flexible Diamond Coated Quick-Change TR (Type III) Discs</b>				
2"	Green	60	12	662603 <b>11778</b>
	Black	120	12	662603 <b>11779</b>
	Red	200	12	662603 <b>11780</b>
	Yellow	400	12	662603 <b>11781</b>
	White	800	12	662603 <b>11782</b>

SIZE (D)	COLOR	GRIT	STD. PKG.	PART #
<b>Flexible Diamond Coated Quick-Change TR (Type III) Discs</b>				
3"	Green	60	12	662603 <b>11783</b>
	Black	120	12	662603 <b>11784</b>
	Yellow	400	12	662603 <b>11786</b>



Non-woven quick-change discs are a combination of strong synthetic mesh and quality abrasives, bonded together by a smear-resistant adhesive. The open construction of the non-woven material enables aggressive cutting action and improved surface finish while maintaining its non-loading feature.

- Applications:** Medium-light stock removal, beveling, deburring/deflashing, rust removal, blending, cleaning and finishing, polishing, and decorative finishing
- Size Range:** 3/4" – 4" diameter
- Grit Range:** X-Coarse, Coarse, Medium, Fine, Very Fine, Super Fine
- Abrasive Grain:** Ceramic Alumina, Engineered Aluminum Oxide, Aluminum Oxide, Silicon Carbide
- Attachment:** Quick-Change Type TR (Type III), Type TS (Type II)
- Back-up Pads:** Rubber with hardness variations for different applications
- Machine Used:**



MINI ANGLE SANDER

### Quick-Change Attachment Systems and Cross Reference Guide

Each system enables quick, tool-free, safe disc changes, reducing downtime and operating expenses.

**Type TS (Type II)**

- Features a turn-on/turn-off style fastener
- Fastener is made of metal



**Type TR (Type III)**

- Features a roll-on/roll-off style fastener
- Fastener is made of plastic

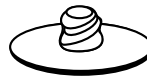

NORTON	TS	TR
3M	Roloc TS/TSM	Roloc TR
Standard	TS (SocAtt)	TR (Lockit)
Superior	Type S	Type R
Arc	Type S	Type R
Pferd	Type CD	Type CDR
Sait	SAIT-LOK	SAIT-LOK-R
Camel	Turn On	Roll On
Klingspor	QMC	QRC
Garryson	Type S	Type R

### Application/Grit Recommendation Guide

← MOST AGGRESSIVE LEAST AGGRESSIVE →

NORTON MERIT	Rapid Strip	Vortex Rapid Blend Deburring & Blending	Vortex Rapid Prep	Rapid Prep	HS Buffing, Buffing
Scale Removal	Best Choice				
Stock Removal	Best Choice	Second Choice			
Heavy Deburring	Second Choice	Best Choice			
Light Deburring		Best Choice	Second Choice		
Light Finishing			Best Choice	Second Choice	
Blending			Best Choice	Second Choice	
Cleaning			Second Choice	Best Choice	
Finishing				Best Choice	Second Choice

### Cross Reference Guide

NORTON MERIT	STRIPPING		HEAVY/LIGHT DEBURRING		LIGHT DEBURRING/BLENDING/CLEANING/FINISHING		
	BEST	BETTER	BEST	BETTER	BEST	BETTER	BETTER
	<b>Blaze Rapid Strip</b>	<b>Rapid Strip</b>	<b>Vortex Rapid Blend</b>	<b>Rapid Blend, Deburring &amp; Blending</b>	<b>Vortex Rapid Prep</b>	<b>Rapid Prep</b>	<b>HS Buffing, Buffing</b>
3M	Clean and Strip XT PRO, Clean and Strip XT PRO Extra Cut	Clean & Strip Clean Strip XT	Deburr and Finish PRO	EXL Unitized	SE	Surf Cond, SL	-
Standard	-	Cleaning Disc	-	500-900 Series Unitized	-	FE, GP, RC	Buff & Blend - HS, Buff & Blend
Fiberal/SIA	-	-	-	-	-	Meteor, Type B & C	-
Superior	-	Type R	-	XL Unitized	-	FD, GD, CC	HS, HD A/O
Arc	-	Arcstrip	-	-	-	Surface Cond	Blend & Finish
Pferd	-	Policlean	-	-	-	Finishing Disc - Hard & Soft	-
Sait	-	SAIT-Strip	-	-	-	HD, GP	Sand-Light Blending
Camel	-	EZ Strip - Black	-	-	-	-	-
Klingspor	-	-	-	-	-	-	-
Garryson	-	-	-	-	-	Surface Cond	-
Bibielle	-	Strip-It Black	-	BUR Unitized	-	DCR	-

### Abrasive/Grit/Density Key

ABRASIVE	SILICON CARBIDE			ALUMINUM OXIDE		CERAMIC ALUMINA
	SHARPER, FINER/BRIGHTER SCRATCH PATTERN			MORE DURABLE, LONGER LASTING, POLISHED FINISH		
GRIT SIZE	XC (50)	C (60-80)	M (100-150)	F (180-220)	VF (240-360)	SF (400-600)
	FASTER, AGGRESSIVE CUT, ROUGHER FINISH			REDUCED CUT RATE, FINER FINISH		
DENSITY	2			9		
	SOFT, OPEN, CONFORMABLE, LESS BURNING/LOADING			HARDER, MORE DURABLE, FASTER CUTTING, BETTER FINISH		

3D Quick-Change Stripping Discs



Best choice for removing coatings on a variety of substrates, such as wood, metal and plastics

**BLAZE RAPID STRIP CERAMIC ALUMINA**

- Blaze ceramic grain cuts 2X faster than competitive discs; leaves a thoroughly cleaned surface, ensuring excellent adhesion in subsequent processes such as coating, painting and soldering
- Open web construction for minimal loading; great alternative to wire brushes
- Rapid Strip material provides a unique combination of aggressive performance, long life, and improved finish



Better choice for removing coatings on a variety of substrates, such as wood, metal and plastics

**RAPID STRIP SILICON CARBIDE**

- Sharp silicon carbide abrasive provides fast aggressive cutting action
- Open web construction for minimal loading; great alternative to wire brushes
- Advanced resin bond prevents shedding, snagging, gouging, and rework



TIER: **BEST**  
 TRADENAME: **BLAZE RAPID STRIP**  
 ABRASIVE: Ceramic Alumina  
 GRADE: XC  
 ATTACHMENT: TR (Type III)

TIER: **BETTER**  
 TRADENAME: **RAPID STRIP**  
 ABRASIVE: Silicon Carbide  
 GRADE: XC  
 ATTACHMENT: TR (Type III)



SIZE (DIAMETER)	MAX. RPM	STD. PKG.	PART #	STD. PKG.	PART #
2 x 1/2	15,500	25	666233 <b>03912</b>	10	662610 <b>13402</b>
3 x 1/2	12,000	25	662610 <b>96557</b>	10	662610 <b>13403</b>
4 x 1/2 TR+	8,000	5	666233 <b>03921*</b>	5	662610 <b>16580*</b>

\*TR+ attachment show in the group image above

For unified wheels with arbor holes or spindle mounts, see Non-woven Unified Wheels section. Quick-Change back-up pads shown at the end of this section.

3D Quick-Change Deburring & Blending Discs

Best technology for heavy deburring and finishing



**BLAZE RAPID BLEND CERAMIC ALUMINA**

- Blaze SG ceramic alumina grain provides quickest cut rate and up to 8X longer life than competitive aluminum oxide discs
- Superior resin chemistry resists shedding when used on sharp edges; ideal for deburring
- Abrasive is distributed throughout the entire disc (top, bottom and side) so all three faces can be used versus competitive discs with one bottom layer of abrasive

Best choice for weld blending, polishing and deburring



**VORTEX RAPID BLEND ALUMINUM OXIDE**

- Patented Vortex agglomerated aluminum oxide grain provides the cutting power of a coarser grit with the finish of finer grits
- Special resin bond for consistent performance with no smearing
- Abrasive is distributed throughout the entire disc (top, bottom and side) so all three faces can be used versus competitive discs with one bottom layer of abrasive

Better choice for light deburring, blending, and cleaning



**RAPID BLEND NEX ALUMINUM OXIDE**

- Quality aluminum oxide delivers durability and long life
- Resin formula delivers smear-free finishes
- Abrasive is distributed throughout the entire disc (top, bottom and side) so all three faces can be used – versus competitive discs' one bottom layer of abrasive

3D Quick-Change Deburring & Blending TS Discs



TIER:	BEST	BEST
TRADENAME:	<b>BLAZE RAPID BLEND</b>	<b>VORTEX RAPID BLEND</b>
ABRASIVE:	Ceramic Alumina	Engineered Aluminum Oxide
ATTACHMENT:	TS (Type II)	TS (Type II)



SIZE (D x T)	ABRASIVE	GRIT	DENSITY	MAX. RPM	STD. PKG.	PART #	PART #
1 x 1/4	Ceramic Alumina	XC	1	35,000	100	666233 <b>13920</b>	
1-1/2 x 1/4	Ceramic Alumina	XC	1	35,000	80	666233 <b>13922</b>	
2 x 1/4	Ceramic Alumina	XC	1	22,000	25	666233 <b>13925</b>	
	Aluminum Oxide	M	1	22,000	25		662544 <b>97070</b>
3 x 1/4	Ceramic Alumina	XC	1	15,000	25	666233 <b>13931</b>	
	Aluminum Oxide	M	1	15,000	25		662544 <b>97069</b>

3D Quick-Change Deburring & Blending Discs *continued*

3D Quick-Change Deburring & Blending TR Discs



TIER:	BEST	BEST	BETTER
TRADENAME:	<b>BLAZE RAPID BLEND</b>	<b>VORTEX RAPID BLEND</b>	<b>RAPID BLEND NEX</b>
ABRASIVE:	Ceramic Alumina	Engineered Aluminum Oxide	Aluminum Oxide
ATTACHMENT:	TR (Type III)	TR (Type III)	TR (Type III)

SIZE (D x T)	ABR.	GRIT	DENSITY	MAX. RPM	STD. PKG.	PART #	PART #	PART #	
1 x 1/4	Ceramic Alumina	XC	1	35,000	100	6662331 <b>3919</b>			
1-1/2 x 1/4	Ceramic Alumina	XC	1	35,000	80	6662331 <b>3921</b>			
2 x 1/8	Aluminum Oxide	M	4-6	22,000	60		662544 <b>25632</b>		
	Aluminum Oxide	M	7-9	22,000	60		662544 <b>33509</b>		
2 x 3/16	Aluminum Oxide	M	2-3	22,000	60		662544 <b>28236</b>		
2 x 1/4	Ceramic Alumina	XC	1	22,000	25	6662331 <b>3923</b>			
	Aluminum Oxide	C	7-9	22,000	60			662610 <b>14921</b>	
	Aluminum Oxide	M	1	22,000	25		662544 <b>97067</b>		
	Aluminum Oxide	M	2-3	22,000	60		662544 <b>28237</b>	662610 <b>14897</b>	
	Aluminum Oxide	M	4-6	22,000	60		662544 <b>13660</b>	662610 <b>14911</b>	
	Aluminum Oxide	M	7-9	22,000	60		662544 <b>433510</b>	662610 <b>14935</b>	
	Silicon Carbide	F	2	22,000	60			662610 <b>14889</b>	
	Silicon Carbide	F	3	22,000	60			662610 <b>17306</b>	
	3 x 1/8	Aluminum Oxide	M	4-6	15,000	40		662610 <b>93556</b>	
		Aluminum Oxide	M	7-9	15,000	40		662610 <b>90909</b>	
3 x 3/16	Aluminum Oxide	M	7-9	15,000	40		662544 <b>28239</b>		
3 x 1/4	Ceramic Alumina	XC	1	15,000	25	6662331 <b>3930</b>			
	Aluminum Oxide	C	7-9	15,000	40			662610 <b>14922</b>	
	Aluminum Oxide	M	1	15,000	25		662544 <b>97068</b>		
	Aluminum Oxide	M	2-3	15,000	40		662544 <b>28238</b>	662610 <b>14898</b>	
	Aluminum Oxide	M	4-6	15,000	40		662544 <b>13661</b>	662610 <b>14912</b>	
	Aluminum Oxide	M	7-9	15,000	40		662544 <b>06395</b>	662610 <b>14936</b>	
	Aluminum Oxide	F	4-6	15,000	40			662610 <b>15419</b>	
	Silicon Carbide	F	2	15,000	40			662610 <b>14890</b>	
	Silicon Carbide	F	3	15,000	40			662610 <b>16005</b>	

For unified wheels with arbor holes or spindle mounts, see the Non-woven Unified Wheel section. Quick-Change back-up pads shown at the end of this section.

Quick-Change Surface Preparation Discs

Best choice for aggressive stock removal and blending in one step



RAPID PREP XHD

- Coarse and Medium discs solve your most aggressive stock removal and blending challenges, remove weld lines, weld spatter, weld discoloration and blend surfaces in a single step
- Improve cut control and surface blending over traditional coated discs with our unique combination of a conformable fiber matrix and premium ceramic grain
- XHD Coarse discs for aggressive weld removal and surface blending on steels and Medium discs on softer metals/ alloys

TIER: **BEST**  
 TRADENAME: **RAPID PREP XHD**  
 ABRASIVE: Ceramic Alumina  
 ATTACHMENT: TR (Type III)



SIZE (DIAMETER)	MAX. RPM	STD. PKG.	PART #
<b>Coarse</b>			
2	20,000	50	662611 <b>70271</b>
3	18,000	25	662611 <b>70273</b>
4	12,000	25	662611 <b>70274</b>
<b>Medium</b>			
2	20,000	50	662611 <b>70285</b>
3	18,000	25	662611 <b>70286</b>
4	12,000	25	662611 <b>70287</b>





Quick-Change Surface Preparation Discs



Best choice for finishing and blending applications

VORTEX RAPID PREP





- Proprietary engineered Vortex aluminum oxide abrasive grain and coating method combine maximum cutting speed with the consistent finish of finer grits to reduce process times by 50+% by combining multiple grit sequences to 1 step
- Premium high-loft nylon fiber bonded to a strong nylon scrim backing allows a thick layer of resin bond and grain for extended life and provides added durability and stiffness
- Proprietary Clean Bond resin technology guarantees smear-free finishes even on high nickel content alloys and reduces loading on aluminum and other soft metals



Better choice for finishing and blending applications

RAPID PREP ALUMINUM OXIDE

- Quality aluminum oxide abrasive grain coating provides up to 20% higher cut rate and 50% better performance than competitive products
- Thick layer of grain throughout the product extends life; grain does not sit on top of fibers as it does with other competitive products
- Proprietary Clean Bond resin technology guarantees smear-free finishes even on high nickel content alloys and reduces loading on aluminum and other soft metals

TIER:	BEST	BETTER	BEST	BETTER
TRADENAME:	<b>VORTEX RAPID PREP</b>	<b>RAPID PREP</b>	<b>VORTEX RAPID PREP</b>	<b>RAPID PREP</b>
ABRASIVE:	Engineered A/O	Aluminum Oxide	Engineered A/O	Aluminum Oxide
ATTACHMENT:	TR (Type III)	TR (Type III)	TS (Type II)	TS (Type II)
				

SIZE (DIAM.)	MAX. RPM	STD. PKG.	PART #	PART #	PART #	PART #
<b>Extra Coarse</b>						
3/4	25,000	50	666233 <b>25001</b>	666233 <b>40002</b>	666233 <b>35324</b>	
1	25,000	50	666233 <b>25004</b>		666233 <b>25003</b>	666233 <b>40006</b>
1-1/2	20,000	50	666233 <b>25007</b>	666233 <b>40011</b>	666233 <b>25006</b>	666233 <b>40010</b>
2	20,000	50	666233 <b>35326</b>	662610 <b>16373</b>	666233 <b>35325</b>	662610 <b>17819</b>
3	18,000	25	666233 <b>35327</b>	662610 <b>16994</b>	666233 <b>25010</b>	662610 <b>17818</b>
4	12,000	25	666233 <b>35329</b>	662610 <b>16374</b>		
<b>Coarse</b>						
3/4	25,000	50	666233 <b>25013</b>	666233 <b>40021</b>	666233 <b>35410</b>	662610 <b>09515</b>
1	25,000	50	666233 <b>25015</b>	666233 <b>40023</b>	666233 <b>35537</b>	662610 <b>24310</b>
1-1/2	20,000	50	666233 <b>35411</b>	662610 <b>47579</b>	666233 <b>25017</b>	666233 <b>40026</b>
2	20,000	50	666233 <b>35414</b>		666233 <b>35413</b>	662610 <b>09183</b>
3	18,000	25	666233 <b>35417</b>	662610 <b>09194</b>	666233 <b>35416</b>	662610 <b>09186</b>
4	12,000	25	666233 <b>35419</b>	662610 <b>08822</b>		
<b>Medium</b>						
3/4	25,000	50	666233 <b>25020</b>	666233 <b>40032</b>	666233 <b>35420</b>	662544 <b>28059</b>
1	25,000	50	666233 <b>35422</b>	662544 <b>82331</b>	666233 <b>35421</b>	662544 <b>82327</b>
1-1/2	20,000	50	666233 <b>35424</b>	662544 <b>82332</b>	666233 <b>35423</b>	662544 <b>82328</b>
2	20,000	50	666233 <b>35427</b>	662610 <b>09190*</b>	666233 <b>35426</b>	662610 <b>09182</b>
3	18,000	25	666233 <b>35430</b>	662610 <b>17522</b>	666233 <b>35429</b>	662610 <b>09185</b>
4	12,000	25	666233 <b>35432</b>	662610 <b>08821</b>		662610 <b>55350</b>
<b>Fine</b>						
3/4	25,000	50	666233 <b>25026</b>	666233 <b>40058</b>	666233 <b>25025</b>	
1	25,000	50	666233 <b>25029</b>	666233 <b>40064</b>	666233 <b>25028</b>	666233 <b>40062</b>
1-1/2	20,000	50	666233 <b>25032</b>	666233 <b>40070</b>	666233 <b>25031</b>	666233 <b>40068</b>
2	20,000	50	666233 <b>25035</b>	666233 <b>40077</b>	666233 <b>25034</b>	666233 <b>40074</b>
3	18,000	25	666233 <b>25038</b>	666233 <b>40085</b>	666233 <b>25037</b>	666233 <b>40082</b>
4	12,000	25	666233 <b>25041</b>	666233 <b>40092</b>		
<b>Very Fine</b>						
3/4	25,000	50	666233 <b>25044</b>	666233 <b>40044</b>	666233 <b>25043</b>	666233 <b>40042</b>
1	25,000	50	666233 <b>25047</b>	662544 <b>82339</b>	666233 <b>25046</b>	662544 <b>82335</b>
1-1/2	20,000	50	666233 <b>25050</b>	662544 <b>82340</b>	666233 <b>25049</b>	662544 <b>82336</b>
2	20,000	50	666233 <b>35433</b>	662610 <b>09189*</b>	666233 <b>25052</b>	662544 <b>82337</b>
3	18,000	25	666233 <b>35437</b>	662610 <b>09192</b>	666233 <b>35436</b>	662610 <b>09184</b>
4	12,000	25		666233 <b>40053</b>		
<b>Super Fine</b>						
2	20,000	50		662610 <b>091459</b>		
3	18,000	25		662610 <b>091460</b>		

\* 25 per standard package.



Quick-Change Buffing/Polishing Discs

Best choice for light removal of paint or rust







**BUFFING/POLISHING DISCS**

- This aluminum oxide grain and resin bond combination produce a smooth cut rate and smear-free, uniform finish
- Non-woven nylon fibers are laminated to tough yet conformable nylon backing that resists tearing on burrs and sharp edges
- Designed for light removal of coatings oxidation or rust without affecting the base product

TIER:	<b>BEST</b>
TRADENAME:	<b>HIGH-STRENGTH</b>
ABRASIVE:	Aluminum Oxide
ATTACHMENT:	TR (Type III)



<b>BEST</b>	<b>BEST</b>	<b>BETTER</b>	<b>BETTER</b>
<b>HIGH-STRENGTH</b>	<b>HIGH-STRENGTH</b>	<b>BUFFING</b>	<b>BUFFING</b>
Aluminum Oxide	Aluminum Oxide	Aluminum Oxide	Aluminum Oxide
TR (Type III)	TS (Type II)	TR (Type III)	TS (Type II)

SIZE (D)	GRIT	MAX. RPM	STD. PKG.	PART #	STD. PKG.	PART #	PART #	PART #	PART #
1-1/2	M	20,000			100			088341 <b>66368</b>	088341 <b>66392</b>
	F	20,000			100			088341 <b>66369</b>	
2	C	18,000			50			088341 <b>61649</b>	088341 <b>66394</b>
	M	18,000	160	662610 <b>14792</b>	50	088341 <b>64064</b>	088341 <b>64244</b>	088341 <b>66303</b>	088341 <b>66395</b>
	F	18,000			50			088341 <b>66304</b>	088341 <b>66396</b>
	VF	18,000			50	088341 <b>63987</b>	088341 <b>64245</b>	088341 <b>66305</b>	088341 <b>66405</b>
3	C	12,000			25			088341 <b>61651</b>	088341 <b>66397</b>
	M	12,000	80	662610 <b>14793</b>	25	088341 <b>64065</b>	088341 <b>64252</b>	088341 <b>66308</b>	088341 <b>66398</b>
	F	12,000			25			088341 <b>66309</b>	088341 <b>66399</b>
	VF	12,000			25	088341 <b>63559</b>	088341 <b>64255</b>	088341 <b>66310</b>	088341 <b>66403</b>

### Quick-Change Back-up Pads

- Hard density pads are for aggressive cutting action
- Medium density pads are for all-purpose applications
- Soft density pads are used for contours and fine finishing work

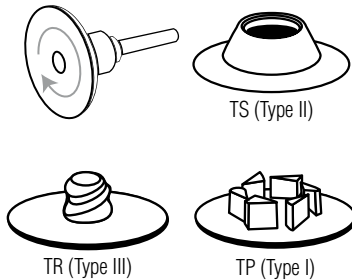

SIZE (DIAMETER)	DENSITY	MAX. RPM	STD. PKG.	TS (TYPE II)	TR (TYPE III)	TP (TYPE I)
<b>Quick-Change Back-up Pads</b>						
9/16		40,000	1	662610 <b>54014 NS</b>		662610 <b>54013 NS</b>
3/4	Medium	40,000	1	088341 <b>64206</b>	088341 <b>64038</b>	088341 <b>64001</b>
1	Medium	40,000	1	088341 <b>64651</b>	088341 <b>64037</b>	088341 <b>64002</b>
1-1/2	Hard	30,000	1	088341 <b>64622</b>		088341 <b>63996</b>
2	Medium	30,000	1	088341 <b>64146</b>	088341 <b>61174</b>	088341 <b>64003</b>
	Hard	30,000	1	088341 <b>64624</b>	088341 <b>64643</b>	088341 <b>63997</b>
	Medium	30,000	1	088341 <b>64198</b>	088341 <b>64922</b>	088341 <b>64004</b>
3	Soft	30,000	1	088341 <b>61625</b>	088341 <b>64641</b>	088341 <b>63949</b>
	Hard	20,000	1	088341 <b>61626</b>	088341 <b>64036</b>	088341 <b>63998</b>
	Medium	20,000	1	088341 <b>64113</b>	088341 <b>64949</b>	088341 <b>64005</b>
4	Soft	20,000	1	088341 <b>64626</b>	088341 <b>64644</b>	088341 <b>63948</b>
	Medium	15,000	1	088341 <b>64135</b>	088341 <b>64655</b>	
4	Medium	8,000	1		636425 <b>55106</b>	
<b>Vendible Quick-Change Back-up Pads</b>						
2	Medium	30,000	5	6662334 <b>1082</b>	6662334 <b>1083</b>	
3	Medium	20,000	5		6662334 <b>1085</b>	

VENDIBLE

All Quick-Change back-up pads have a 1/4" solid steel shank.

NS Non-stock. Contact your Norton representative for current order quantities and lead-times.

Vendible back-up pad Std. Pkg. Qty: 1 pad per pack; 5 packs per carton. Order in multiples of 5.

### Replacement Medium Density Rubber Pads for Quick-Change TP (Type I) Back-up Pads

- When the rubber pad has worn away, but the steel components of your quick-change back-up are still serviceable, order these replacement rubber pads.

SIZE (D)	MODEL #	STD. PKG.	PART #
<b>Quick-Change Replacement Rubber Back-up Pads</b>			
3/4	RR75	1	088341 <b>64008 NS</b>
1	RR10	1	088341 <b>64009 NS</b>
4	RR40	1	088341 <b>64013 NS</b>

NS Non-stock. Contact your Norton representative for current order quantities and lead-times.

### Replacement Assemblies and Shanks for Quick-Change Back-up Pad

- Assemblies replace all the steel components of a quick-change back-up pad. This shank replaces the screw-in 1/4" solid steel shank only.

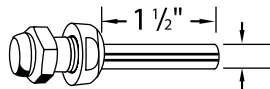

DESCRIPTION	STD. PKG.	PART #
<b>Replacement Mandrels and Nut Assembly</b>		
TP (Type I) Assembly RMN3 for 3 - 4	1	088341 <b>64016 NS</b>
TS (Type II) & TR (Type III) Replacement 1/4" Shank	1	088341 <b>64303</b>

NS Non-stock. Ask your Norton representative for current order quantities and lead-times

### Extension Mandrels and Assembly

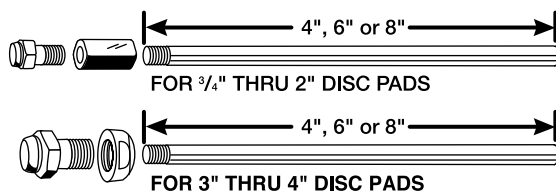

DIAMETER	MODEL #	LENGTH	STD. PKG.	PART #
<b>Extension Mandrels and Assembly - TP (Type I)</b>				
3/4 - 2	EMN-14	4"	1	088341 <b>64017 NS</b>
3/4 - 2	EMN-16	6"	1	088341 <b>64018 NS</b>
3/4 - 2	EMN-18	8"	1	088341 <b>64019 NS</b>
3 - 4	EMN-34	4"	1	088341 <b>64020 NS</b>
3 - 4	EMN-36	6"	1	088341 <b>64026 NS</b>
3 - 4	EMN-38	8"	1	088341 <b>64021 NS</b>

All extension mandrels are non-stock, Contact your Norton representative for current order quantities and lead-times.

### MNA-1 Pad Adapters

- Convert a TP (Type I) back-up pad 1/4" diameter solid shank to a threaded shank

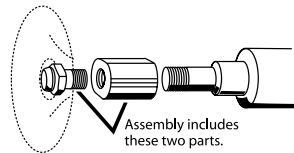

DISC DIAMETER	MODEL NO.	STD. PKG.	PART #
<b>MNA-1 Pad Adapters - TP (Type I)</b>			
3/4 - 2	MNA 1/4-20 THD.	1	088341 <b>61176 NS</b>
3/4 - 2	MNA 3/8-24	1	088341 <b>64055 NS</b>
3/4 - 2	MNA 5/8-11	1	088341 <b>63001 NS</b>
3 - 4	MNA 1/4-20	1	088341 <b>63002 NS</b>
3 - 4	MNA 3/8-24	1	088341 <b>64041 NS</b>
3 - 4	MNA 5/8-11	1	088341 <b>64028 NS</b>

All pad adapters are non-stock. Contact your Norton representative for current order quantities and lead-times.

### MNA-23 Pad Adapters

- For use on a right angle grinder: convert TS (Type II) and TR (Type III) back-up pad 1/4" diameter solid shanks to threaded shanks.
- The larger 5/8"-11 adapter (for 4-1/2" discs) is used alone to convert to a 5/8"-11 thread.
- The 3/8"-24 insert (for 4" discs) is screwed into the 5/8"-11 adapter to create a 3/8"-24 thread adapter.

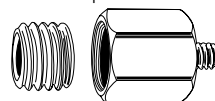

DISC DIAMETER	MODEL #	STD. PKG.	PART #
<b>MNA-23 Pad Adapters - TS (Type II) and TR (Type III)</b>			
3/4 - 4	MNA-23 3/8"-24 and 5/8"-11 THD.	1	088341 <b>62764 NS</b>

NS Non-stock. Ask your Norton representative for current order quantities and lead-times

### 1/4" Diameter Extension Mandrel

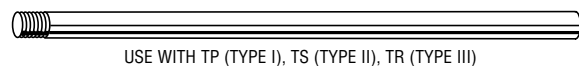

USE WITH TP (TYPE I), TS (TYPE II), TR (TYPE III)

MODEL NO.	LENGTH	STD. PKG.	PART #
<b>1/4" Diameter Extension Mandrel 1/4-20 Thread</b>			
EM-144	4"	1	088341 <b>54185</b>
EM-146	6"	1	088341 <b>54186</b>
EM-148	8"	1	088341 <b>54187</b>



Our new Norton pneumatic die grinder quickly and comfortably accomplishes many portable applications without changing machines – including jobs for abrasive specialties (cartridge and spiral rolls...), small diameter flap wheels, mounted points, and carbide burrs.

- Weight of tool:** 1.4 lbs.
- Compressed air:** 6.2 bar (90psi)
- Maximum permissible operating pressure:** 6.2 bar (90psi)
- Recommended operating pressure:** 6.2 bar (90psi)
- Horsepower:** 0.9HP
- Free speed:** 25,000 rpm
- Air consumption @90psi:** 85 l/min (3 CFM)
- Noise characteristic value in accordance with EN ISO 15744 (ISO 15744):**
  - A-weighted sound pressure level at workstation 87.3 dB
  - A-weighted sound power level 98.3 dB
  - Peak C-weighted instantaneous sound pressure level at workstation < 130 dB
  - Measurement uncertainty (Standard) 3 dB
- Vibration value according to EN ISO 28927-12:** 3.00 m/s<sup>2</sup>
- Measurement uncertainty (Standard):** 0.84 m/s<sup>2</sup>
- Recommended lubrications:** Air drill oil 20#
- Sanding tool specifications:** Pad Size 2" Collet Chuck 1/8" (3 mm) and 1/4" (6 mm)
- Applications and suitability:** Final surface finishing, chamfering, deburring of architectural millwork, sheet metal and surface prep, zinc casting, aluminum products, injection molds, etc.; general sanding and polishing.

Put the power right in the palm of your hand with our die grinder

**NEW**



## PNEUMATIC DIE GRINDER

- Comfortable during prolonged use thanks to vibration-limiting technology, ergonomic design, and streamlined non-slip grip
- Adaptable to the needs of each job with speed regulation and two collet inserts in 1/8" and 1/4"
- Compatible with many accessories including cartridge rolls, spiral rolls, square pads, cross pads, overlap slotted discs, flap wheels, mounted points and carbide burrs

DESCRIPTION	STD. PKG.	PART #
<b>Norton Pneumatic Die Grinder</b>		
Single Die Grinder with 1/8" and 1/4" collets	1	699573 <b>08000</b>
Die Grinder Kit*	1	699573 <b>08001</b>
Kit includes:		
1 die grinder with 1/8" and 1/4" collets		
100 – 3/8" x 1-1/2" x 1/8", 80 grit Metal R228 cartridge rolls (08834 <b>180232</b> )		
1- M9 cartridge roll mandrel (08834 <b>181209</b> )		
10 – 1" x 1" x 1/4" shank, 60 grit Blaze R920 flap wheels (66261 <b>151170</b> )		
5 – 1" x 1" W220, 1/4" x 1-1/2" spindle Gemini 38A60-P mounted points (614636 <b>24566</b> )		
1 – 1/2" x 1" SF5 Double-Cut carbide burr (699573 <b>08021</b> )		



## YouTube

Learn more about how to safely and effectively use a die grinder on our Youtube page <https://nortonsga.us/44yj2> or visit <http://nortonsga.us/diegrinder>



Cartridge rolls are strips of abrasive cloth rolled and glued to form a solid shape that is designed to break down during use and reveal the next layer of abrasive. A valuable abrasive tool for reaching into corners, where larger diameter tools cannot work

- Applications:** Used on inside surfaces and inside corners where other abrasive shapes cannot reach. Typically these are used on high-speed air grinders and are always mounted on a mandrel. Ideal for flash removal, polishing or removing machine tool marks, and edge breaking.
- Stock Shapes:** Cartridge rolls, half-glued
- Grit Range:** 36 - 320
- Abrasive Grain:** Ceramic Alumina, Aluminum Oxide
- Backing:** X-weight cotton, X-weight poly-cotton
- Construction:** All cartridge roll part numbers shown are resin bond, half-glued. Quarter and full glue are also available for quotation as made-to-order products.
- Maximum RPM:** 1/8" to 1/2" – 23,000  
5/8" to 1" – 18,000  
1" to 1-1/2" – 15,000
- Machine Used:**  DIE GRINDER

### Application/Grit Recommendation Guide

COARSER (GRINDING) ←									→ FINER (FINISHING)	
36	40	50	60	80	120	180	240	320		
Blending Out Heavy Machine Marks										
Removing Heavy Burrs										
Applying Heavy Scratch Pattern										
Removing Flash/Parting Lines										
Removing Rust/Scale/Pit Marks										
		Preparing Metal for Painting								
		Blending Out Medium Machine Marks								
				Blending Metal Surfaces						
				Applying Light Scratch Pattern						
						Fine Blending and Cleaning				
							Metal Finishing and Polishing			

**Best choice for hard-to-grind materials including super alloys (cobalt, inconel, and titanium) and stainless steel**



## BLAZE R920 CERAMIC ALUMINA

- Premium ceramic alumina abrasive grain provides greatest productivity with significantly faster cut rates; resists wear resulting in 50% – 300% longer life; supersized for cool cutting
- X-weight cotton cloth provides extended durability, conformability, and superior wear resistance; strong resin bond system provides good grain retention and life
- Constructed of rolled and half-glued abrasive strips that break down to expose next layer of abrasive

**Better choice for accessing tight areas and where long life & fast cut are required**



**NEW**

## PINK R928 CERAMIC ALUMINA

- Excellent option for reaching into corners and small areas, ceramic grain provides better performance than aluminum oxide or zirconia alumina alternatives
- Improved resin bond system provides longer life; supersized for cool cutting
- Versatile X-weight poly cotton backing for flexibility and life

**Good starting specification for flash removal, polishing, or removing machine tool marks and edge breaking on all types of metal**



## R228 ALUMINUM OXIDE

- Quality aluminum oxide abrasive delivers long life
- X-weight cotton cloth provides extended durability, conformability, and superior wear resistance; strong resin bond system provides good grain retention and life
- Constructed of rolled and half-glued abrasive strips that break down to expose next layer of abrasive



TIER:	BEST	BETTER
TRADENAME:	<b>BLAZE R920</b>	<b>PINK R928</b>
ABRASIVE:	Ceramic Alumina	Ceramic Alumina
OTHER:	Supersize	Supersize

SIZE (D x L x H)	GRIT	STD. PKG.	PART #	PART #
1/4 x 1-1/2 x 1/8	60	100	662611 <b>94384</b>	699573 <b>39765</b>
Use M-9 Mandrel	80	100	662611 <b>94394</b>	699573 <b>39766</b>
	120	100	662611 <b>94397</b>	699573 <b>39767</b>
3/8 x 1-1/2 x 1/8	60	100	662611 <b>94392</b>	699573 <b>39768</b>
Use M-9 Mandrel	80	100	662611 <b>94395</b>	699573 <b>39769</b>
	120	100	662611 <b>94398</b>	699573 <b>39770</b>
1/2 x 1-1/2 x 1/8	60	100	662611 <b>94393</b>	699573 <b>39771</b>
Use M-9 Mandrel	80	100	662611 <b>94396</b>	699573 <b>39772</b>
	120	100	662611 <b>94399</b>	699573 <b>39774</b>



TIER:	GOOD
TRADENAME:	<b>R228</b>
ABRASIVE:	Aluminum Oxide

SIZE (D x L x H)	GRIT	STD. PKG.	PART #
3/16 x 3/4 x 3/32	80	100	088341 <b>80005</b>
3/16 x 1 x 3/32	60	100	088341 <b>80023</b>
Use M-2E Mandrel	80	100	088341 <b>80024</b>
	100	100	088341 <b>80025</b>
	120	100	088341 <b>80026</b>
	150	100	088341 <b>80027</b>
	180	100	088341 <b>80028</b>
	240	100	088341 <b>80030</b>
1/4 x 3/4 x 1/8	60	100	088341 <b>80042</b>
Use M-3 or M-7 Mandrel	80	100	088341 <b>80043</b>
1/4 x 1 x 1/8	50	100	088341 <b>80060</b>
Use M-4 or M-8 Mandrel	60	100	088341 <b>80061</b>
	80	100	088341 <b>80062</b>
	100	100	088341 <b>80063</b>
	120	100	088341 <b>80064</b>
	150	100	088341 <b>80065</b>
	180	100	088341 <b>80066</b>
	320	100	088341 <b>80070</b>
1/4 x 1-1/2 x 1/8	50	100	088341 <b>80079</b>
Use M-9 Mandrel	60	100	088341 <b>80080</b>
	80	100	088341 <b>80081</b>
	100	100	088341 <b>80082</b>
	120	100	088341 <b>80083</b>
	150	100	088341 <b>80084</b>
	180	100	088341 <b>80085</b>
	320	100	088341 <b>80089</b>
1/4 x 2 x 1/8	80	100	088341 <b>80100</b>
Use M-10 Mandrel	120	100	088341 <b>80102</b>
5/16 x 1 x 1/8	80	100	088341 <b>80138</b>
Use M-4 or M-8 Mandrel	120	100	088341 <b>80140</b>
5/16 x 1-1/2 x 1/8	80	100	088341 <b>80157</b>
Use M-9 Mandrel			

TIER:	GOOD
TRADENAME:	<b>R228</b>
ABRASIVE:	Aluminum Oxide

SIZE (D x L x H)	GRIT	STD. PKG.	PART #
3/8 x 3/4 x 1/8	120	100	088341 <b>80197</b>
Use M-7 Mandrel			
3/8 x 1 x 1/8	60	100	088341 <b>80213</b>
Use M-8 Mandrel	80	100	088341 <b>80214</b>
	100	100	088341 <b>80215</b>
	120	100	088341 <b>80216</b>
	150	100	088341 <b>80217</b>
	180	100	088341 <b>80218</b>
	240	100	088341 <b>80220</b>
3/8 x 1-1/2 x 1/8	36	100	088341 <b>80228</b>
Use M-9 Mandrel	40	100	088341 <b>80229</b>
	50	100	088341 <b>80230</b>
	60	100	088341 <b>80231</b>
	80	100	088341 <b>80232</b>
	100	100	088341 <b>80233</b>
	120	100	088341 <b>80234</b>
	180	100	088341 <b>80236</b>
	240	100	088341 <b>80238</b>
	320	100	088341 <b>80240</b>
3/8 x 2 x 1/8	60	100	088341 <b>80250</b>
Use M-10 Mandrel	80	100	088341 <b>80251</b>
	120	100	088341 <b>80253</b>
1/2 x 3/4 x 1/8	80	100	088341 <b>80270</b>
Use M-7 Mandrel			
1/2 x 1 x 1/8	50	100	088341 <b>80287</b>
Use M-8 Mandrel	60	100	088341 <b>80288</b>
	80	100	088341 <b>80289</b>
	100	100	088341 <b>80290</b>
	120	100	088341 <b>80291</b>
	150	100	088341 <b>80292</b>
	180	100	088341 <b>80293</b>
	240	100	088341 <b>80295</b>

Some part numbers are non-stock; contact your Norton representative for status, order quantities and lead-times.  
Continued

Continued

Refer to the back of this section for mandrels.



TIER: **GOOD**  
TRADENAME: **R228**  
ABRASIVE: Aluminum Oxide

SIZE (D x L x H)	GRIT	STD. PKG.	PART #
1/2 x 1-1/2 x 1/8 Use M-9 Mandrel	36	100	088341 <b>80304</b>
	40	100	088341 <b>80305</b>
	50	100	088341 <b>80306</b>
	60	100	088341 <b>80307</b>
	80	100	088341 <b>80308</b>
	100	100	088341 <b>80309</b>
	120	100	088341 <b>80310</b>
	150	100	088341 <b>80311</b>
	180	100	088341 <b>80312</b>
	240	100	088341 <b>80314</b>
1/2 x 2 x 1/8 Use M-10 Mandrel	320	100	088341 <b>80316</b>
	60	100	088341 <b>80326</b>
	80	100	088341 <b>80327</b>
1/2 x 2 x 3/16 Use M-17 Mandrel	120	100	088341 <b>80329</b>
	60	100	088341 <b>80350</b>
	80	100	088341 <b>80653</b>
1/2 x 2 x 1/4 Use M-22 Mandrel	120	100	088341 <b>80338</b>
	80	100	088341 <b>80351</b>
5/8 x 1 x 3/16 Use M-15 Mandrel	80	100	088341 <b>80364</b>
5/8 x 1-1/2 x 1/8 Use M-9 Mandrel	60	100	088341 <b>80275</b>
	80	100	088341 <b>80789</b>
	120	100	088341 <b>80394</b>
5/8 x 1-1/2 x 3/16 Use M-16 Mandrel	60	100	088341 <b>80382</b>
	80	100	088341 <b>80383</b>
5/8 x 2 x 1/8 Use M-10 Mandrel	60	100	088341 <b>82505</b>
	80	100	088341 <b>81080</b>
5/8 x 2 x 3/16 Use M-10 Mandrel	50	100	088341 <b>80400</b>
	60	100	088341 <b>80401</b>
	80	100	088341 <b>80402</b>
3/4 x 1 x 1/8 Use M-8 Mandrel	80	100	088341 <b>80469</b>
	120	100	088341 <b>81543</b>
3/4 x 1 x 3/16 Use M-15 Mandrel	80	100	088341 <b>80459</b>
	120	100	088341 <b>80461</b>

Some part numbers are non-stock; contact your Norton representative for status, order quantities and lead-times.  
Continued



TIER: **GOOD**  
TRADENAME: **R228**  
ABRASIVE: Aluminum Oxide

SIZE (D x L x H)	GRIT	STD. PKG.	PART #
3/4 x 1-1/2 x 1/8 Use M-9 Mandrel	60	100	088341 <b>80490</b>
	80	100	088341 <b>80527</b>
	120	100	088341 <b>80487</b>
3/4 x 1-1/2 x 3/16 Use M-16 Mandrel	36	100	088341 <b>80474</b>
	50	100	088341 <b>80476</b>
	60	100	088341 <b>80477</b>
	80	100	088341 <b>80478</b>
	120	100	088341 <b>80480</b>
3/4 x 1-1/2 x 1/4 100/box 400/case Use M-21 Mandrel	180	100	088341 <b>80482</b>
	36	100	088341 <b>80907</b>
	60	100	088341 <b>80489</b>
	80	100	088341 <b>80358</b>
1/2 x 2 x 1/8 Use M-10 Mandrel	120	100	088341 <b>80488</b>
	150	100	088341 <b>82807</b>
	60	100	088341 <b>80791</b>
	3/4 x 2 x 3/16 Use M-17 Mandrel	40	100
3/4 x 2 x 1/4 Use M-22 Mandrel	60	100	088341 <b>80496</b>
	80	100	088341 <b>80497</b>
	100	100	088341 <b>80498</b>
	120	100	088341 <b>80499</b>
3/4 x 2 x 1/4 Use M-22 Mandrel	60	100	088341 <b>80506</b>
	80	100	088341 <b>81297</b>
	100	100	088341 <b>80509</b>
1 x 1-1/2 x 1/8 Use M-9 Mandrel	120	100	088341 <b>80507</b>
	80	100	088341 <b>80584</b>
	1 x 1-1/2 x 1/4 Use M-21 Mandrel	36	100
1 x 2 x 3/16 Use M-17 Mandrel	60	100	088341 <b>80587</b>
	80	100	088341 <b>80583</b>
	100	100	088341 <b>80591</b>
1 x 2 x 1/4 Use M-22 Mandrel	60	100	088341 <b>80592</b>
	80	100	088341 <b>80603</b>
1 x 2 x 1/4 Use M-22 Mandrel	60	100	088341 <b>80603</b>
	80	100	088341 <b>80606</b>

Refer to the back of this section for mandrels.



Spiral rolls are strips of abrasive cloth rolled and glued to form a solid shape that is designed to break down during use and reveal the next layer of abrasive.

- Applications:** Used on inside surfaces and inside corners where other abrasive shapes cannot reach. Typically these are used on high-speed air grinders and are always mounted on a mandrel. Ideal for flash removal, polishing, or removing machine tool marks, and edge breaking.
- Shapes:** Full taper (all stock part numbers), half taper, and sidewall taper
- Grit Range:** 36 - 240
- Abrasive Grain:** Ceramic Alumina, Aluminum Oxide
- Backing:** X-weight cotton, X-weight poly cotton
- Construction:** All spiral roll part numbers shown are full tapered, resin bond, half glued. Half-tapered and sidewall-tapered are available for quotation as made-to-order products. Quarter and full glue are also available for quotation as made-to-order products
- Maximum RPM:** 1/8" to 1/2" – 23,000  
5/8" to 1" – 18,000  
1" to 1-1/2" – 15,000
- Machine Used:**  DIE GRINDER

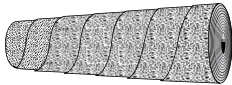

**Full Taper**

- Especially useful for grinding/polishing of channels, fillets and radii, and deburring small holes
- Full taper used when the area to be finished is hard to reach with a full cartridge roll
- The tapered roll conforms to smaller areas
- Fits into irregular concaves, contours, channels

*All part numbers shown are full tapered*

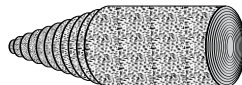

**Half Taper**

- Used when the area to be finished is not narrow but a beginning point on the roll is needed
- The portion of the roll that is not tapered is then used to finish off the sides

*Available for quotation as made-to-order products*

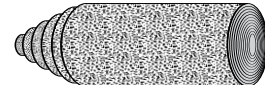

**Sidewall Taper**

- The portion of the roll that is tapered guides the roll down to the area to be finished
- The sidewall then finishes off the sides

*Available for quotation as made-to-order products*

**Application/Grit Recommendation Guide**

COARSER (GRINDING)					FINER (FINISHING)			
36	40	50	60	80	120	180	240	320
Blending Out Heavy Machine Marks								
Removing Heavy Burrs								
Applying Heavy Scratch Pattern								
Removing Flash/Parting Lines								
Removing Rust/Scale/Pit Marks								
		Preparing Metal for Painting						
		Blending Out Medium Machine Marks						
				Blending Metal Surfaces				
				Applying Light Scratch Pattern				
						Fine Blending and Cleaning		
							Metal Finishing and Polishing	



**Best choice for hard-to-grind materials including super alloys (cobalt, inconel, and titanium) and stainless steel**



## BLAZE R920 CERAMIC ALUMINA

- See significantly faster, cooler, burn-free results on the toughest jobs from the premium, sharp, longest-lasting P-graded ceramic abrasive grains and advanced grinding aid lubricant; supersized for cool cutting
- X-weight cotton cloth provides extended durability, conformability, and superior wear resistance; strong resin bond system provides good grain retention and life
- Full taper construction consisting of rolled and half-glued abrasive strips that break down to expose next layer of abrasive

**NEW**

**Better choice for accessing tight areas and where long life and fast cut are required**



## PINK R928 CERAMIC ALUMINA

- Excellent option for reaching into corners and small areas, ceramic grain provides better performance than aluminum oxide or zirconia alumina alternatives
- Improved resin bond system provides longer life; supersized for fast cutting
- Versatile X-weight poly cotton backing for flexibility and life

**Good choice for cooler grinding/polishing of channels, fillets and radii, and deburring small holes at a low initial price**



## R228 ALUMINUM OXIDE

- Quality aluminum oxide abrasive delivers long life
- X-weight cotton cloth provides extended durability, conformability, and superior wear resistance; strong resin bond system provides good grain retention and life
- Full taper construction consisting of rolled and half-glued abrasive strips that break down to expose next layer of abrasive





TIER:	BEST	BETTER	GOOD
TRADENAME:	<b>BLAZE R920</b>	<b>PINK R928</b>	<b>R228</b>
ABRASIVE:	Ceramic Alumina	Ceramic Alumina	Aluminum Oxide
OTHER:	Supersize	Supersize	

SIZE (D x L x H)	GRIT	STD. PKG.	PART #	PART #	PART #
3/8 x 1 x 1/8 Use M-8 Mandrel	60	100			088341 <b>81714</b>
	80	100			088341 <b>81715</b>
	120	100			088341 <b>81717</b>
3/8 x 1-1/2 x 1/8 Use M-9 Mandrel	60	100	662611 <b>94481</b>	699573 <b>39775</b>	088341 <b>81724</b>
	80	100	662611 <b>94490</b>	699573 <b>39785</b>	088341 <b>81708</b>
	120	100	662611 <b>94491</b>	699573 <b>39787</b>	088341 <b>81727</b>
	180	100			088341 <b>81709</b>
1/2 x 1 x 1/8 Use M-8 Mandrel	60	100			088341 <b>81734</b>
	80	100			088341 <b>81735</b>
	120	100			088341 <b>81737</b>
1/2 x 1-1/2 x 1/8 Use M-9 Mandrel	36	100			088341 <b>81230</b>
	50	100			088341 <b>81743</b>
	60	100	662611 <b>94484</b>	699573 <b>39790</b>	088341 <b>81744</b>
	80	100	662611 <b>94492</b>	699573 <b>39791</b>	088341 <b>81745</b>
	100	100			088341 <b>81746</b>
	120	100	662611 <b>94495</b>	699573 <b>39792</b>	088341 <b>81747</b>
	180	100			088341 <b>81749</b>
1/2 x 2 x 1/8 Use M-10 Mandrel	240	100			088341 <b>81750</b>
	60	100			088341 <b>81754</b>
	80	100			088341 <b>81755</b>
5/8 x 1-1/2 x 1/8 Use M-9 Mandrel	120	100			088341 <b>81757</b>
	100	100			088341 <b>81776</b>
	120	100			088341 <b>81777</b>
5/8 x 1-1/2 x 3/16 Use M-16 Mandrel	80	100			088341 <b>81444</b>
3/4 x 1-1/2 x 1/8 Use M-9 Mandrel	60	100			088341 <b>81286</b>
	80	100			088341 <b>80886</b>
3/4 x 1-1/2 x 3/16 Use M-16 Mandrel	60	100			088341 <b>81808</b>
	80	100			088341 <b>81809</b>
	120	100			088341 <b>81811</b>
3/4 x 2 x 3/16 Use M-17 Mandrel	60	100			088341 <b>81820</b>
1 x 1-1/2 x 1/8 Use M-9 Mandrel	60	100		699573 <b>39790</b>	088341 <b>81240</b>
1 x 2 x 3/16 Use M-17 Mandrel	36	100			088341 <b>81875</b>
	60	100			088341 <b>81878</b>
	80	100			088341 <b>81879</b>

Some part numbers are non-stock; contact your Norton representative for status, order quantities and lead-times.

Refer to the back of this section for mandrels.



Square pads, cross pads and overlap slotted discs are all used on high-speed pneumatic tools for deburring, blending, cleaning, and polishing applications. All of these abrasive specialties are designed for applications in small, tight, hard-to-access locations on parts that are being finished.

- Benefits:** Variety of shapes and sizes to fit application and part geometry  
Shapes provide flexibility for the application, while eliminating aggressiveness of the sanding action  
Cross pads allow visibility of the surface while sanding, to ensure correct amount of material is removed
- Grit Range:** 50 – 180
- Abrasive Grain:** Ceramic Alumina, Aluminum Oxide
- Backing:** X-weight cotton, X-weight poly-cotton
- Construction:** Standard quick-change eyelet for easy mounting and removal on quick-change mandrel minimizes downtime; Mandrel use increases range and versatility
- Maximum RPM:** 1" Diameter – 25,000      3" Diameter – 12,000 to 14,000  
1-1/2" to 2" Diameter – 18,000 to 23,000      4" Diameter – 8,000 to 12,000  
2-1/2" Diameter – 14,000 to 18,000      5" to 6" Diameter – 5,500 to 7,500
- Machine Used:**  DIE GRINDER

**Application/Grit Recommendation Guide**

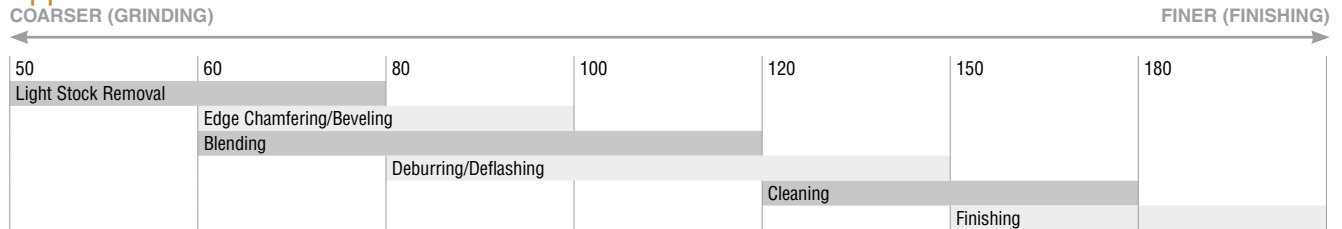

Best choice for hard-to-grind materials including super alloys (cobalt, inconel, and titanium) and stainless steel



**BLAZE R920 CERAMIC ALUMINA**

- See significantly faster, cooler, burn-free results on the toughest jobs from the sharp, longest-lasting P-graded ceramic abrasive grains and advanced supersize grinding aid for cool cutting
- X-weight cotton cloth provides extended durability, conformability, and superior wear resistance; strong resin bond system provides good grain retention and life
- Corners wear down consistently, exposing fresh abrasive; as these become round, they become less aggressive and run even smoother, with less stock removal – to retain workpiece shape

Better choice for accessing tight areas and where long life & fast cut are required



**PINK R928 CERAMIC ALUMINA**

- Excellent option for reaching into corners and small areas, ceramic grain provides better performance than aluminum oxide and zirconia alternatives
- Improved resin bond system provides longer life; supersized for cool cutting
- Versatile X-weight poly cotton backing for flexibility and life

Good for most ID deburring and polishing applications



**R228 ALUMINUM OXIDE**

- Versatile, quality aluminum oxide abrasive grain ensures good cut rate
- X-weight cotton cloth provides extended durability, conformability, and superior wear resistance; strong resin bond system provides good grain retention and life
- Corners wear down consistently, exposing fresh abrasive; as these become round, they become less aggressive and run even smoother, with less stock removal – to retain workpiece shape

Square & Cross Pads, Overlap Slotted Discs

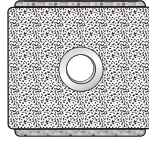

Square Pads

- Corners wear down consistently exposing fresh abrasive; the pad becomes round for less aggressive stock removal
- Grind almost as fast as hard wheels, but are much smoother and easier to control
- For quick blending of channels, fillets, corners, or spotting flat surfaces



		TIER: <b>BEST</b>		BETTE4R		GOOD	
		TRADENAME: <b>BLAZE R920</b>		<b>PINK R928</b>		<b>R228</b>	
		ABRASIVE: Ceramic Alumina		Ceramic Alumina		Aluminum Oxide	
		OTHER: Supersize		Supersize			
SIZE (L x W x T)	EYELET	GRIT	STD. PKG.	PART #	PART #	PART #	
1 x 1 x 6 ply	8-32	80	100			088341	<b>84826</b>
1 x 1 x 8 ply		80	100			088341	<b>84124</b>
1-1/2 x 1-1/2 x 1/2	1/4-20	60	100			088341	<b>84463</b>
		80	100			088341	<b>84125</b>
2 x 2 x 1/2	1/4-20	60	100	662611	<b>94520</b>	699573	<b>40138</b>
		80	100	662611	<b>94552</b>	699573	<b>40139</b>
		120	100	662611	<b>94554</b>	699573	<b>40141</b>
2 x 2 x 3/4	1/4-20	80	100			088341	<b>84394</b>
3 x 3 x 1/4	1/4-20	60	100	662611	<b>94531</b>	699573	<b>40142</b>
		80	100	662611	<b>94555</b>	699573	<b>40143</b>
		120	100	662611	<b>94556</b>	699573	<b>40144</b>
3 x 3 x 1/2	1/4-20	50	100			088341	<b>82152</b>
		60	100	662611	<b>94528</b>	699573	<b>40146</b>
		80	100	662611	<b>94557</b>	699573	<b>40147</b>
		120	100	662611	<b>94558</b>		<b>84336</b>

Some part numbers are non-stock; contact your Norton representative for status, order quantities and lead-times.

Refer to the back of this section for mandrels.

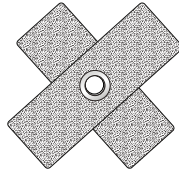

### Cross Pads

- The shape of cross pads enables you to see through to the contact area, and provides greater flexibility than square pads to conform to variable internal diameters
- Used for close-tolerance polishing of small radii and channels, deburring, and finishing of bell-mouth configurations
- All pads are furnished with standard quick-change eyelet, as listed
- Plain hole sizes must be specified and are available for quotation as made-to-order products



TIER:	BEST	BETTER	GOOD
TRADENAME:	<b>BLAZE R920</b>	<b>PINK R928</b>	<b>R228</b>
ABRASIVE:	Ceramic Alumina	Ceramic Alumina	Aluminum Oxide
OTHER:	Supersize	Supersize	

SIZE (L x W x T)	PLY	EYELET	GRIT	STD. PKG.	PART #	PART #	PART #
3/4 x 3/4 x 3/8	8	3-48	80	100			088341 <b>85578</b>
1 x 1 x 3/8	8	3-48	60	100			088341 <b>84943</b>
			80	100			088341 <b>85519</b>
			100	100			088341 <b>84195</b>
			120	100			088341 <b>85164</b>
1-1/2 x 1-1/2 x 1/2	8	8-32	60	100	662611 <b>94496</b>	699573 <b>39793</b>	088341 <b>84258</b>
			80	100	662611 <b>94508</b>	699573 <b>39794</b>	088341 <b>84465</b>
			100	100			088341 <b>82196</b>
			120	100	662611 <b>94511</b>	699573 <b>39804</b>	088341 <b>82148</b>
2 x 2 x 1/2	8	8-32	60	100			088341 <b>82156</b>
			80	100			088341 <b>82157</b>
			120	100			088341 <b>82132</b>
2 x 2 x 3/4	8	8-32	60	100	662611 <b>94502</b>	699573 <b>39806</b>	088341 <b>84128</b>
			80	100	662611 <b>94513</b>	699573 <b>40133</b>	088341 <b>84194</b>
			120	100	662611 <b>94516</b>	699573 <b>40134</b>	
2-1/4 x 2-1/4 x 1/2	8	8-32	80	100			088341 <b>84402</b>
2-1/2 x 2-1/2 x 3/4	8	8-32	80	100			088341 <b>84206</b>
3 x 3 x 1	8	1/4-20	60	100	662611 <b>94504</b>		088341 <b>82135</b>
			80	100	662611 <b>94549</b>		088341 <b>84119</b>
			120	100	662611 <b>94551</b>		088341 <b>84116</b>
3 x 3 x 1	8	1/4-20	60	100		699573 <b>40135</b>	
			80	100		699573 <b>40136*</b>	088341 <b>82140</b>
			120	100		699573 <b>40137</b>	
3 x 3 x 1-1/2	10	1/4-20	80	100			088341 <b>82184</b>
4 x 4 x 1	8	1/4-20	60	100			088341 <b>84142</b>
			80	100			088341 <b>84135</b>
			120	100			088341 <b>84377</b>
4 x 4 x 1-1/2	8	1/4-20	80	100			088341 <b>84129</b>

\* Pink R928 3 x 3 x 1 are 8 ply.

Ceramic Alumina and Alumina Oxide cross pads are also available upon request as made-to-order products.

Some part numbers are non-stock; contact your Norton representative for status, order quantities and lead-times.

Refer to the back of this section for mandrels.



### Overlap Slotted Discs

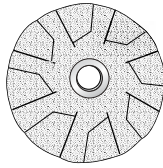

#### Overlap Slotted Discs

- Used for deburring and polishing radii, holes and cylinder walls
- Our "2 to a set" configuration cuts on the inward motion only
- The "4 to a set" configuration, assembled back to back, cuts on both the inward and outward motions
- All discs are furnished with standard quick-change eyelet
- Plain hole sizes must be specified and are available for quotation as made-to-order products



TIER:	BEST	GOOD
TRADENAME:	<b>BLAZE R920</b>	<b>R228</b>
ABRASIVE:	Ceramic Alumina	Aluminum Oxide
OTHER:	Supersize, 2 Per Set	2 Per Set

DIA.	EYELET	GRIT	STD. PKG.	PART #	PART #
1	8-32	60	100		088341 <b>84346</b>
		80	100		088341 <b>84019</b>
		100	100		088341 <b>84224</b>
		120	100		088341 <b>84151</b>
1-1/4	8-32	60	100		088341 <b>84270</b>
		80	100		088341 <b>84065</b>
		100	100		088341 <b>84291</b>
		120	100		088341 <b>84084</b>
1-1/2	8-32	60	100	662611 <b>95051</b>	088341 <b>84066</b>
		80	100	662611 <b>95368</b>	088341 <b>84079</b>
		100	100		088341 <b>84279</b>
		120	100	662611 <b>95367</b>	088341 <b>86035</b>
1-3/4	8-32	60	100		088341 <b>84655</b>
		80	100		088341 <b>84042</b>
2	8-32	60	100	662611 <b>95054</b>	
		80	100	662611 <b>95055</b>	088341 <b>84076</b>
		100	100		088341 <b>84145</b>
		120	100	662611 <b>95056</b>	088341 <b>84055</b>
2-1/2	8-32	80	100		088341 <b>84444</b>
3	1/4-20	60	100	662611 <b>95057</b>	088341 <b>84041</b>
		80	100	662611 <b>95058</b>	088341 <b>84077</b>
		100	100		088341 <b>84082</b>
		120	100		088341 <b>84344</b>
4	1/4-20	60	100		088341 <b>84000</b>
		120	100		088341 <b>85155</b>
4-1/2	1/4-20	100	100		088341 <b>84431</b>

All overlap slotted discs are available (made-to-order) reinforced with a fiber washer

Ceramic Alumina and Alumina Oxide overlap slotted discs are also available upon request as made-to-order products.

Some part numbers are non-stock; contact your Norton representative for status, order quantities and lead-times.

### Quick-Change Mandrels for Overlap Slotted Discs, Square and Cross Pads

CROSS PAD SIZE DIA.	SQUARE PAD SIZE DIA.	OVERALL LENGTH	MODEL NO.	THD. SIZE	PART #
1/4, 3/8, and 1/2 wide		2-1/2	MM48-4	3-48	088341 <b>83162</b>
3/4, 1 wide	Up thru 1-1/2 sq. x 1/2 thick 2 sq. x 1/4 or 3/8 thick	3	MM32-4	8-32	088341 <b>83163</b>
		4	MM-32-4-4	8-32	088341 <b>21680</b>
		6	MM-32-4-6	8-32	088341 <b>21681</b>
All pads 2-1/2 x 1-1/2 and larger	2 sq. x 1/4 or 1/2 thick and larger	3	MM20-4	1/4-20	088341 <b>83164</b>

For overlap slotted discs, choose a mandrel with the same thread size as the disc

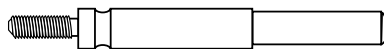

QUICK-CHANGE MANDREL



EXTENDED MANDREL



Best product for blending and polishing contours when smooth running is a primary concern. Used for finishing hard-to-reach areas, removing parting lines, imperfections, and burrs on all surfaces.

**Benefits:**

Spiral construction avoids shadow marks and provides smooth, chatter-free cutting action. Achieves close tolerances when finishing curved, contoured, and hard-to-reach areas. Fast cutting and removes toughest metal. Bands are easily removed and replaced.

**Grit Range:**

24 - 320

**Abrasive Grain:**

Ceramic Alumina, Aluminum Oxide

**Backing:**

X-weight cotton

**Other:**

Use with rubber expanding drum

**Machine Used:**



DIE GRINDER

**Application/Grit Recommendation Guide**

← COARSER (GRINDING)					FINER (FINISHING) →				
24	36	40	50	60	80	120	180	240	320
Heavy Stock Removal									
Blending Out Heavy Machine Marks									
Removing Heavy Burrs									
Applying Heavy Scratch Pattern									
Removing Flash/Parting Lines									
Removing Rust/Scale/Pit Marks									
			Preparing Metal for Painting						
			Blending Out Medium Machine Marks						
					Blending Metal Surfaces				
					Applying Light Scratch Pattern				
							Fine Blending and Cleaning		
								Metal Finishing and Polishing	

**Best choice for hard-to-grind materials including super alloys (cobalt, inconel, and titanium) and stainless steel**



**BLAZE R920 CERAMIC ALUMINA**

- See significantly faster, cooler, burn-free results on the toughest jobs from the next-generation of sharp, longest-lasting P-graded ceramic abrasive grains and advanced grinding aid lubricant
- Advanced, full resin bond system designed to promote exceptional grain retention for additional product life
- X-weight cotton backing and spiral construction avoid shadow marks and provide smooth, chatter-free cutting action

**Good starting specification for all types of metal**



**R228 ALUMINUM OXIDE**

- Tough and durable quality aluminum oxide abrasive removes tough metal
- X-weight cotton backing and spiral construction avoid shadow marks and provide smooth, chatter-free cutting action
- Achieves close tolerances on curved, contoured, and hard-to-reach areas



TIER: **BEST**  
 TRADENAME: **BLAZE R920**  
 ABRASIVE: Ceramic Alumina  
 OTHER: Supersize

SIZE (D x W)	GRIT	STD. PKG.	PART #
1/2 x 1	40	100	662611 <b>46012</b>
	60	100	662611 <b>46013</b>
	80	100	662611 <b>46014</b>
	120	100	662611 <b>46015</b>
3/4 x 1	40	100	662611 <b>46016</b>
	60	100	662611 <b>46017</b>
	80	100	662611 <b>46018</b>
	120	100	662611 <b>46019</b>
1 x 1	40	100	662611 <b>46020</b>
	60	100	662611 <b>46021</b>
	80	100	662611 <b>46022</b>
	120	100	662611 <b>46023</b>
1-1/2 x 1-1/2	40	100	662611 <b>46024</b>
	60	100	662611 <b>46025</b>
	80	100	662611 <b>46026</b>
	120	100	662611 <b>46027</b>
2 x 2	40	100	662611 <b>46028</b>
	60	100	662611 <b>46029</b>
	80	100	662611 <b>46030</b>
	120	100	662611 <b>46031</b>
3 x 3	40	50	662611 <b>46032</b>
	60	50	662611 <b>46033</b>
	80	50	662611 <b>46034</b>
	120	50	662611 <b>46035</b>



TIER: **GOOD**  
 TRADENAME: **R228**  
 ABRASIVE: Aluminum Oxide

SIZE (D x W)	GRIT	STOCK PKG. QTY.	NON-STOCK MOQ	PART #
3/8 x 1	80	100/box	300	088341 <b>96645</b>
1/2 x 1/2	50	100/box	300	088341 <b>96228</b>
	80	100/box	300	088341 <b>96179</b>
	100	100/box	300	088341 <b>96189</b>
	120	100/box	300	088341 <b>96069</b>
1/2 x 1	180	100/box	300	088341 <b>96209</b>
	36	100/box	300	088341 <b>96591</b>
	40	100/box	300	088341 <b>96174</b>
	60	100/box	300	088341 <b>96212</b>
1/2 x 2	80	100/box	300	088341 <b>96215</b>
	120	100/box	300	088341 <b>96210</b>
	50	100/box	200	088341 <b>96548</b>
	80	100/box	200	088341 <b>96669</b>
3/4 x 3/4	60	100/box	300	088341 <b>96168</b>
	80	100/box	300	088341 <b>96161</b>
3/4 x 1	36	100/box	300	088341 <b>96261</b>
	40	100/box	300	088341 <b>96517</b>
	50	100/box	300	088341 <b>96515</b>
	60	100/box	300	088341 <b>96070</b>
	80	100/box	300	088341 <b>96071</b>
	120	100/box	300	088341 <b>96219</b>
3/4 x 1-1/2	24	100/box	300	088341 <b>96596</b>
	60	100/box	300	088341 <b>96554</b>
	80	100/box	300	088341 <b>96249</b>
3/4 x 2	80	100/box	200	088341 <b>96756</b>



TIER: **GOOD**  
 TRADENAME: **R228**  
 ABRASIVE: Aluminum Oxide

SIZE (D x W)	GRIT	STOCK PKG. QTY.	NON-STOCK MOQ	PART #
1 x 1	36	100/box	300	088341 <b>96072</b>
	40	100/box	300	088341 <b>96073</b>
	50	100/box	300	088341 <b>96184</b>
	60	100/box	300	088341 <b>96075</b>
	80	100/box	300	088341 <b>96074</b>
	120	100/box	300	088341 <b>96177</b>
1 x 1-1/2	36	100/box	200	088341 <b>96525</b>
1 x 2	80	100/box	200	088341 <b>96268</b>
	100	100/box	200	088341 <b>96750</b>
1 x 3	36	100/box	100	088341 <b>96665</b>
	50	100/box	100	088341 <b>97688</b>
	60	100/box	100	088341 <b>96676</b>
	80	100/box	100	088341 <b>96195</b>
	120	100/box	100	088341 <b>96197</b>
	1-1/2 x 1-1/2	36	100/box	200
40		100/box	200	088341 <b>96171</b>
50		100/box	200	088341 <b>96176</b>
60		100/box	200	088341 <b>96091</b>
80		100/box	200	088341 <b>96165</b>
120		100/box	200	088341 <b>96066</b>

Some part numbers are non-stock; contact your Norton representative for status, order quantities and lead-times.

Continued





TIER: **GOOD**  
TRADENAME: **R228**  
ABRASIVE: Aluminum Oxide

SIZE (D x W)	GRIT	STOCK PKG. QTY.	NON-STOCK MOQ	PART #
1-1/2 x 2	60	100/box	200	088341 <b>96067</b>
	80	100/box	200	088341 <b>96533</b>
1-1/2 x 3	36	100/box	100	088341 <b>97063</b>
	60	100/box	100	088341 <b>96703</b>
	80	100/box	100	088341 <b>96809</b>
	120	100/box	100	088341 <b>96343</b>
	180	100/box	100	088341 <b>97869</b>
2 x 1	80	100/box	200	088341 <b>96166</b>
	120	100/box	200	088341 <b>96595</b>
2 x 2	36	100/box	200	088341 <b>96110</b>
	40	100/box	200	088341 <b>96172</b>
	60	100/box	200	088341 <b>96173</b>
	80	100/box	200	088341 <b>96181</b>
	120	100/box	200	088341 <b>96585</b>
2 x 3	50	100/box	100	088341 <b>96152</b>
	60	100/box	100	088341 <b>96175</b>
	80	100/box	100	088341 <b>96198</b>
2-1/4 x 3	36	100/box	100	088341 <b>97140</b>
	50	100/box	100	088341 <b>96620</b>
	80	100/box	100	088341 <b>96270</b>
	120	100/box	100	088341 <b>96729</b>
	150	100/box	100	088341 <b>95857</b>



TIER: **GOOD**  
TRADENAME: **R228**  
ABRASIVE: Aluminum Oxide

SIZE (D x W)	GRIT	STOCK PKG. QTY.	NON-STOCK MOQ	PART #
3 x 2	40	100/box	100	088341 <b>96090</b>
	50	100/box	100	088341 <b>96264</b>
	60	100/box	100	088341 <b>96530</b>
	80	100/box	100	088341 <b>96265</b>
3 x 3	120	100/box	100	088341 <b>96531</b>
	24	100/box	100	088341 <b>96256</b>
	36	100/box	100	088341 <b>96262</b>
	40	100/box	100	088341 <b>96555</b>
	50	100/box	100	088341 <b>96253</b>
	60	100/box	100	088341 <b>96188</b>
	80	100/box	100	088341 <b>96159</b>
	100	100/box	100	088341 <b>96250</b>
	120	100/box	100	088341 <b>96572</b>
150	100/box	100	088341 <b>96452</b>	
180	100/box	100	088341 <b>96131</b>	
320	100/box	100	088341 <b>97968</b>	

Some part numbers are non-stock; contact your Norton representative for status, order quantities and lead-times.

## Expanding Rubber Drums

Spiral Bands are easily removed and replaced on the rubber expanding drum.



TIER: **GOOD**  
TRADENAME: **RUBBER EXPANDING DRUMS**

DRUM DIAMETER	WIDTH	SHANK DIAMETER	MAX. RPM	STD. PKG.	PART #
1/4	1/2	1/8	30,000	1	088341 <b>96030</b>
3/8	1/2	1/4	30,000	1	088341 <b>96944 NS</b>
3/8	1	1/8	18,000	1	088341 <b>96011 NS</b>
1/2	1/2	1/4	30,000	1	088341 <b>96904</b>
1/2	1	1/4	15,000	1	088341 <b>96906</b>
1/2	1-1/2	1/4	12,000	1	088341 <b>96907</b>
1/2	2	1/4	10,000	1	088341 <b>96908</b>
3/4	1/2	1/4	27,000	1	088341 <b>96909 NS</b>
3/4	3/4	1/4	24,000	1	088341 <b>96910 NS</b>
3/4	1	1/4	17,000	1	088341 <b>96911</b>
3/4	1-1/2	1/4	10,000	1	088341 <b>96912</b>
3/4	2	1/4	10,000	1	088341 <b>96913</b>

NS Non-stock, contact your Norton representative for current order quantities and lead-times.



TIER: **GOOD**  
TRADENAME: **RUBBER EXPANDING DRUMS**

DRUM DIAMETER	WIDTH	SHANK DIAMETER	MAX. RPM	STD. PKG.	PART #
1	1/2	1/4	20,000	1	088341 <b>96914 NS</b>
1	1	1/4	18,000	1	088341 <b>96916</b>
1	1-1/2	1/4	10,000	1	088341 <b>96917</b>
1	2	1/4	8,000	1	088341 <b>96918</b>
1-1/2	1	1/4	12,000	1	088341 <b>96921</b>
1-1/2	1-1/2	1/4	10,000	1	088341 <b>96922</b>
1-1/2	2	1/4	8,000	1	088341 <b>96923</b>
2	1	1/4	11,000	1	088341 <b>96926</b>
2	1-1/2	1/4	8,000	1	088341 <b>96927</b>
2	2	1/4	6,000	1	088341 <b>96928</b>
3	1	3/8	3,000	1	088341 <b>96929 NS</b>
3	2	3/8	3,000	1	088341 <b>96930 NS</b>
3	3	3/8	3,000	1	088341 <b>96931</b>



Tapered cone points are strips of abrasive cloth rolled and glued to form a solid shape that is designed to break down during use and reveal the next layer of abrasive. Tapered cone points are similar to cartridge rolls but their shape lends greater accessibility to many difficult-to-reach work areas. They are used for deburring holes and in close tolerance work areas.

- Applications:** Used on inside surfaces and inside corners where other abrasive shapes cannot reach. Typically these are used on high-speed air grinders and are always mounted on a mandrel. Ideal for flash removal, polishing, or removing machine tool marks, and edge breaking.
- Grit Range:** 50 - 320
- Abrasive Grain:** Aluminum Oxide
- Backing:** X-weight cotton
- Construction:** Popular sizes and mandrels are listed, with additional sizes available upon request as made-to-order products  
Ceramic alumina and silicon carbide cone points are available upon request as made-to-order products
- Maximum RPM:** 1/8" to 1/2" – 23,000  
5/8" to 1" – 18,000  
1" to 1-1/2" – 15,000
- Machine Used:**  DIE GRINDER

**Application/Grit Recommendation Guide**

COARSER (GRINDING) ←									FINER (FINISHING) →	
36	40	50	60	80	120	180	240	320		
Blending Out Heavy Machine Marks										
Removing Heavy Burrs										
Applying Heavy Scratch Pattern										
Removing Flash/Parting Lines										
Removing Rust/Scale/Pit Marks										
		Preparing Metal for Painting								
		Blending Out Medium Machine Marks								
				Blending Metal Surfaces						
				Applying Light Scratch Pattern						
						Fine Blending and Cleaning				
							Metal Finishing and Polishing			

Good starting specification for flash removal, polishing, or removing machine tool marks and edge breaking on all types of metal in difficult-to-reach work areas



**R228 ALUMINUM OXIDE TAPERED CONE POINTS**

- Quality aluminum oxide abrasive delivers long life
- X-weight cotton cloth provides extended durability, conformability, and superior wear resistance; strong resin bond system provides good grain retention and life
- Full taper construction consisting of rolled and half-glued abrasive strips that break down to expose next layer of abrasive

TIER: <b>GOOD</b>			
TRADENAME: <b>R228</b>			
ABRASIVE: Aluminum Oxide			
SIZE (D x L x H)	GRIT	STD. PKG.	PART #
3/16 x 1 x 2-1/2° Use K-110 Mandrel	50	500	088341 <b>86892</b>
	60	500	088341 <b>86893</b>
	80	500	088341 <b>80918</b>
	100	500	088341 <b>82197</b>
	120	500	088341 <b>82199</b>
	150	500	088341 <b>82200</b>
	180	500	088341 <b>86894</b>
	240	500	088341 <b>86895</b>
320	500	088341 <b>82855</b>	

TIER: <b>GOOD</b>			
TRADENAME: <b>R228</b>			
ABRASIVE: Aluminum Oxide			
SIZE (D x L x H)	GRIT	STD. PKG.	PART #
5/16 x 1-1/2 x 5° Use B-20 Mandrel	80	500	088341 <b>80873</b>
	100	500	088341 <b>82043</b>
	120	500	088341 <b>82717</b>
	150	500	088341 <b>86890</b>
	180	500	088341 <b>82535</b>
	240	500	088341 <b>82044</b>
	320	500	088341 <b>82537</b>

Refer to next page for mandrels.

Continued

### Cartridge and Spiral Roll Mandrels

MODEL #	PILOT DIA.	PILOT LENGTH	SHANK DIA.	SHANK LENGTH	OVERALL LENGTH	PART #
<b>Cartridge and Spiral Roll Mandrels</b>						
M-2E	3/32	3/4	1/4	1	3	088341 <b>83799</b> NS
M-2	3/32	1	1/8	1	3	088341 <b>81202</b>
M-3	1/8	1/2	1/8	1	2-1/2	088341 <b>81203</b>
M-4	1/8	3/4	1/8	1	2-1/2	088341 <b>81204</b>
M-5	1/8	1	1/8	1	2-3/4	088341 <b>81205</b>
M-6	1/8	1-1/2	1/8	1	2-1/2	088341 <b>81206</b> NS
M-7	1/8	1/2	1/4	1-1/4	2-1/4	088341 <b>81207</b>
M-8	1/8	3/4	1/4	1-1/4	2-1/2	088341 <b>81208</b>
M-9	1/8	1	1/4	1-1/4	2-3/4	088341 <b>81209</b>
M-10	1/8	1-1/2	1/4	1-1/4	3-1/4	088341 <b>81210</b>
M-11	1/8	2	1/4	1-1/4	4	088341 <b>81211</b> NS
M-12	3/16	1/2	1/8	1-1/4	2-1/4	088341 <b>81212</b> NS
M-13	3/16	3/4	1/8	1-1/4	2-1/2	088341 <b>81213</b> NS
M-14	3/16	1/2	1/4	1-1/4	2-1/2	088341 <b>81214</b> NS
M-15	3/16	3/4	1/4	1-1/4	2-3/4	088341 <b>81215</b> NS
M-16	3/16	1	1/4	1-1/4	3	088341 <b>81216</b>
M-17	3/16	1-1/2	1/4	1-1/4	3-1/2	088341 <b>81217</b>
M-18	3/16	2	1/4	1-1/4	4	088341 <b>81218</b>
M-19	1/4	1/2	1/4	1-1/4	2-1/2	088341 <b>81219</b> NS
M-20	1/4	3/4	1/4	1-1/4	2-3/4	088341 <b>81220</b> NS
M-21	1/4	1	1/4	1-1/4	3	088341 <b>81221</b>
M-22	1/4	1-1/2	1/4	1-1/4	3-1/2	088341 <b>81222</b>
M-23	1/4	2	1/4	1-1/4	4	088341 <b>81223</b> NS
M-24	5/16	3/4	1/4	1-1/4	2-3/4	088341 <b>81224</b> NS
M-25	5/16	1	1/4	1-1/4	3	088341 <b>81225</b> NS
M-26	5/16	1-1/2	1/4	1-1/4	3-1/2	088341 <b>81226</b> NS
M-27	5/16	2	1/4	1-1/4	4	088341 <b>81227</b> NS

NS Non-stock. Contact your Norton representative for current order quantities and lead-times.  
Standard Package = 1

#### Recommended Pilot Length for Mandrels

3/4 Roll Length	Use 1/2 Pilot
1 Roll Length	Use 3/4 Pilot
1-1/2 Roll Length	Use 1 Pilot
2 Roll Length	Use 1-1/2 Pilot

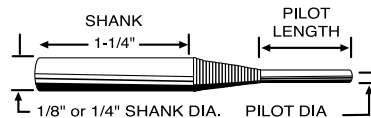

### Extra Shank Length Mandrels for Cartridge Rolls and Spiral Rolls

MODEL #	SHANK LENGTH	OVERALL LENGTH	PART NO.
<b>Extras Shank Length Mandrels</b>			
M-8-4	4	5-1/4	088341 <b>80116</b>
M-8-6	6	7-1/4	088341 <b>80122</b>
M-9-2.5	2-1/2	4	088341 <b>80096</b>
M-9-3	3	4-1/2	088341 <b>80129</b>
M-9-4	4	5-1/2	088341 <b>80074</b> NS
M-9-6	6	7-1/2	088341 <b>80131</b>
M-10-4	1-3/4	4	088341 <b>80092</b> NS
M-10-6	3-3/4	6	088341 <b>80145</b>

All Extra Shank Length mandrels are 1/4" diameter

NS Non-stock. Contact your Norton representative for current order quantities and lead-times.  
Standard Package = 1

### Tapered Cone Point Mandrels

DESCRIPTION	SHANK	PART #
<b>Cone Point Mandrels</b>		
A-10	1/4	088341 <b>81300</b>
B-20	1/4	088341 <b>81301</b>
C-30	1/4	088341 <b>81302</b>
D-40	1/4	088341 <b>81303</b>
E-50	1/4	088341 <b>81304</b>
F-60	1/4	088341 <b>81305</b>
G-70	1/4	088341 <b>81306</b>
I-90	1/4	088341 <b>81308</b>
K-110	1/8	088341 <b>81310</b>

Standard Package = 1



These test kits feature the most popular range and sizes of our coated specialty products in convenient kit formats. Ideal for small job shops, or for travelling to a job site. Our cartridge roll kits are great when you need a small quantity, but a wide range of grits and sizes



#### Ceramic Alumina Cartridge Roll Test Kit

- Part # 662610**66726**
- Kit includes a variety of our ceramic alumina cartridge rolls, spiral rolls and mandrels in popular sizes and grits.



#### Aluminum Oxide Cartridge Roll Test Kit "CR"

- Part # 088341**181061**
- Includes over 120 pieces of our most popular sizes, grits and shapes with their appropriate mandrels.



#### General Purpose Test Kit "GP"

- Part # 088341**169025**
- Includes samples of various abrasive specialties. One of these kits could be worth the cost of the entire kit by solving your problems in deburring, polishing and grinding.



#### Porting Test Kit "APK-MO"

- Part # 088341**169032**
- The samples in this kit highlight specialties for general metal and wood working polishing and finishing applications.



Surface Preparation Stars

The perfect item for ID work



SURFACE PREPARATION STARS

- Star shape design is tough yet conformable to intricate shapes and contours without changing the workpiece dimension
- Premium aluminum oxide grain for excellent cutting and finishing
- Firm durable web for high resistance to tearing on burrs and sharp edges

TIER: **BETTER**  
 TRADENAME: **SURFACE PREP**  
 ABRASIVE: Aluminum Oxide  
 ATTACHMENT: 1/4-20 Eyelet

SIZE (D x EYELET)	GRIT	STD. PKG.	PART #
1-1/2" x 1/4-20	C	100	088341 <b>85923</b>
	M	100	088341 <b>85924</b>
	VF	100	088341 <b>85925</b>
2" x 1/4-20	C	100	088341 <b>85926</b>
	M	100	088341 <b>85927</b>
	VF	100	088341 <b>85928</b>
3" x 1/4-20	C	100	088341 <b>85929</b>
	M	100	088341 <b>85678</b>
	VF	100	088341 <b>85931</b>
4" x 1/4-20	C	100	088341 <b>85932</b>
	M	100	088341 <b>85933</b>
	VF	100	088341 <b>85934</b>

Some part number are non-stock, contact your Norton representative for status, order quantities and lead-times.  
 1/4-20 eyelets attach to MM20-4 mandrel, Part # 088341**83164** (See description at end of Overlap Slotted Disc Section.)

Cross Buffs

Best choice for blending, cleaning and polishing



CROSS BUFFS

- Unique design is tough yet conformable to intricate shapes and contours without changing the workpiece dimension
- Premium aluminum oxide grain for excellent cutting and finishing
- Firm durable web for high resistance to tearing on burrs and sharp edges

TIER: **BEST** **BETTER**  
 TRADENAME: **HIGH STRENGTH** **BUFFING**  
 ABRASIVE: Aluminum Oxide Aluminum Oxide  
 ATTACHMENT: 8-32 Eyelet 8-32 Eyelet

SIZE (D x W)	GRIT	PLY	STD. PKG.	PART #	PART #
1-1/2 x 1/2	Coarse	2	100		088341 <b>88761</b>
	Medium	2	100	088341 <b>89306</b>	088341 <b>87312</b>
	Very Fine	2	100	088341 <b>89307</b>	088341 <b>88585</b>
1-1/2 x 1/2	Coarse	3	100		666233 <b>01763</b>
	Medium	3	100	088341 <b>89308</b>	088341 <b>87311</b>
	Very Fine	3	100	088341 <b>89309</b>	088341 <b>88586</b>

8-32 eyelets: Attach to MM32-4 mandrel. Part No. 088341**83163** (See description at end of Overlap Slotted Disc Section)

Non-Woven Disc Wheels with 1/4" Steel Shank

Best choice for all of your tough stripping needs on all kinds of surfaces



**BLAZE RAPID STRIP DISCS**

- Ceramic alumina grain provides 2X cut rate, 2X life over silicon carbide products
- Advanced resin bond does not shed on rust-encrusted pieces, and prevents gouging and rework; does not snag when used for deburring
- Leave a thoroughly cleaned surface that ensures excellent adhesion for subsequent processes such as coating, painting and soldering

Better choice for light deburring and finishing



**DISC WHEELS**

- Durable, longer lasting aluminum oxide abrasive leaves a more polished finish
- Discs are ganged together to form a wheel that is tough yet conformable to intricate shapes and contours without changing the workpiece dimension
- These wheels are mounted on a 1/4 inch steel mandrel embedded in a strong epoxy core



TIER: **BEST**  
TRADENAME: **BLAZE RAPID STRIP**  
ABRASIVE: Ceramic Alumina

SIZE (D x W x 1/4 SHANK)	GRIT	PLY	MAX. RPM	STD. PKG.	PART #
4 x 1/2	Extra Coarse	1 Ply	8,000	5	776960 <b>05713</b>
4 x 1	Extra Coarse	2 Ply	8,000	5	666233 <b>75051</b>



TIER: **BETTER**  
ABRASIVE: Aluminum Oxide

SIZE (D x W x 1/4 SHANK)	GRIT	PLY	MAX. RPM	STD. PKG.	PART #
2 x 1/2	Medium	2 Ply	12,000	10	088341 <b>31551</b>
2 x 1	Medium	4 Ply	12,000	10	088341 <b>31554</b>
3 x 1/2	Medium	2 Ply	8,000	10	088341 <b>31558</b>
	Very Fine	3 Ply	8,000	10	088341 <b>31560</b>
3 x 1	Medium	4 Ply	8,000	10	088341 <b>31496</b>
	Fine	5 Ply	8,000	10	088341 <b>31557</b>
	Very Fine	5 Ply	8,000	10	088341 <b>31497</b>
4 x 1/2	Fine	3 Ply	6,000	10	088341 <b>31562</b>
4 x 1	Medium	4 Ply	6,000	10	088341 <b>31564</b>
5 x 1/2	Medium	2 Ply	4,000	10	088341 <b>31567</b>
5 x 1	Medium	4 Ply	4,000	10	088341 <b>31570</b>
	Fine	5 Ply	4,000	10	088341 <b>31571</b>

Disc wheels are constructed by number of plies. The actual face width will vary and will not match the listed width exactly. Face width is given for reference only.



Flap wheels are an ideal choice for a wide variety of blending, deburring and finishing applications common in the metal fabrication, welding and polishing industries. Flap wheels are conformable to intricate shapes and contours. Designed to deliver a consistent finish with a uniform rate of cut, flap wheels wear away, continually exposing fresh abrasives.

**Applications:**

Used for a wide range of metal fabrication and welding applications including stock removal, blending, deburring, cleaning, finishing, and polishing

**Size Range:**

Flap wheels with mounted steel shanks: 3/8" - 3" diameter  
Flap wheels with mounted 1/4"-20 thread: 1" - 3" diameter  
Flap wheels with arbor holes: 3" - 16" diameter

**Grit Range:**

40 - 320

**Abrasive Grain:**

Ceramic Alumina, Aluminum Oxide Blend, Aluminum Oxide

**Machine Used:**

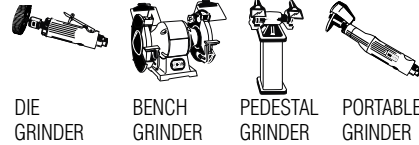



DIE GRINDER

BENCH GRINDER

PEDESTAL GRINDER

PORTABLE GRINDER

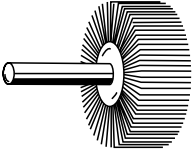
**Shape Recommendation Guide**

Shape	Description/Application
	<p><b>Flap Wheels with Mounted Steel Shanks</b></p> <p>Wheels are designed with a 1/8" or 1/4" steel shank as an integral part of each wheel. These shanks run through the wheel creating better balance, a reduction of chatter, and reduced operator fatigue. They also permit quick changes on air tools when using other abrasive products.</p>
	<p><b>Flap Wheels with Mounted 1/4"-20 Thread</b></p> <p>Wheels are designed with a 1/4"-20 thread and flange as an integral part of the wheel. These threads facilitate the quickest changes on air tools using flap wheels exclusively, as there are no special tools needed to change the flap wheel. Also allow extended reach with accessory mandrels.</p>
	<p><b>Flap Wheels with Arbor Holes</b></p> <p>For use on larger portable and fixed-base tools where the wheel must fit on an existing arbor.</p>

**Application/Grit Recommendation Guide**

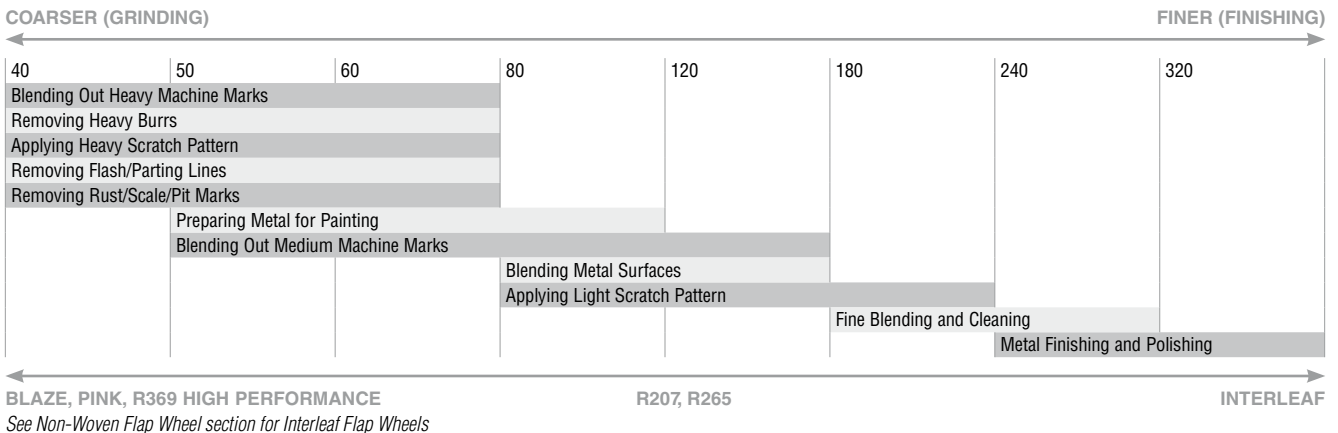



**Best choice for hard-to-grind materials, including superalloys (cobalt, inconel, and titanium) and stainless steel!**

## BLAZE R920 CERAMIC ALUMINA

- See significantly faster, cooler, burn-free results on the toughest jobs from the next-generation of sharp, longest-lasting P-graded ceramic abrasive grains and advanced grinding aid lubricant
- X-weight cotton flaps provide conformability and even wear
- Advanced self-lubricating grain treatment reduces heat on hard-to-grind materials



**Better choice for blending, deburring and finishing on a wide range of materials**

## PINK R928 CERAMIC ALUMINA

- Ceramic grain provides better performance than zirconia alternatives
- Improved resin bond system provides longer life
- Versatile X-weight poly cotton backing for flexibility and life

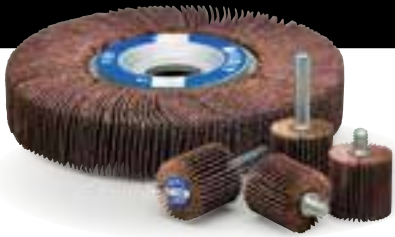

**Good choice for more durable flap wheel applications where aggressive cut and superior life are required**

## R369 HIGH PERFORMANCE ALUMINUM OXIDE BLEND

- Long-lasting premium aluminum oxide blend with 2 to 3 times longer life
- Delivers an excellent cut rate on finishing operations
- Heavy cotton/polyester blended flaps provide extended durability, conformability, and superior wear resistance



**Good choice for more flexible flap wheel applications where finish is required**

## R207 ALUMINUM OXIDE

- P-graded, solid-performing aluminum oxide abrasive delivers uniform stock removal and long life
- Heavy X-weight cotton flaps provide conformability and even wear
- Good general purpose starting specification for small deburring and cleaning jobs



**Good choice when initial price is a key purchasing criteria**

## R265 ALUMINUM OXIDE

- Quality aluminum oxide abrasive provides good cut rate and life
- Heavy cotton/polyester blended flaps provide extended durability, conformability, and superior wear resistance
- Designed for all-purpose use where price is the major consideration





### Micro-Mini Flap Wheels with 1/8" Mounted Steel Shanks

- The smallest flap wheels, ranging from 3/8" to 1-3/16" diameter, mounted on a 1/8" diameter steel shank
- Provide fast polishing and light deburring of internal workpieces with holes or grooves as small as 1/2"



TIER: **GOOD**  
 TRADENAME: **R369**  
 ABRASIVE: Premium Aluminum Oxide  
 BACKING: Y-Weight Cotton

SIZE (D x W x SK.)	GRIT	MAX. RPM	STD. PKG.	PART #
3/8 x 3/8 x 1/8	60	40,000	10	088341 <b>37470</b>
	80	40,000	10	088341 <b>37471</b>
	120	40,000	10	088341 <b>37472</b>
	180	40,000	10	088341 <b>37473</b>
	240	40,000	10	088341 <b>37474</b>
5/8 x 5/8 x 1/8	320	40,000	10	088341 <b>37475</b>
	60	37,000	10	088341 <b>37480</b>
	80	37,000	10	088341 <b>37481</b>
	120	37,000	10	088341 <b>37482</b>
	180	37,000	10	088341 <b>37483</b>
5/8 x 3/4 x 1/8	240	37,000	10	088341 <b>37484</b>
	320	37,000	10	088341 <b>37485</b>
	80	37,000	10	088341 <b>37541</b>
	120	37,000	10	088341 <b>37542</b>
	180	37,000	10	088341 <b>37543</b>
3/4 x 3/16 x 1/8	240	37,000	10	088341 <b>37544</b>
	320	37,000	10	088341 <b>37545</b>
	60	35,000	10	088341 <b>37550</b>
	80	35,000	10	088341 <b>37551</b>
	120	35,000	10	088341 <b>37552</b>
3/4 x 3/8 x 1/8	180	35,000	10	088341 <b>37553</b>
	240	35,000	10	088341 <b>37554</b>
	320	35,000	10	088341 <b>37555</b>
	60	35,000	10	088341 <b>37560</b>
	80	35,000	10	088341 <b>37561</b>
3/4 x 1/2 x 1/8	120	35,000	10	088341 <b>37562</b>
	180	35,000	10	088341 <b>37563</b>
	240	35,000	10	088341 <b>37564</b>
	320	35,000	10	088341 <b>37565</b>
	60	35,000	10	088341 <b>37570</b>
3/4 x 1/2 x 1/8	80	35,000	10	088341 <b>37571</b>
	120	35,000	10	088341 <b>37572</b>
	180	35,000	10	088341 <b>37573</b>
	240	35,000	10	088341 <b>37574</b>
320	35,000	10	088341 <b>37575</b>	



TIER: **GOOD**  
 TRADENAME: **R369**  
 ABRASIVE: Premium Aluminum Oxide  
 BACKING: Y-Weight Cotton

SIZE (D x W x SK.)	GRIT	MAX. RPM	STD. PKG.	PART #
3/4 x 5/8 x 1/8	60	35,000	10	088341 <b>37580</b>
	80	35,000	10	088341 <b>37581</b>
	120	35,000	10	088341 <b>37582</b>
	180	35,000	10	088341 <b>37583</b>
	240	35,000	10	088341 <b>37584</b>
3/4 x 3/4 x 1/8	320	35,000	10	088341 <b>37585</b>
	60	35,000	10	088341 <b>37590</b>
	80	35,000	10	088341 <b>37591</b>
	120	35,000	10	088341 <b>37592</b>
	180	35,000	10	088341 <b>37593</b>
1-3/16 x 1/8 x 1/8	240	35,000	10	088341 <b>37594</b>
	320	35,000	10	088341 <b>37595</b>
	80	30,000	10	088341 <b>37491</b>
	120	35,000	10	088341 <b>37492</b>
1-3/16 x 3/16 x 1/8	180	35,000	10	088341 <b>37493</b>
	320	35,000	10	088341 <b>37495</b>
	60	30,000	10	088341 <b>37508</b>
	80	35,000	10	088341 <b>37501</b>
1-3/16 x 3/8 x 1/8	120	35,000	10	088341 <b>37502</b>
	180	35,000	10	088341 <b>37503</b>
	240	35,000	10	088341 <b>37504</b>
	320	35,000	10	088341 <b>37505</b>
	80	30,000	10	088341 <b>37511</b>
1-3/16 x 3/8 x 1/8	120	35,000	10	088341 <b>37512</b>
	180	35,000	10	088341 <b>37513</b>
	240	35,000	10	088341 <b>37514</b>
	320	35,000	10	088341 <b>37515</b>

*Some part numbers are non-stock; contact your Norton representative for status, order quantities and lead-times.*

### Micro-Mini Test Kit "MMC"

- Part # 088341**131493**
- Includes five wheels, 3/8" to 1-3/16" diameter in various grits, mounted on a 1/8" diameter hardened steel shank
- The "MMC" kit is ideal for fast polishing and light deburring of internal holes or grooves as small as 1/2"



Mini Flap Wheels with 1/4" Mounted Steel Shanks

- Small flap wheels, ranging from 1" to 3" diameter, mounted on a 1/4" diameter steel shank
- Very durable, long-lasting mini flap wheels for demanding, heavy stock removal applications



		TIER: <b>BEST</b>		TIER: <b>BETTER</b>		TIER: <b>GOOD</b>		TIER: <b>GOOD</b>		TIER: <b>GOOD</b>	
		TRADENAME: <b>BLAZE R920</b>		TRADENAME: <b>PINK R928</b>		TRADENAME: <b>R369</b>		TRADENAME: <b>R207</b>		TRADENAME: <b>R265</b>	
		ABRASIVE: Ceramic Alumina		ABRASIVE: Ceramic Alumina		ABRASIVE: Premium Aluminum Oxide		ABRASIVE: Aluminum Oxide		ABRASIVE: Aluminum Oxide	
		BACKING: X-Weight Cotton		BACKING: X-Weight Poly/Cotton		BACKING: Y-Weight Cotton		BACKING: X-Weight Cotton			
SIZE (D x W x SK.)	GRIT	MAX. RPM	STD. PKG.	PART #	PART #	PART #	PART #	PART #	PART #	PART #	PART #
1 x 1/2 x 1/4	80	30,000	10								088341 <b>49801</b>
	120	30,000	10								088341 <b>49802</b>
1 x 5/8 x 1/4	40	30,000	10				088341 <b>137105</b>				
	60	30,000	10				088341 <b>137100</b>	636425 <b>02576</b>			
	80	30,000	10				088341 <b>137101</b>	636425 <b>02577</b>			
	120	30,000	10				088341 <b>137102</b>	636425 <b>02578</b>			
	180	30,000	10				088341 <b>131536</b>				
1 x 1 x 1/4	240	30,000	10				088341 <b>137104</b>				
	40	30,000	10		699573 <b>39701</b>	088341 <b>131259</b>				088341 <b>49803</b>	
	60	30,000	10	662611 <b>151170</b>	699573 <b>39702</b>	088341 <b>137310</b>	636425 <b>02580</b>			088341 <b>49804</b>	
	80	30,000	10	662611 <b>151171</b>	699573 <b>39703</b>	088341 <b>137311</b>	636425 <b>02581</b>			088341 <b>49805</b>	
	120	30,000	10	662611 <b>151172</b>	699573 <b>39704</b>	088341 <b>137312</b>	636425 <b>02582</b>			088341 <b>49806</b>	
	180	30,000	10			088341 <b>137313</b>				088341 <b>49807</b>	
	240	30,000	10			088341 <b>137114</b>					
1-3/8 x 5/8 x 1/4	320	30,000	10			088341 <b>137315</b>					
	60	30,000	10			088341 <b>137320</b>					
	80	30,000	10			088341 <b>137321</b>					
	120	30,000	10			088341 <b>137322</b>					
1-1/2 x 1/2 x 1/4	180	30,000	10			088341 <b>137323</b>					
	240	30,000	10			088341 <b>137324</b>					
	60	25,000	10							088341 <b>49810</b>	
	80	25,000	10							088341 <b>49811</b>	
1-1/2 x 1 x 1/4	40	25,000	10			088341 <b>135140</b>					
	60	25,000	10			088341 <b>137340</b>	636425 <b>02592</b>			088341 <b>49816</b>	
	80	25,000	10			088341 <b>137141</b>	636425 <b>02593</b>			088341 <b>49817</b>	
	120	25,000	10			088341 <b>137142</b>	636425 <b>02594</b>			088341 <b>49818</b>	
	180	25,000	10			088341 <b>137343</b>					
1-1/2 x 1-1/2 x 1/4	240	25,000	10			088341 <b>132101</b>					
	40	25,000	10			088341 <b>130642</b>					
	60	25,000	10			088341 <b>130643</b>					
	80	25,000	10			088341 <b>130644</b>					
	120	25,000	10			088341 <b>130641</b>					
2 x 1/2 x 1/4	180	25,000	10			088341 <b>130695</b>					
	60	25,000	10							088341 <b>49821</b>	
	80	25,000	10							088341 <b>49822</b>	
	120	25,000	10							088341 <b>49823</b>	
2 x 3/4 x 1/4	40	25,000	10			088341 <b>137158</b>					
	60	25,000	10			088341 <b>137160</b>					
	80	25,000	10			088341 <b>137161</b>					
	120	25,000	10			088341 <b>137162</b>					
	180	25,000	10			088341 <b>137163</b>					

Some part numbers are non-stock; contact your Norton representative for status, order quantities and lead-times.  
Continued

Mini Flap Wheels with 1/4" Mounted Steel Shanks *continued*



		TIER: <b>BEST</b>		TIER: <b>BETTER</b>		TIER: <b>GOOD</b>		TIER: <b>GOOD</b>		TIER: <b>GOOD</b>	
		TRADENAME: <b>BLAZE R920</b>		TRADENAME: <b>PINK R928</b>		TRADENAME: <b>R369</b>		TRADENAME: <b>R207</b>		TRADENAME: <b>R265</b>	
		ABRASIVE: Ceramic Alumina		ABRASIVE: Ceramic Alumina		ABRASIVE: Premium Aluminum Oxide		ABRASIVE: Aluminum Oxide		ABRASIVE: Aluminum Oxide	
		BACKING: X-Weight Cotton		BACKING: X-Weight Poly/Cotton		BACKING: Y-Weight Cotton		BACKING: X-Weight Cotton		BACKING: X-Weight Cotton	
SIZE (D x W x SK.)	GRIT	MAX. RPM	STD. PKG.	PART #	PART #	PART #	PART #	PART #	PART #	PART #	PART #
2 x 1 x 1/4	40	25,000	10		699573 <b>39705</b>	088341 <b>37377</b>				088341 <b>49824</b>	
	50	25,000	10			088341 <b>37169</b>					
	60	25,000	10	662611 <b>51173</b>	699573 <b>39706</b>	088341 <b>37370</b>		636425 <b>02600</b>		088341 <b>49825</b>	
	80	25,000	10	662611 <b>51174</b>	699573 <b>39711</b>	088341 <b>37371</b>		636425 <b>02601</b>		088341 <b>49826</b>	
	120	25,000	10	662611 <b>51175</b>	699573 <b>39712</b>	088341 <b>37372</b>		636425 <b>02602</b>		088341 <b>49827</b>	
	180	25,000	10			088341 <b>37373</b>				088341 <b>49828</b>	
	240	25,000	10			088341 <b>37374</b>					
2 x 1-1/2 x 1/4	40	25,000	10			088341 <b>37183</b>					
	60	25,000	10			088341 <b>37380</b>					
	80	25,000	10			088341 <b>37381</b>					
	120	25,000	10			088341 <b>37382</b>					
	180	25,000	10			088341 <b>37383</b>					
2-1/2 x 1 x 1/4	40	20,000	10			088341 <b>37408</b>					
	60	20,000	10			088341 <b>37410</b>		636425 <b>02608</b>			
	80	20,000	10			088341 <b>37411</b>		636425 <b>02609</b>			
	120	20,000	10			088341 <b>37412</b>		636425 <b>02610</b>			
	180	20,000	10			088341 <b>37413</b>					
	240	20,000	10			088341 <b>37633</b>					
	320	20,000	10			088341 <b>37415</b>					
2-1/2 x 1-1/2 x 1/4	60	20,000	10			088341 <b>37420</b>					
	80	20,000	10			088341 <b>37421</b>					
	120	20,000	10			088341 <b>37422</b>					
3 x 1/2 x 1/4	60	20,000	10					636425 <b>02612</b>		088341 <b>49834</b>	
	80	20,000	10					636425 <b>02613</b>		088341 <b>49835</b>	
	120	20,000	10					636425 <b>02614</b>			
3 x 3/4 x 1/4	60	20,000	10			088341 <b>37440</b>					
	80	20,000	10			088341 <b>37441</b>					
3 x 1 x 1/4	40	20,000	10		699573 <b>39713</b>	088341 <b>37456</b>				088341 <b>49836</b>	
	60	20,000	10	662611 <b>51176</b>	699573 <b>39714</b>	088341 <b>37450</b>		636425 <b>02620</b>		088341 <b>49837</b>	
	80	20,000	10	662611 <b>51177</b>	699573 <b>39715</b>	088341 <b>37451</b>		636425 <b>02621</b>		088341 <b>49838</b>	
	120	20,000	10	662611 <b>51178</b>	699573 <b>39716</b>	088341 <b>37252</b>		636425 <b>02622</b>		088341 <b>49839</b>	
	180	20,000	10			088341 <b>37253</b>				088341 <b>49840</b>	
	240	20,000	10			088341 <b>35339</b>					
	320	20,000	10			088341 <b>35341</b>					
3 x 2 x 1/4	40	12,000	10			088341 <b>37460</b>					
	60	12,000	10			088341 <b>37260</b>					
	80	12,000	10			088341 <b>37261</b>					
	120	12,000	10			088341 <b>37262</b>					
	180	12,000	10			088341 <b>37263</b>					

Some part numbers are non-stock; contact your Norton representative for status, order quantities and lead-times.



Mini 1/4" Steel Shank Test Kit "CMM"

- Part # 088341**38004**
- Includes ten wheels, 1" to 3" diameter in various grits mounted on a 1/4" diameter hardened steel shank



**Mini Flap Wheels with 1/4"-20 Thread**

- Mini flap wheels ranging from 1" to 3" diameter, mounted on a 14-20 thread that allows you to quickly spin the wheels on and off with no tools
- Designed for polishing and finishing intricate surfaces; cost-effective replacement for brushes, rubber points, and felt bobs



TIER:	BETTER	GOOD	GOOD
TRADENAME:	<b>PINK R928</b>	<b>R369</b>	<b>R207</b>
ABRASIVE:	Ceramic Alumina	Premium Aluminum Oxide	Aluminum Oxide
BACKING:	X-Weight Poly/Cotton	Y-Weight Cotton	X-Weight Cotton

SIZE (D x W x THD.)	GRIT	MAX. RPM	STD. PKG.	PART #	PART #	PART #
1 x 5/8 x 1/4-20	60	30,000	10		088341 <b>31001</b>	636425 <b>02624</b>
	80	30,000	10		088341 <b>31002</b>	636425 <b>02625</b>
	120	30,000	10		088341 <b>31003</b>	636425 <b>02626</b>
1 x 1 x 1/4-20	40	30,000	10	699573 <b>39718</b>	088341 <b>31027</b>	
	60	30,000	10	699573 <b>39719</b>	088341 <b>31008</b>	636425 <b>02628</b>
	80	30,000	10	699573 <b>39720</b>	088341 <b>31009</b>	636425 <b>02629</b>
	120	30,000	10	699573 <b>39721</b>	088341 <b>31010</b>	636425 <b>02630</b>
	180	30,000	10		088341 <b>31011</b>	
	240	30,000	10		088341 <b>31012</b>	
1-3/8 x 5/8 x 1/4-20	60	30,000	10		088341 <b>32001</b>	636425 <b>02632</b>
	80	30,000	10		088341 <b>32002</b>	636425 <b>02633</b>
	120	30,000	10		088341 <b>32003</b>	636425 <b>02634</b>
1-5/8 x 1 x 1/4-20	40	25,000	10		088341 <b>32051</b>	
	60	25,000	10		088341 <b>32015</b>	636425 <b>02638</b>
	80	25,000	10		088341 <b>32016</b>	636425 <b>02639</b>
	120	25,000	10		088341 <b>32017</b>	636425 <b>02640</b>
	180	25,000	10		088341 <b>32018</b>	
2 x 1/2 x 1/4-20	80	25,000	10			636425 <b>02643</b>
	120	25,000	10			636425 <b>02644</b>
2 x 3/4 x 1/4-20	60	25,000	10		088341 <b>33008</b>	
	80	25,000	10		088341 <b>33009</b>	
	120	25,000	10		088341 <b>33010</b>	
	180	25,000	10		088341 <b>33011</b>	
2 x 1 x 1/4-20	40	25,000	10	699573 <b>39722</b>	088341 <b>33044</b>	
	60	25,000	10	699573 <b>39723</b>	088341 <b>33015</b>	636425 <b>02646</b>
	80	25,000	10	699573 <b>39735</b>	088341 <b>33016</b>	636425 <b>02647</b>
	120	25,000	10	699573 <b>39736</b>	088341 <b>33017</b>	636425 <b>02648</b>
	180	25,000	10		088341 <b>33018</b>	
	240	25,000	10		088341 <b>33019</b>	
2 x 1-1/2 x 1/4-20	60	25,000	10		088341 <b>35201</b>	
	80	25,000	10		088341 <b>35202</b>	
	120	25,000	10		088341 <b>35203</b>	
2-1/2 x 1 x 1/4-20	40	20,000	10		088341 <b>34061</b>	
	60	20,000	10		088341 <b>34022</b>	636425 <b>02654</b>
	80	20,000	10		088341 <b>34023</b>	
	120	20,000	10		088341 <b>34024</b>	
3 x 1/2 x 1/4-20	80	20,000	10			636425 <b>02659</b>
	120	20,000	10			636425 <b>02660</b>
3 x 3/4 x 1/4-20	80	20,000	10		088341 <b>35009</b>	
	120	20,000	10		088341 <b>35010</b>	
3 x 1 x 1/4-20	40	20,000	10	699573 <b>39737</b>	088341 <b>35230</b>	
	60	20,000	10	699573 <b>39738</b>	088341 <b>35015</b>	636425 <b>02664</b>
	80	20,000	10	699573 <b>39739</b>	088341 <b>35016</b>	636425 <b>02665</b>
	120	20,000	10	699573 <b>39740</b>	088341 <b>35017</b>	636425 <b>02666</b>
	180	20,000	10		088341 <b>35018</b>	
	240	20,000	10		088341 <b>35019</b>	

Some part numbers are non-stock; contact your Norton representative for status, order quantities and lead-times.  
For adapters for flap wheels with 1/4"-20 thread, see the end of this section



### Cup-Type Mini Flap Wheels with 1/4" Mounted Steel Shanks

- Primarily used for bottom or side-wall type sanding where conventional tools do not reach
- Cup-type mini flap wheels will not mar your workpiece while reaching flush into areas where other wheels cannot reach

TIER: **GOOD**  
 TRADENAME: **R369**  
 ABRASIVE: Premium Aluminum Oxide  
 BACKING: Y-Weight Cotton

D x W x SK.	MAX. RPM	GRIT	STD. PKG.	PART #
2-1/2 x 1-1/2 x 1/4	20,000	60	10	088341 <b>44463</b>

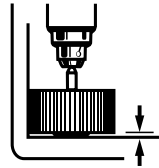

TYPICAL  
WHEELS

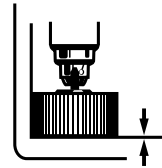

CUP WHEELS GET FLUSH INTO CORNERS  
AND THE BOTTOMS OF CYLINDERS

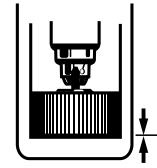

### Flap Wheel Test Kits

#### Mini 1/4"-20 Thread Test Kit "CQ"

- Part # 088341**38001**
- Includes ten, 1" to 3" diameter, 1/4"-20 thread mini flap wheels
- Each kit includes a 1/4"-20 QC-4 quick-change adapter

#### Mini 1/4" Steel Shank Test Kit "CMM"

- Part # 088341**38004**
- Includes ten wheels, 1" to 3" diameter in various grits
- The flap wheels are mounted on a 1/4" diameter hardened steel shank

#### Micro Mini 1/8" Steel Shank Test Kit "MMC"

- Part # 088341**31493**
- Includes 5 wheels, 3/8" to 1-3/16" in diameter
- The flap wheels are mounted on a 1/8" diameter hardened steel shank
- Ideal for fast polishing and light deburring of holes or grooves



### 3" – 8" Flap Wheels with Arbor Holes

- Flap wheels ranging from 3" to 8" diameter with arbor holes
- Heavy cotton backing and premium abrasive grains combine to provide superior life with aggressive cut on a wide range of polishing and finishing applications



TIER:	<b>GOOD</b>	<b>GOOD</b>
TRADENAME:	<b>R369</b>	<b>R207</b>
ABRASIVE:	Premium Aluminum Oxide	Aluminum Oxide
BACKING:	Y-Weight Cotton	X-Weight Cotton

SIZE (D x W x H)	GRIT	MAX. RPM	STD. PKG.	PART #	PART #
3 x 2 x 3/8	60	12,000	10	088341 <b>35050</b>	
	80	12,000	10	088341 <b>35051</b>	
	120	12,000	10	088341 <b>35052</b>	
3-1/2 x 1 x 5/8	40	12,000	10	088341 <b>22001</b>	
	50	12,000	10	088341 <b>22002</b>	
	60	12,000	10	088341 <b>22003</b>	
	80	12,000	10	088341 <b>22004</b>	
	120	12,000	10	088341 <b>22006</b>	
	180	12,000	10	088341 <b>22007</b>	
	240	12,000	10	088341 <b>22008</b>	
3-1/2 x 1-1/2 x 5/8	320	12,000	10	088341 <b>22009</b>	
	40	12,000	10	088341 <b>22011</b>	
	50	12,000	10	088341 <b>22012</b>	
	60	12,000	10	088341 <b>22013</b>	
	80	12,000	10	088341 <b>22014</b>	
	120	12,000	10	088341 <b>22016</b>	
	180	12,000	10	088341 <b>22018</b>	
3-1/2 x 2 x 5/8	320	12,000	10	088341 <b>22020</b>	
	40	12,000	10	088341 <b>22022</b>	
	60	12,000	10	088341 <b>22024</b>	
	80	12,000	10	088341 <b>22025</b>	
	120	12,000	10	088341 <b>22027</b>	
4 x 1 x 5/8	180	12,000	10	088341 <b>22028</b>	
	40	12,000	10	088341 <b>22032</b>	
	50	12,000	10	088341 <b>22033</b>	
	60	12,000	10	088341 <b>22034</b>	636425 <b>02673</b>
	80	12,000	10	088341 <b>22035</b>	636425 <b>02674</b>
4 x 1-1/2 x 5/8	120	12,000	10	088341 <b>22037</b>	636425 <b>02675</b>
	180	12,000	10	088341 <b>22038</b>	
	240	12,000	10	088341 <b>22039</b>	
	320	12,000	10	088341 <b>22040</b>	
	40	12,000	10	088341 <b>22042</b>	
	60	12,000	10	088341 <b>22044</b>	
	80	12,000	10	088341 <b>22045</b>	
4 x 2 x 5/8	120	12,000	10	088341 <b>22047</b>	
	240	12,000	10	088341 <b>22050</b>	
	40	12,000	10	088341 <b>22053</b>	
	60	12,000	10	088341 <b>22055</b>	
	80	12,000	10	088341 <b>22056</b>	
4 x 2 x 5/8	120	12,000	10	088341 <b>22058</b>	
	180	12,000	10	088341 <b>22059</b>	
	240	12,000	10	088341 <b>22060</b>	
	320	12,000	10	088341 <b>22061</b>	

Some part numbers are non-stock; contact your Norton representative for status, order quantities and lead-times.  
For flap wheel with arbor hole adapters and bushings, see the end of this section. A set of reducing bushing will be included for 1" center hole wheels at no charge when purchased with flap wheels and specified on the order.  
Continued

3" – 8" Flap Wheels with Arbor Holes *continued*



		TIER: <b>BEST</b>		GOOD		GOOD		GOOD	
		TRADENAME: <b>BLAZE R920</b>		<b>R369</b>		<b>R207</b>		<b>R265</b>	
		ABRASIVE: Ceramic Alumina		Premium Aluminum Oxide		Aluminum Oxide		Aluminum Oxide	
		BACKING: X-Weight Cotton		Y-Weight Cotton		X-Weight Cotton			
SIZE (D x W x H)	GRIT	MAX. RPM	STD. PKG.	PART #	PART #	PART #	PART #	PART #	PART #
5 x 1-1/2 x 5/8	40	12,000	10		088341 <b>22063</b>				
	50	12,000	10		088341 <b>22064</b>				
	60	12,000	10		088341 <b>22065</b>				
	80	12,000	10		088341 <b>22066</b>				
	120	12,000	10		088341 <b>22068</b>				
	180	12,000	10		088341 <b>22070</b>				
	240	12,000	10		088341 <b>22071</b>				
6 x 1/2 x 1	320	12,000	10		088341 <b>22072</b>				
	40	6,000	10		088341 <b>23001</b>				
	60	6,000	10		088341 <b>23003</b>				
	120	6,000	10		088341 <b>23005</b>				
	150	6,000	10		088341 <b>22198</b>				
6 x 1 x 1	180	6,000	10		088341 <b>23006</b>				
	40	6,000	5		088341 <b>23009</b>			088341 <b>20167</b>	
6 x 1 x 1	50	6,000	5		088341 <b>23010</b>			088341 <b>20168</b>	
	60	6,000	5	662611 <b>46104</b>	088341 <b>23011</b>	636425 <b>02680</b>		088341 <b>20169</b>	
	80	6,000	5	662611 <b>46105</b>	088341 <b>23012</b>	636425 <b>02681</b>		088341 <b>20170</b>	
	100	6,000	5					088341 <b>20171</b>	
	120	6,000	5	662611 <b>46106</b>	088341 <b>23014</b>	636425 <b>02682</b>		088341 <b>20172</b>	
	150	6,000	5		088341 <b>23015</b>				
	180	6,000	5		088341 <b>23016</b>			088341 <b>20174</b>	
	240	6,000	5		088341 <b>23017</b>			088341 <b>20176</b>	
	320	6,000	5		088341 <b>23018</b>			088341 <b>20177</b>	
	6 x 1-1/2 x 1	40	6,000	5		088341 <b>23020</b>			
50		6,000	5		088341 <b>23021</b>				
60		6,000	5		088341 <b>23022</b>	636425 <b>02686</b>			
80		6,000	5		088341 <b>23023</b>	636425 <b>02687</b>			
120		6,000	5		088341 <b>23025</b>				
180		6,000	5		088341 <b>23027</b>				
240		6,000	5		088341 <b>23028</b>				
320		6,000	5		088341 <b>23029</b>				
6 x 2 x 1		40	6,000	5		088341 <b>23031</b>			088341 <b>20189</b>
	50	6,000	5		088341 <b>23032</b>				
	60	6,000	5		088341 <b>23033</b>	636425 <b>02691</b>		088341 <b>20191</b>	
	80	6,000	5		088341 <b>23034</b>	636425 <b>02692</b>		088341 <b>20192</b>	
	100	6,000	5					088341 <b>20198</b>	
	120	6,000	5		088341 <b>23036</b>	636425 <b>02694</b>			
	180	6,000	5		088341 <b>23038</b>			088341 <b>20197</b>	
	240	6,000	5		088341 <b>23039</b>			088341 <b>20199</b>	
	320	6,000	5		088341 <b>23040</b>				
6 x 3 x 1	50	6,000	3		088341 <b>23054</b>				
	60	6,000	3		088341 <b>23055</b>				
	80	6,000	3		088341 <b>23056</b>				
	120	6,000	3		088341 <b>23058</b>				
	180	6,000	3		088341 <b>23060</b>				
8 x 1 x 1	240	6,000	3		088341 <b>23061</b>				
	40	4,500	3		088341 <b>23070</b>				
	50	4,500	3		088341 <b>23071</b>				
	60	4,500	3		088341 <b>23072</b>				
	80	4,500	3		088341 <b>23073</b>				
	120	4,500	3		088341 <b>23075</b>				
	180	4,500	3		088341 <b>23077</b>				
8 x 2 x 1	40	4,500	3		088341 <b>23092</b>				
	50	4,500	3		088341 <b>23093</b>				
	60	4,500	3		088341 <b>23094</b>	636425 <b>02700</b>			
	80	4,500	3		088341 <b>23095</b>	636425 <b>02701</b>			
	120	4,500	3		088341 <b>23097</b>				
	180	4,500	3		088341 <b>23099</b>				
	240	4,500	3		088341 <b>23100</b>				
320	4,500	3		088341 <b>23101</b>					

Some part numbers are non-stock; contact your Norton representative for status, order quantities and lead-times.  
For flap wheel with arbor hole adapters and bushings, see the end of this section.  
A set of reducing bushing will be included for 1" center hole wheels at no charge when purchased with flap wheels and specified on the order.



### 10" – 16" Large Flap Wheels with Arbor Holes

Wide range of applications:

- For polishing/grinding jobs in production work as well as clean-up and maintenance jobs
- Work on metals, plastic, rubber and wood

Easy to operate:

- No adjustments, dressing, or preparation required before or during operation

Fewer rejected parts:

- More forgiving than other abrasive products
- Reduce the possibility of flattening, gouging and surface deformation

TIER: **GOOD**  
TRADENAME: **R369**  
ABRASIVE: Premium Aluminum Oxide  
BACKING: Y-Weight Cotton

SIZE (D x W x H)	GRIT	MAX. RPM	STD. PKG.	PART #
10 x 1 x 1-3/4	40	4,000	4	088341 <b>2223</b>
	80	4,000	4	088341 <b>24003</b>
	120	4,000	4	088341 <b>24005</b>
	180	4,000	4	088341 <b>24007</b>
	240	4,000	4	088341 <b>22889</b>
10 x 1-1/2 x 1-3/4	320	4,000	4	088341 <b>24009</b>
	60	4,000	4	088341 <b>24022</b>
	80	4,000	4	088341 <b>24023</b>
10 x 2 x 1-3/4	180	4,000	4	088341 <b>24027</b>
	60	4,000	2	088341 <b>24042</b>
	80	4,000	2	088341 <b>24043</b>
10 x 3 x 1-3/4	120	4,000	2	088341 <b>24045</b>
	180	4,000	2	088341 <b>24047</b>
	60	4,000	2	088341 <b>24077</b>
12 x 1 x 1-3/4	80	4,000	2	088341 <b>22316</b>
	180	4,000	2	088341 <b>22312</b>
	60	3,000	4	088341 <b>24085</b>
	80	3,000	4	088341 <b>22349</b>
12 x 2 x 1-3/4	120	3,000	4	088341 <b>22311</b>
	180	3,000	4	088341 <b>22315</b>
	40	3,000	2	088341 <b>22248</b>
	50	3,000	2	088341 <b>22249</b>
12 x 4 x 1-3/4	60	3,000	2	088341 <b>22250</b>
	120	3,000	2	088341 <b>22269</b>
	150	3,000	2	088341 <b>22270</b>
	180	3,000	2	088341 <b>22271</b>
	240	3,000	2	088341 <b>22273</b>
	320	3,000	2	088341 <b>22275</b>

TIER: **GOOD**  
TRADENAME: **R369**  
ABRASIVE: Premium Aluminum Oxide  
BACKING: Y-Weight Cotton

SIZE (D x W x H)	GRIT	MAX. RPM	STD. PKG.	PART #
14 x 1 x 1-3/4	60	2,400	1	088341 <b>20020</b>
	120	2,400	1	088341 <b>20022</b>
14 x 2 x 1-3/4	60	2,400	1	088341 <b>20028</b>
	80	2,400	1	088341 <b>23215</b>
	120	2,400	1	088341 <b>22907</b>
14 x 3 x 1-3/4	240	2,400	1	088341 <b>20032</b>
	120	2,400	1	088341 <b>20035</b>
	240	2,000	1	088341 <b>20041</b>
16 x 1 x 1-3/4	80	2,400	1	088341 <b>20043</b>
	120	2,400	1	088341 <b>20044</b>
	240	2,400	1	088341 <b>20046</b>
16 x 2 x 1-3/4	60	2,400	1	088341 <b>20047</b>
	120	2,400	1	088341 <b>20050</b>
	180	2,400	1	088341 <b>20051</b>
	240	2,400	1	088341 <b>20052</b>
16 x 3 x 1-3/4	120	2,400	1	088341 <b>20055</b>

*Some part numbers are non-stock; contact your Norton representative for status, order quantities and lead-times.*

*For flap wheel with arbor hole adapters and bushings, see the end of this section.*



Adapter and Bushings for Flap Wheels with Arbor Holes

WHEEL DIAMETER	ADAPTERS	PART #
<b>Shank Adapters</b>		
3-1/2	1/4 Shank	088341 <b>25001</b>
3-1/2	3/8 Shank	088341 <b>25007 NS</b>
4-8	1/4 Shank	088341 <b>25003</b>
<b>Threaded Mounting Adapters</b>		
4-8	5/8-11 Thread	088341 <b>25027</b>
<b>Reducing Bushings</b>		
6-8	1 to 3/8	088341 <b>25016 NS</b>
	1 to 1/2	088341 <b>25017</b>
	1 to 5/8	088341 <b>25018 NS</b>
	1 to 3/4	088341 <b>25019 NS</b>
	1 to 7/8	088341 <b>25020 NS</b>
10-16	1 to 5/8	088341 <b>22069 NS</b>

Standard packages = 1 adapter, 1 pair of bushings  
 NS Non-stock. Contact your Norton representative for current order quantities and lead-times.  
 For additional aluminum reducing bushings see non-woven convolute wheel section



Adapters for 1/4"-20 Thread Mini and Arbor Hole Flap Wheels

MODEL #	DESCRIPTION	PART #
<b>Adapters</b>		
ADAPT C	Fits 3 x 2 x 3/8 arbor flap wheel	088341 <b>37009 NS</b>
MA-100	Fits A.H. Mini Wheel	088341 <b>37007 NS</b>
QC-8	1/8 x 5/8	088341 <b>37002 NS</b>
QC-4	1/4 SK. Dia. x 5/8 SK. L.	088341 <b>37001</b>
QC-44	1/4 x 4	088341 <b>37003</b>
QC-46	1/4 x 6	088341 <b>37004</b>
QC-48	1/4 x 8	088341 <b>37005</b>
QC-T	1/4-20 Thread	088341 <b>37012</b>
QC-T	3/8-24 Thread	088341 <b>37010</b>

Standard package = 1 adapter  
 Other thread sizes available for quotation  
 NS Non-stock. Contact your Norton representative for current order quantities and lead-times.

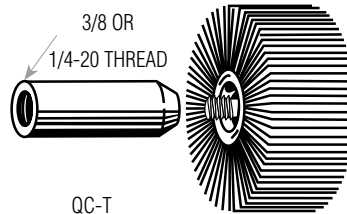
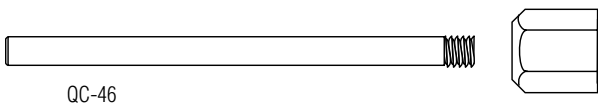
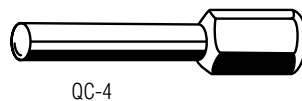



### Sand-O-Flex Wheels

With their firm cushioning brushes, Sand-O-Flex's abrasive strips are forced into, around and over corners, hollow and fluted surfaces, and small openings. Pressure is distributed evenly over the surface to prevent loss of detail and the flattening of rounded areas; for sanding metals, woods, plastics, rubber and ceramic.

Sand-O-Flex wheels eliminate the need to hand-sand and are designed to fit most standard equipment. They load quickly and easily by turning the index knob as needed, allowing you to change grit size in minutes. Sand-O-Flex refills are available both scored (for finer, less aggressive work) and unscored. And, with the use of adapters, Sand-O-Flex wheels will fit most electric bench grinders.

#### Sand-O-Flex Wheel – Model 350-RP

- Diameter: 6-1/2" overall, 4" diameter high-impact plastic body
- 1" wide abrasive strips backed by 8 cushioning brushes
- 1/4" diameter steel shank
- Weight: 9-1/2 oz.
- Maximum operating speed: 2,400 RPM
- Special adapter required for bench grinder use
- Some assembly required

TIER: **GOOD**  
TRADENAME: **SAND-O-FLEX**  
ABRASIVE: Aluminum Oxide

MODEL #	GRIT	STD. PKG.	PART #
<b>Sand-O-Flex Wheel</b>			
350-RP		1	088341 <b>11051</b>
<i>Comes assembled with 80 grit A/O resin bond scored refill and brushes</i>			
<b>Sand-O-Flex Accessories</b>			
Replacement Brushes for 350-RP; 8 per set		1 set	088341 <b>13003</b>
<b>Resin Bond Refills</b>			
350-RP SCORED	60	10	088341 <b>11052</b>
	80	10	088341 <b>11053</b>
	100	10	088341 <b>12114</b>
	120	10	088341 <b>11054</b>
	180	10	088341 <b>11057</b>
<b>Glue Bond Refills</b>			
350-RP SCORED	80	10	088341 <b>12054</b>
	100	10	088341 <b>12055</b>
	120	10	088341 <b>12056</b>
350-RP UNSCORED	80	10	088341 <b>12044</b>





Non-woven surface finishing flap wheels are an ideal choice for a wide variety of blending and finishing applications common in the metal fabrication, welding and polishing industries. Flap wheels are conformable to intricate shapes and contours. Designed to deliver a consistent finish with a uniform rate of cut, flap wheels wear away continually exposing fresh abrasives.

There are two types of non woven flap wheels: non-woven only abrasive flaps where finishing is the primary application, and interleaf with alternating cloth and non-woven abrasive flaps (less conformable, more aggressive) for stock removal and finishing. Interleaf flap wheels must always be run in the direction indicated by the arrow.

**Applications:** Used for a wide range of metal fabrication and welding applications including blending, deburring, cleaning, finishing, and polishing

**Size Range:** Flap wheels with mounted steel shanks: 2" – 4" diameter  
Flap wheels with arbor holes: 3" – 12" diameter

**Grit Range:** 60 – 320

**Abrasive Grain:** Aluminum Oxide

**Machine Used:**

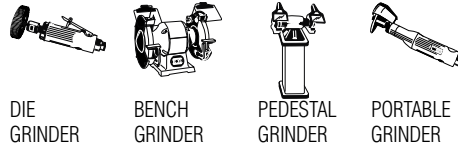

DIE GRINDER

BENCH GRINDER

PEDESTAL GRINDER

PORTABLE GRINDER

### Application/Grit Recommendation Guide

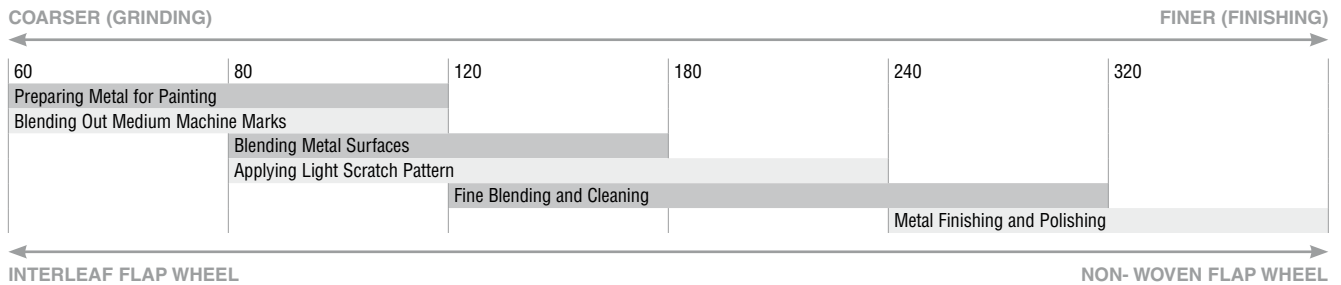

Good choice for fine grit cleaning and blending and finishing applications



### INTERLEAF

- Alternating cloth and non-woven flaps make interleaf wheels less conforming and more aggressive than non-woven flap wheels, but less aggressive than all-cloth flap wheels
- Premium aluminum oxide grain with durable resin bond and web that wears away continually exposing fresh abrasives
- Tough yet conformable to intricate shapes and contours without changing the workpiece dimension

Good choice for fine grit light cleaning and finishing



### NON-WOVEN

- Premium aluminum oxide grain with durable resin bond and web that wears away continually exposing fresh abrasives
- Tough yet conformable to intricate shapes and contours without changing the workpiece dimension
- Designed with a steel shank as an integral part of the wheel or with an arbor hole

### 1/4" Mounted Steel Shanks

Wheels are designed with a 1/4" steel shank as an integral part of each wheel. These shanks run through the wheel creating better balance, a reduction of chatter, and reduced operator fatigue. They also permit quick changes on air tools when using other abrasive products.

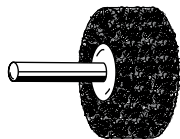

SIZE (D x W x SK.)	ABRASIVE	COATED GRIT	NON-WOVEN GRIT	MAX. RPM	STD. PKG.	TIER: <b>GOOD</b>	
						TRADENAME: <b>INTERLEAF</b>	<b>NON-WOVEN</b>
						PART #	PART #
2 x 1 x 1/4	A/O	60	Very Fine	12,000	10	088341 <b>38122</b>	
	A/O	80	Very Fine	12,000	10	088341 <b>38123</b>	
	A/O		Medium	12,000	20		662611 <b>89992*</b>
	A/O	120	Very Fine	12,000	10	088341 <b>44457</b>	
	A/O	180	Very Fine	12,000	10	088341 <b>44458</b>	
2 x 1-1/2 x 1/4	A/O	320	Very Fine	12,000	10	088341 <b>44459</b>	699573 <b>99202</b>
	A/O	80	Very Fine	12,000	10	088341 <b>38125</b>	
	A/O	120	Very Fine	12,000	10	088341 <b>38126</b>	
3 x 1 x 1/4	A/O	320	Very Fine	12,000	10	088341 <b>38128</b>	
	A/O	60	Very Fine	12,000	10	088341 <b>38129</b>	
	A/O	80	Very Fine	12,000	10	088341 <b>38130</b>	
3 x 1 x 1/4	A/O		Medium	12,000	10		088341 <b>31921</b>
	A/O	120	Very Fine	12,000	10	088341 <b>38118</b>	
	A/O	180	Fine	12,000	10	088341 <b>38120</b>	
	A/O	320	Very Fine	12,000	10	088341 <b>38119</b>	
	3 x 2 x 1/4	A/O	120	Very Fine	8,000	10	088341 <b>44460</b>
A/O		180	Very Fine	8,000	10	088341 <b>44461</b>	
4 x 2 x 1/4	A/O	80	Very Fine	12,000	10	088341 <b>21115</b>	
	A/O	120	Very Fine	12,000	10	088341 <b>20458</b>	

\*Standard package quantity = 20

### Arbor Hole Mounts

For use on larger portable and fixed-base tools where the wheel must fit on an existing arbor.



SIZE (D x W x SK.)	ABRASIVE	COATED GRIT	NON-WOVEN GRIT	MAX. RPM	STD. PKG.	TIER: <b>GOOD</b>	
						TRADENAME: <b>INTERLEAF</b>	<b>NON-WOVEN</b>
						PART #	PART #
3 x 2 x 3/8	A/O	60	Very Fine	12,000	10	088341 <b>39000</b>	
	A/O	120	Very Fine	12,000	10	088341 <b>39001</b>	
	A/O	240	Very Fine	12,000	10	088341 <b>39028</b>	
	A/O	320	Very Fine	12,000	10	088341 <b>39024</b>	
4 x 2 x 5/8	A/O	60	Very Fine	12,000	10	088341 <b>26025</b>	
	A/O	240	Very Fine	12,000	10	088341 <b>26014</b>	
	A/O	320	Very Fine	12,000	10	088341 <b>26027</b>	
6 x 1 x 1	A/O	120	Very Fine	6,000	10	088341 <b>26006</b>	
	A/O	240	Very Fine	6,000	10	088341 <b>26030</b>	
6 x 1 x 2	S/C	-	Very Fine	3,000	4		055395 <b>12658</b>
6 x 2 x 1	A/O	80	Very Fine	6,000	10	088341 <b>26009</b>	
	A/O	180	Very Fine	6,000	10	088341 <b>26018</b>	
6 x 3 x 1	A/O	80	Very Fine	6,000	6	088341 <b>26055</b>	
8 x 2 x 3	A/O	-	Medium	2,500	2		055395 <b>12677</b>
12 x 2 x 5	A/O	-	High Strength	1,900	1		055395 <b>62637</b>

Refer to Non-Woven  
Convolute Wheel  
section for Flap Wheel  
Reducing Bushings.

### Non-Woven High Strength Discs

Applications include rust/oxide or coating removal, pipe ID and OD polishing, casting cleaning, highlighting (antiquing), contaminant removal, removal of handling marks, gasket removal, cleaning and blending of surface imperfections, prepping prior to soldering, removal of filling materials, cleaning angles and odd shapes. Will not stretch or shed. Ganging increases versatility. For use on larger portable and fixed-base tools where the wheel must fit on an existing arbor.

Best choice for light deburring and finishing



## HIGH STRENGTH DISCS

- Premium aluminum oxide grain; engineered for more demanding applications
- Tough but flexible web resists tearing on burrs and sharp edges; and conforms to intricate shapes and contours without changing the workpiece dimension; can be ganged together and used as a wheel
- Smear-free bond excels at producing light satin finishes

TIER: **BEST**

TRADENAME: **HIGH STRENGTH**

ABRASIVE: Aluminum Oxide

SIZE (D x H)	GRIT	MAX. RPM	STD. PKG.	PART #
6 x 1/4	VF	4,000	70	662610 <b>07628</b>
6 x 1/2	M	4,000	70	662610 <b>05073</b>
	VF	4,000	70	662610 <b>04980</b>
8 x 1/2	M	3,000	50	662610 <b>05491</b>
	VF	3,000	50	662610 <b>04506</b>
12 x 1-1/4	VF	1,900	25	662610 <b>08723</b>



FITS HOLE	FOR DISC WIDTH	FOR DISC DIAMETER	SHANK DIAMETER	OVERALL LENGTH	WASHER DIAMETER	STD. PKG.	PART #
<b>Mandrel Assemblies For Using Discs On Edge</b>							
1/4"	1/2" (Standard)	up to 6"	1/4"	2-1/2"	1-1/2"	1	662610 <b>09502</b>
1/2"	1/2" (Standard)	Up to 8"	1/4"	3-1/8"	2-1/4"	1	662610 <b>59420</b>



Flaps of abrasive cloth are stacked, inserted into a holder, and then attached to a mandrel. The flaps are designed to break down during use and reveal the next layer of abrasive.

To create an interleaf bore polisher, cloth flaps are mixed with non-woven flaps.

**Applications:**

For deburring, sizing, cleaning and polishing the interior diameters of cylinders, tubes and hydraulic fittings. Flaps adjust automatically to inside diameter, polishing the entire surface area with each pass.

Bore polishers are self-centering, so they apply equal pressure to full wall of inside diameter. Spring action design gives faster inside diameter cleaning, deburring and polishing to cylinders, deep bores and tubes.

Interleafed bore polishers are designed to polish and finish in one easy application. The abrasive flaps cut, while the non-woven flaps apply a fine finish.

**Grit Range:**

60 - 240

**Abrasive Grain:**

Aluminum Oxide

**Application-to-Product Shape Recommendation Guide**

**Shape**

Solid Flaps  
B-3 Series



**Application**

- For 5/8" to 1" interior diameter bores
- 3 abrasive packs 1-1/2" wide, bonded to hub
- Use with QC-5 mandrel Part # 088341**54182**

Solid Flaps  
B-4 Series



- For 1" to 4" interior diameter bores
- 4 abrasive packs 1-1/2" wide, bonded to hub
- Use with BPM-4 mandrel Part # 088341**54183**

Solid Flaps  
B-8 Series



- For 2" to 5-7/8" interior diameter bores
- 8 abrasive packs 1-1/2" wide, bonded to hub
- Use with BPM-8 mandrel Part # 088341**54184**

Scored Flaps

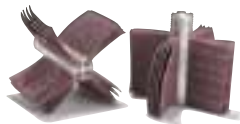

Available upon request as made-to-order products.

Interleaf



Cloth flaps are mixed with non-woven flaps. Interleaf bore polishers do double duty. Designed to polish and finish in one easy application, they are the ideal choice when close tolerances must be maintained, while giving an interior a polished finish.

**Application/Grit Recommendation Guide**

COARSER (MATERIAL REMOVAL) ←					→ FINER (FINISHING)									
60	80	120	180	240										
Blending Out Medium Machine Marks														
Sizing Cylinders														
		Deburring Cylinders												
		Blending Metal Surfaces												
		Cleaning Cylinders												
		Applying Light Scratch Pattern												
			Fine Blending and Cleaning											
			Metal Finishing and Polishing											
← SOLID FLAP					SCORED					INTERLEAF →				

**Aluminum Oxide Bore Polishers**

TIER: **GOOD**  
TRADENAME: **R369**  
ABRASIVE: Aluminum Oxide  
BACKING: Y-weight Cotton/Poly

DESCRIPTION	GRIT	MAX. RPM	STD. PKG.	PART #
<b>Bore Polishers – Solid Flap B-3 and B-4 Series</b>				
B-305	60	25,000	10	088341 <b>54190</b>
Fits ID 5/8 to 1	80	25,000	10	088341 <b>54191</b>
	120	25,000	10	088341 <b>54193</b>
	180	25,000	10	088341 <b>54195</b>
	240	25,000	10	088341 <b>54197</b>
	B-405	60	22,000	10
Fits ID 1 to 1-1/2	80	22,000	10	088341 <b>54092</b>
	120	22,000	10	088341 <b>54093</b>
	180	22,000	10	088341 <b>54094</b>
B-410	60	20,000	10	088341 <b>54100</b>
Fits ID 1-1/2 to 2	80	20,000	10	088341 <b>54101</b>
	120	20,000	10	088341 <b>54102</b>
	180	20,000	10	088341 <b>54103</b>
	240	20,000	10	088341 <b>54104</b>
B-415	60	16,000	10	088341 <b>54109</b>
Fits ID 2-1/8 to 2-1/2	80	16,000	10	088341 <b>54110</b>
	120	16,000	10	088341 <b>54111</b>
	180	16,000	10	088341 <b>54112</b>
B-420	60	15,000	10	088341 <b>54118</b>
Fits ID 2-1/2 to 3	80	15,000	10	088341 <b>54119</b>
	120	15,000	10	088341 <b>54120</b>
	180	15,000	10	088341 <b>54121</b>
	240	15,000	10	088341 <b>54122</b>
B-425	60	10,000	10	088341 <b>54127</b>
Fits ID 3-1/8 to 4	80	10,000	10	088341 <b>54128</b>
	120	10,000	10	088341 <b>54129</b>
	180	10,000	10	088341 <b>54130</b>

NS Non-stock. Contact your Norton representative for current order quantities and lead-times.

TIER: **GOOD**  
TRADENAME: **R369**  
ABRASIVE: Aluminum Oxide  
BACKING: Y-weight Cotton/Poly

DESCRIPTION	GRIT	MAX. RPM	STD. PKG.	PART #
<b>Bore Polishers – Solid Flap B-8 Series</b>				
B-810	60	16,000	10	088341 <b>54136</b>
Fits ID 2 to 2-1/2	80	16,000	10	088341 <b>54137</b>
	120	16,000	10	088341 <b>54138</b>
	180	16,000	10	088341 <b>54139 NS</b>
	240	16,000	10	088341 <b>54140 NS</b>
	B-815	60	15,000	10
Fits ID 2-5/8 to 3	80	15,000	10	088341 <b>54146</b>
	120	15,000	10	088341 <b>54147</b>
	180	15,000	10	088341 <b>54148 NS</b>
	240	15,000	10	088341 <b>54149 NS</b>
B-820	60	10,000	10	088341 <b>54154</b>
Fits ID 3-1/8 to 4	80	10,000	10	088341 <b>54155</b>
	120	10,000	10	088341 <b>54156</b>
	180	10,000	10	088341 <b>54157</b>
	240	10,000	10	088341 <b>54158 NS</b>
	B-825	60	8,000	10
Fits ID 4-1/4 to 5-1/4	80	8,000	10	088341 <b>54164</b>
	120	8,000	10	088341 <b>54165</b>
	180	8,000	10	088341 <b>54166</b>
	240	8,000	10	088341 <b>54167</b>
B-830	60	8,000	10	088341 <b>54172</b>
Fits ID 5-1/4 to 5-7/8	80	8,000	10	088341 <b>54173</b>
	120	8,000	10	088341 <b>54174</b>
	180	8,000	10	088341 <b>54175</b>
	240	8,000	10	088341 <b>54176</b>

**Bore Polishers – Scored Flaps**

Available on request as made-to-order products

**Bore Polishers – Interleaf**

DESCRIPTION	GRIT	MAX. RPM	STD. PKG.	PART #
B-405 Interleaf	80	22,000	10	088341 <b>50271</b>
Fits ID 1 to 1-1/2	180	22,000	10	088341 <b>50273</b>

**Mandrels for Bore Polishers**

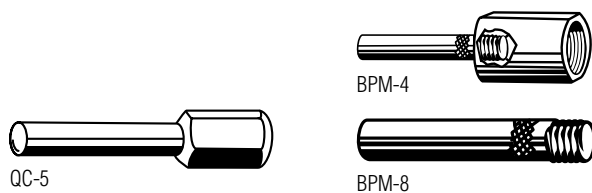

DESCRIPTION	MODEL NO.	THREAD	STD. PKG.	PART #
For B-3 Series	QC-5	5/16-18	1	088341 <b>54182</b>
For B-4 Series	BPM-4	1/2-20	1	088341 <b>54183</b>
For B-8 Series	BPM-8	1/4-20	1	088341 <b>54184</b>

**Extension Mandrels for Bore Polishers**

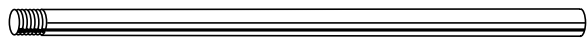

DIAMETER x LENGTH	MODEL NO.	THREAD	STD. PKG.	PART #
1/4 x 4	EM-144	1/4-20	1	088341 <b>54185</b>
1/4 x 6	EM-146	1/4-20	1	088341 <b>54186</b>
1/4 x 8	EM-148	1/4-20	1	088341 <b>54187</b>

To extend a B-4 series bore polisher, attach the adapter piece of the BPM-4 mandrel to the bore polisher, then attach the desired length extension mandrel above to the BPM-4 adapter piece. To extend a B-8 series bore polisher, attach the desired length extension mandrel above directly to the bore polisher.

**Bore Polisher Test Kit “BP”**

- Part # 088341**54181**
- Contains ten bore polishers and two mini 1/4"-20 thread flap wheels in assorted sizes and grits for finishing 1" to 5" interior diameters, and mandrel for 1/4" chuck.





FlexDrum abrasive segments sweep away flaws. Their extreme longevity and perfect balance make them well-suited for automatic as well as offhand use. Hubs and abrasive segments can be combined to fit your job perfectly.

**Applications**

Blending out parting lines on castings, smoothing out pre-ground welded areas, removing burrs and work flaws, graining stainless, brush-finishing and satin-finishing aluminum, removing rust, deflashing molded plastic and rubber parts, and preparing surfaces for painting or plating.

**Size Range:**

Diameter of loaded FlexDrum: 8" – 18"  
Width of FlexDrum: 1-1/2" – 12"  
Custom die-cut segments as well as extra wide segments, in widths up to 144" are also available as made-to-order products.

**Grit Range:**

50 – 240

**Bond:**

Resin or glue

**Backing:**

Heavyweight cotton

**Abrasive Grain:**

Premium Aluminum Oxide

**Shape/Application Recommendation Guide**

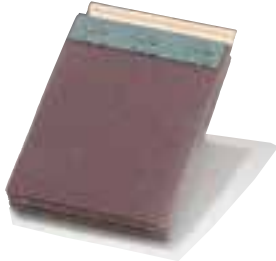

**Plain Segment**

- For flat or mildly contoured surfaces



**1/4 Scored (SC) Segment**

- Great for complex parts
- Provides a fine finish



**1/2 Slash (SL) Segment**

- Great for mild and moderate contours

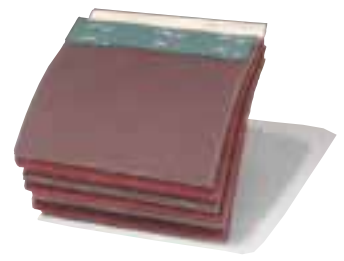

**Interleaf Segment**

- Plain cloth segments are mixed with non-woven segments. Interleaf FlexDrums do double duty. Designed to polish and finish in one easy application,
- Available upon request as made-to-order product

**Loading Flex Drum Hubs**



FlexDrum hub end plate removes for easy loading of abrasive segments.



Custom profiled segments eliminate break-in resulting in maximum productivity. Contact your sales representative for more information.



### Plain Segments – for flat or mildly curved surfaces

TIER: <b>GOOD</b>									
TRADENAME: <b>R369</b>									
ABRASIVE: A/O									
BACKING: Y-weight Cotton									
GRIT: 50 60 80 100 120 180 240									
WIDTH	TRIM LENGTH*	STD. PKG.	PART #	PART #	PART #	PART #	PART #	PART #	PART #
1-1/2	2-3/4	12	088341 <b>55002</b>	088341 <b>55003</b>	088341 <b>55004</b>		088341 <b>55006</b>	088341 <b>55008</b>	088341 <b>55010</b>
2	2-3/4	12	088341 <b>55013</b>	088341 <b>55014</b>	088341 <b>55015</b>	088341 <b>55016</b>		088341 <b>55019</b>	
2	4	20		088341 <b>55313</b>	088341 <b>55314</b>	088341 <b>55315</b>		088341 <b>55318</b>	
2	5	20		088341 <b>55568</b>	088341 <b>55569</b>				
3	2-3/4	12		088341 <b>55026</b>	088341 <b>55027</b>		088341 <b>55029</b>	088341 <b>55031</b>	
3	4	20			088341 <b>55326</b>			088341 <b>55330</b>	
3	5	20		088341 <b>55579</b>			088341 <b>55582</b>	088341 <b>55584</b>	
4	2-3/4	12	088341 <b>55036</b>				088341 <b>55040</b>		
4	4	20	088341 <b>55336</b>	088341 <b>55337</b>	088341 <b>55338</b>		088341 <b>55340</b>		
4	5	20		088341 <b>55590</b>					

All FlexDrum segments are non-stock; contact your Norton representative for current order quantities and lead-times.

### 1/4" Scored Segments – for complex parts and providing a fine finish

TIER: <b>GOOD</b>									
TRADENAME: <b>R369</b>									
ABRASIVE: A/O									
BACKING: Y-weight Cotton									
GRIT: 50 60 80 100 120 180									
WIDTH	TRIM LTH.*	SCORE	STD. PKG.	PART #	PART #	PART #	PART #	PART #	PART #
1-1/2	2-3/4	1/4	12		088341 <b>55083</b>	088341 <b>55084</b>	088341 <b>55085</b>	088341 <b>55086</b>	088341 <b>55088</b>
2	2-3/4	1/4	12	088341 <b>55094</b>	088341 <b>55095</b>	088341 <b>55096</b>	088341 <b>55097</b>	088341 <b>55098</b>	088341 <b>55100</b>
3	2-3/4	1/4	12		088341 <b>55107</b>	088341 <b>55108</b>	088341 <b>55109</b>		088341 <b>55112</b>
4	2-3/4	1/4	12	088341 <b>55117</b>	088341 <b>55118</b>	088341 <b>55119</b>		088341 <b>55121</b>	088341 <b>55123</b>

All FlexDrum segments are non-stock; contact your Norton representative for current order quantities and lead-times.

### 1/2" Slashed Segments – for mild and moderate contours

TIER: <b>GOOD</b>									
TRADENAME: <b>R369</b>									
ABRASIVE: A/O									
BACKING: Y-weight Cotton									
GRIT: 60 80 120 180 240									
WIDTH	TRIM LTH.*	SLASH	STD. PKG.	PART #	PART #	PART #	PART #	PART #	PART #
2	4	1/2	20	088341 <b>55420</b>	088341 <b>55421</b>	088341 <b>55423</b>	088341 <b>55425</b>	088341 <b>55427</b>	
2	5	1/2	20			088341 <b>55639</b>			
3	4	1/2	20		088341 <b>55432</b>				
4	4	1/2	20		088341 <b>55445</b>	088341 <b>55447</b>	088341 <b>55449</b>	088341 <b>55451</b>	
4	5	1/2	20		088341 <b>55659</b>				

All FlexDrum segments are non-stock; contact your Norton representative for current order quantities and lead-times.

\*Trim Length is the actual usable length of segment when loaded

## TECH TIP

FlexDrums can be used for polishing large IDs. Just load half the segments with a wheel diameter 1/2" to 1" larger than the ID of your workpiece.

### Hub Units

- FlexDrum hubs are perfectly balanced, last indefinitely and are available in widths from 1-1/2" to 12"
- Extra wide widths are available up to 144" as made-to-order products

MODEL NO.	D x W	ARBOR HOLE/THREAD	SEGMENTS PER HUB	PART #
<b>FlexDrum Hub Units</b>				
81.5-B	2-3/8 x 1-1/2	1 AH	12	088341 <b>40065</b>
82-B	2-3/8 x 2	1 AH	12	088341 <b>41049</b>
		5/8-11 THD	12	088341 <b>40048</b>
83-B	2-3/8 x 3	1 AH	12	088341 <b>41018</b>
		5/8-11 THD	12	088341 <b>40034</b>
84-B	2-3/8 x 4	1 AH	12	088341 <b>40066</b>
		5/8-11 THD	12	088341 <b>40049</b>
122-B	4 x 2	1-1/4 AH	20	088341 <b>40050</b>
123-B	4 x 3	1-1/4 AH	20	088341 <b>40051</b>
124-B	4 x 4	1-1/4 AH	20	088341 <b>40061</b>
142-B	6 x 2	1-1/4 AH	30	088341 <b>40062</b>
143-B	6 x 3	1-1/4 AH	30	69957 <b>99208</b>
144-B	6 x 4	1-1/4 AH	30	088341 <b>41060</b>
840-B2	8 x 2	1-1/4 AH	40	636425 <b>92550</b>
840-B4	8 x 4	1-1/4 AH	40	636425 <b>92548</b>

All FlexDrum hub units are non-stock; contact your Norton representative for current order quantities and lead-times.



**2-3/8" DIAMETER HUB  
WITH 1" ARBOR HOLE**

8" WHEEL WHEN LOADED



**2-3/8" DIAMETER HUB ALSO  
AVAILABLE WITH 5/8"-11 ARBOR**

8" WHEEL WHEN LOADED



**4" DIAMETER HUB**

12" WHEEL WHEN LOADED



**6" DIAMETER HUB**

14" OR 16" WHEEL WHEN LOADED



**8" DIAMETER HUB**

16" OR 18" WHEEL WHEN LOADED

## FlexDrum Reference Charts

FlexDrums can be mounted on any type of arbor.

### Weights

DIAMETER	WEIGHT
<b>Weight of Hubs*</b>	
4" Diameter Hub	1.5 lbs./inch of width
6" Diameter Hub	2 lbs./inch of width
8" Diameter Hub	2.5 lbs./inch of width
<b>Weight of Hubs with Segments*</b>	
4" Diameter Hub	3.4 - 4 lbs./inch of width
6" Diameter Hub	5 - 5.5 lbs./inch of width
8" Diameter Hub	6.75 - 7 lbs./inch of width

\*Approximate values. Actual weight will depend on abrasive type and overall width of hub.

### FlexDrum Maximum RPM

WHEEL DIAMETER	MAXIMUM RPM
8	4,500
12	3,000
14	2,500
16	2,200
18	2,000

### Recommended H.P. Required

HUB	H.P.
4" Diameter Hub	1/2 H.P. /inch of width
6" Diameter Hub	3/4 H.P./inch of width
8" Diameter Hub	1 H.P./inch of width

### Recommended Surface Feet per Minute for using FlexDrum Wheels on Various Materials

MATERIAL	SFPM
Mild Steel	5,000
Stainless Steel	6,500
Alloy Steel	5,000
Titanium	3,500
Hard Aluminum	5,500
Nonferrous	5,000
Rubber	4,500
Hardwood (edge breaking)	4,000
Softwood	3,500
Thermoplastic	3,000

## SPEC CHECK



### FlexDrum Hub Specification Chart

MODEL NO.	82-B	121-B	141-B	840-B
Diameter of Finished Wheel	8	12	14 or 16	16 or 18
Diameter of Hub Alone	2-3/8	4	6	8
Arbor Hole	1 or 5/8-11 thd	3/4 to 1-3/4	1 to 3-1/2	1-1/4 to 5
Segments Per Hub	12	20	30	40

### How to Determine Diameter of Finished FlexDrums

HUB DIAMETER	TRIM LENGTH (X2)	FINISHED WHEEL
2-3/8	2-3/4	8
4	4	12
4	5	14
6	4	14
6	5	16
8	4	16
8	5	18

## TECH TIP

For surface feet per minute, use the following calculation: SFPM=.262 x DIA (in inches) x RPM.



Made from non-woven synthetic fiber mesh, which is impregnated with abrasives and bound with resins, non-woven wheels are designed to create desired surface finish where little or no stock removal is required. The industry's broadest offering is available for light stock removal, deburring, blending, finishing and polishing. Non-woven wheels have an open mesh construction that is waterproof, washable, conformable and non-loading.

**Applications:**

Cleaning and removing imperfections on metal surfaces, cleaning built-up residue, deburring or finishing a variety of surfaces, blending weld seams or creating decorative finishes. Non-woven surface finishing products have excellent versatility.

**Abrasive Grain:**

Ceramic Alumina, Engineered Aluminum Oxide, Aluminum Oxide, Silicon Carbide

**Grit Range:**

Extra Coarse (XC), Coarse (C), Medium (M), Fine (F)

**Machine Used:**

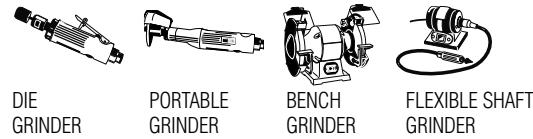

Application/Grit Recommendation Guide

	← MOST AGGRESSIVE		← LEAST AGGRESSIVE →
<b>NORTON</b>	Rapid Strip Wheels	Rapid Blend Unified Wheels	Non-Woven / Interleaf Flap Wheels
Scale Removal	Best Choice		
Painting/Coating Removal	Best Choice		
Stock Removal		Best Choice	
Heavy Deburring		Best Choice	
Polishing			Second Choice
Buffing			Best Choice

Surface Finish Variables

Changes in any one of many factors can affect the surface finish on the workpiece. This chart shows the effect on surface finish by changes in single factors of product specifications. Arrows have been used to signify the trend direction. The arrow length does not signify that the effect of each factor is equal.

Variable Factor	Rough Finish High RMS Reading	Smooth Surface Lower RMS Reading
1. Wheel Speed	Slow ←	→ Fast
2. Feed Speed	Faster (Long Scratch) ←	→ Slower (Short Scratch)
3. Oscillation	No Oscillation ←	→ Oscillation
4. Lubricants	Dry ←	→ Water ←
		→ Soluble Oil ←
		→ Straight Oil
		← Compounds →

Non-Woven Marking System

ABRASIVE	SILICON CARBIDE	ALUMINUM OXIDE		
	← SHARPER, FINER/BRIGHTER SCRATCH PATTERN	→ MORE DURABLE, LONGER LASTING, POLISHED FINISH		
GRIT SIZE	XC (50)	C (60-80)	M (100-150)	F (180-220)
	← FASTER, AGGRESSIVE CUT, ROUGHER FINISH	→ REDUCED CUT RATE, FINER FINISH		
DENSITY	2	9		
	← SOFT, OPEN, CONFORMABLE, LESS BURNING/LOADING	→ HARDER, MORE DURABLE, FASTER CUTTING, BETTER FINISH		

Cross Reference Guide

	STRIPPING	HEAVY/LIGHT DEBURRING	LIGHT DEBURRING/BLENDING/POLISHING	CLEANING/FINISHING	
	<b>BEST</b>	<b>BETTER</b>	<b>BEST</b>	<b>BETTER</b>	<b>GOOD</b>
<b>NORTON</b>	<b>Blaze Rapid Strip</b>	<b>Rapid Strip</b>	<b>Vortex Rapid Blend</b>	<b>Rapid Blend NEX</b>	<b>Non-Woven / Interleaf Flap Wheels</b>
3M	Clean and Strip XT PRO, Clean and Strip XT PRO Extra Cut	Clean Strip	Cut & Polish Unitized, Deburr and Finish PRO	EXL Unitized	Finishing Flap Brush
Standard		Britestrip	800 & 900 Series	500 - 700 Series	Buff & Blend Flap Brush

Rapid Strip Unified Wheels

Best choice for removing rust, scale and paint/coatings on a variety of substrates, such as wood, metal and plastics



**BLAZE RAPID STRIP CERAMIC ALUMINA**

- Norton Blaze ceramic alumina grain provides 2X cut rate, 2X life over silicon carbide products
- Advanced resin bond does not shed on rust-encrusted pieces, and prevents gouging and rework; does not snag when used for deburring
- Leave a thoroughly cleaned surface that ensures excellent adhesion for subsequent processes such as coating, painting and soldering

Better choice for removing coatings on a variety of substrates such as wood metal and plastics



**RAPID STRIP SILICON CARBIDE**

- Faster cutting, sharp, extra coarse silicon carbide abrasive provides a unique combination of aggressive performance, long life, and improved finish
- Advanced resin bond prevents shedding on rust-encrusted pieces and gouging and rework; does not snag when used for deburring
- Leaves a thoroughly clean surface that ensures excellent adhesion in subsequent processes such as coating, painting and soldering



TIER:	BEST	BETTER
TRADENAME:	<b>BLAZE RAPID STRIP</b>	<b>RAPID STRIP</b>
ABRASIVE:	Ceramic Alumina	Silicon Carbide
GRIT:	Extra Coarse	Extra Coarse

SIZE (D x H)	MAX. RPM	STD. PKG.	PART #
<b>Arbor Hole</b>			
4 x 1/4	8,000	25	662610 <b>09324</b>
4 x 1/2	8,000	25	666233 <b>04856</b>
6 x 1/4	4,000	15	666233 <b>40171</b>
6 x 1/2	4,000	15	662610 <b>99378</b>



FITS HOLE	FOR DISC WIDTH	FOR DISC DIAMETER	SHANK DIAMETER	OVERALL LENGTH	WASHER DIAMETER	STD. PKG.	PART #
<b>Mandrel Assemblies For Non-Woven Unified Wheels</b>							
1/4"	1/2" (Standard)	up to 6"	1/4"	2-1/2"	1-1/2"	1	662610 <b>09502</b>
1/2"	1/2" (Standard)	Up to 8"	1/4"	3-1/8"	2-1/4"	1	662610 <b>59420</b>

Rapid Blend Unified Wheels *continued*

Designed for maintenance operations needing an efficient and cost-effective method of deburring, polishing, cleaning or finishing metals and composites. Easily preformed for use on a wide variety of shapes/contours. Hold shape well; less wheel dressing. Non-metallic so no contamination of workpiece. Uniform construction maintains part tolerance; prevents cutting or gouging.



Best choice for light weld bead and weld spatter removal, heavy deburring and finishing applications

VORTEX RAPID BLEND ALUMINUM OXIDE

- High-performance, medium grit, engineered aluminum oxide grain and improved resin bond system provide aggressive, fast, stock removal, reduced cycle times, and excellent part quality
- Thick nylon web delivers 2X longer life and faster finishing – with minimal shedding vs competitive wheels
- Controlled porosity ensures cool cutting and improved cut rate

TIER: **BEST**  
TRADENAME: **VORTEX RAPID BLEND**  
ABRASIVE: Aluminum Oxide

SIZE (D x T x H)	GRIT SIZE	STD. PKG.	MAX. RPM	3 DENSITY PART #	MAX. RPM	5 DENSITY PART #	MAX. RPM	7 DENSITY PART #	MAX. RPM	9 DENSITY PART #
2 x 1/8 x 1/8	M	60			22,000	662544 <b>25657</b>	20,000	662544 <b>10849</b>		
2 x 1/8 x 1/4	M	60					22,000	66261 <b>191446</b>		
2 x 1/4 x 1/4	M	60	18,000	662544 <b>28456</b>	22,000	662544 <b>33504</b>	22,000	662610 <b>80270</b>		
2 x 1 x 1/4	M	15					22,000	662610 <b>80269</b>		
3 x 1/8 x 1/4	M	40			18,000	662610 <b>93448</b>	18,000	662611 <b>91445</b>		
3 x 1/8 x 3/8	M	40			18,000	662544 <b>33503</b>	18,000	662544 <b>01131</b>		
3 x 1/4 x 1/4	M	40	12,000	662544 <b>28454</b>	18,000	662544 <b>14832</b>	18,000	662611 <b>99696</b>		
3 x 1/4 x 3/8	M	40	12,000	662544 <b>33505</b>	12,000	662544 <b>33506</b>				
3 x 1/2 x 1/4	M	20			18,000	662544 <b>32925</b>	18,000	662610 <b>80267</b>	18,000	662544 <b>33507</b>
3 x 1/2 x 3/8	M	20			18,000	662544 <b>33508</b>	18,000	662610 <b>80266</b>	18,000	662544 <b>20696</b>



Better choice for light deburring and blending

RAPID BLEND NEX ALUMINUM OXIDE AND SILICON CARBIDE

- Uniform construction provides extra long life and holds shape well for less wheel dressing
- Smear free resin binder formula provides smear-free finishes
- A great option for light deburring and blending applications

TIER: **BETTER**  
TRADENAME: **RAPID BLEND NEX**

SIZE (D x T x H)	ABRASIVE	GRIT	MAX. RPM	STD. PKG.	2 DENSITY PART #	3 DENSITY PART #	4 DENSITY PART #	6 DENSITY PART #	8 DENSITY PART #
1 x 1 x 3/16	A/O	C	30,000	50					662610 <b>14915</b>
	A/O	M	18,000	50	662610 <b>14891</b>				
	A/O	M	30,000	50				662610 <b>14908</b>	662610 <b>14924</b>
	S/C	F	18,000	50	662610 <b>14883</b>				
	S/C	F	30,000	50				662610 <b>14904</b>	662610 <b>14923</b>
2 x 1/8 x 1/4	A/O	M	22,000	60					662610 <b>14927</b>
2 x 1/4 x 1/4	A/O	M	18,000	60	662610 <b>14892</b>				
	A/O	M	22,000	60					662610 <b>14926</b>
	A/O	F	22,000	60				662610 <b>14901</b>	
	S/C	F	18,000	60	662610 <b>14884</b>				
2 x 1/2 x 1/4	A/O	M	22,000	30					662610 <b>14925</b>
3 x 1/4 x 1/4	A/O	C	18,000	40					662610 <b>14919</b>
	A/O	M	18,000	40				662610 <b>14909</b>	662610 <b>14930</b>
	S/C	F	12,000	40	662610 <b>14886</b>				
3 x 1/4 x 3/8	A/O	C	18,000	40					662610 <b>14920</b>
	A/O	M	12,000	40	662610 <b>14895</b>				
	A/O	M	18,000	40				662610 <b>14910</b>	662610 <b>14933</b>
	A/O	F	12,000	40			662610 <b>14899</b>		
	S/C	F	12,000	40	662610 <b>14887</b>	662610 <b>16006</b>			
3 x 1/2 x 1/4	A/O	M	12,000	20	662610 <b>14893</b>				
	A/O	M	18,000	20				662610 <b>14928</b>	
	S/C	F	12,000	20	662610 <b>14885</b>				
3 x 1/2 x 3/8	A/O	M	18,000	20					662610 <b>14929</b>
3 x 1 x 3/8	S/C	XC	18,000	10				662610 <b>14914</b>	
6 x 1/2 x 1	A/O	M	7,500	4					662610 <b>14931</b>
6 x 1 x 1	S/C	F	5,000	2	662610 <b>14888</b>				

Assemblies and Mandrels for Unified Wheels

FITS WHEEL CENTER HOLE	FOR WHEEL WIDTH	FOR WHEEL DIAMETER	SHANK DIAMETER	OVERALL LENGTH	WASHER DIAMETER	3M EQUIVALENT	STD. PKG.	PART #
<b>Mandrel Assemblies for Unified Wheels and Discs On Edge</b>								
3/16	1/8 – 1/2	1 – 2	1/4	2	7/16	994	1	662610 <b>09852</b>
1/4 – 5/16	Up to 1/2	Up to 2	1/4	2	5/8	932	1	662610 <b>15146</b>
1/4 – 5/16	Up to 1	Up to 2	1/4	2-1/2	5/8	932	1	662610 <b>59422</b>
	Up to 1	2 – 3	1/4	2-1/2	1	933	1	662610 <b>59421</b>
3/8	Up to 1/2	2 – 4	1/4	2-1/2	1	990	1	662610 <b>09851</b>
1/2	Up to 1	3 – 6	1/4	3-1/8	1-5/8	934	1	662610 <b>09850</b>
FOR CENTER HOLE	USE WITH UNIFIED WHEEL	SHANK DIAMETER	SHANK LENGTH			3M EQUIVALENT	STD. PKG.	PART #
<b>Threaded Mandrel for Unified Wheels</b>								
3/16	1 x 1 x 3/16	1/4"	1-3/4"			948	5	662610 <b>47584</b>



MANDREL ASSEMBLY 662610**59421**



THREADED MANDREL 662610**47584**



MANDREL ASSEMBLY 662610**59422**





**NEW**

Used in a multitude of operations in almost every industry and on a variety of machines, mounted points are small grinding wheels permanently fastened to its own spindle. These vitrified bond mounted points are available in a wide range of shapes.

**Industries:**

- |                   |                           |
|-------------------|---------------------------|
| Aerospace         | Cutlery                   |
| Tool and Die      | Mold Shops                |
| Construction      | Stainless Steel Equipment |
| Metal Fabrication | Foundries                 |
| Automotive        |                           |

**Abrasive Grain:**

Aluminum Oxide

**Shape Availability:**

A, B, and W

**Machine Used:**

- |   |  |
|---|--|
|  |  |
| DIE AND PENCIL GRINDER  | HORIZONTAL/STRAIGHT SHAFT PORTABLE GRINDER   |

**Measurement Guide**

**Description of Overhang**

Overhang is the distance between the grinder chuck and the abrasive on the spindle. The larger the overhang, the lower the maximum safe operating speed.

**Size**

Measured by diameter (D) x thickness (T)

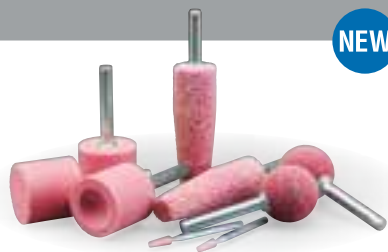
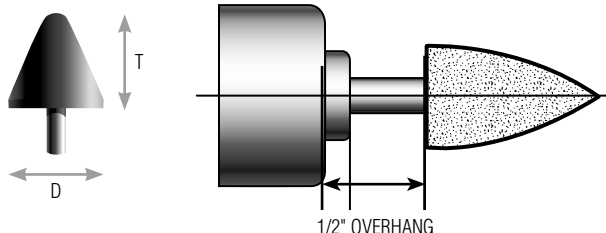

**NEW**

Better medium grit option for blending and deburring

**PINK ALUMINUM OXIDE – VITRIFIED BOND**

- Sharp versatile 86A aluminum oxide grain is free cutting and resists burn
- Excellent form holding compared to more friable white aluminum oxides
- Medium grit for blending and deburring

TIER: **BETTER**  
TRADENAME: **PINK**  
ABRASIVE: 86A Aluminum Oxide

SHAPE	SIZE (D x T)	SPINDLE DIA. †	MAX. RPM*	MIN./STD. PKG.	SPEC	PART #
<b>Vitrified Bond Mounted Points – A Shapes</b>						
A1	3/4 x 2-1/2	1/4	19,800	5/25	86A80-S	690786 <b>45335</b>
A3	1 x 2-3/4	1/4	16,100	5/25	86A80-S	690786 <b>45333</b>
A5	3/4 x 1-1/8	1/4	45,000	5/25	86A80-S	690786 <b>45339</b>
A11	7/8 x 2	1/4	19,860	5/25	86A80-S	690786 <b>45336</b>
A12	11/16 x 1-1/4	1/4	48,000	5/25	86A80-S	690786 <b>45344</b>
A25	1" Ball	1/4	35,620	5/25	86A80-S	690786 <b>45341</b>
A38	1 x 1	1/4	34,500	5/25	86A80-S	690786 <b>45345</b>
<b>Vitrified Bond Mounted Points – B Shapes</b>						
B52	3/8 x 3/4	1/8	45,370	5/25	86A80-S	690786 <b>45334</b>
B53	5/16 x 5/8	1/8	60,000	5/25	86A80-S	690786 <b>45340</b>
B81	3/4 x 3/16	1/8	50,930	5/25	86A80-S	690786 <b>45347</b>
B97	1/8 x 3/8	1/8	105,000	5/25	86A80-S	690786 <b>45337</b>
B121	1/2" Ball	1/8	45,370	5/25	86A80-S	690786 <b>45338</b>
B122	3/8" Ball	1/8	61,650	5/25	86A80-S	690786 <b>45360</b>
B135	1/4 x 1/2	1/8	60,000	5/25	86A80-S	690786 <b>45342</b>
<b>Vitrified Bond Mounted Points – W Shapes</b>						
W163	1/4 x 1/2	1/8	60,000	5/25	86A80-S	690786 <b>45346</b>
W177	3/8 x 3/4	1/8	33,750	5/25	86A80-S	690786 <b>45355</b>
W185	1/2 x 1/2	1/4	61,500	5/25	86A80-S	690786 <b>45354</b>
W200	3/4 x 1/8	1/8	50,930	5/25	86A80-S	690786 <b>45356</b>
W220	1 x 1	1/4	25,500	5/25	86A80-S	690786 <b>45359</b>
W235	1-1/2 x 1/4	1/4	25,470	5/25	86A80-S	690786 <b>45343</b>

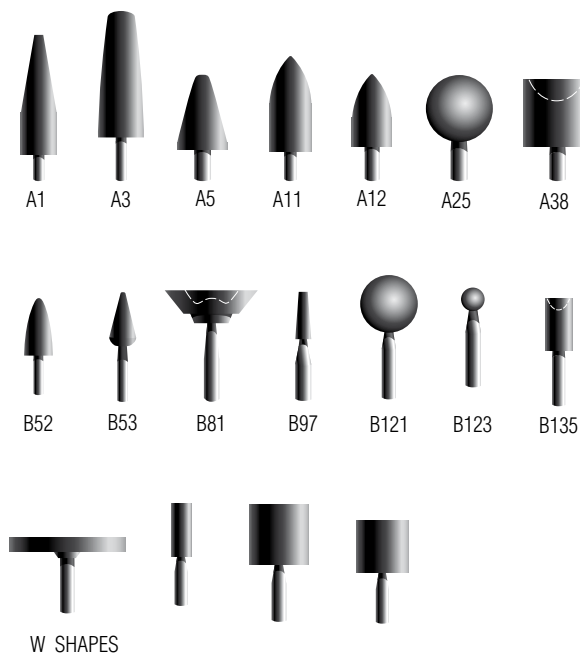

† Standard spindle size is 1/4" x 1-1/2"  
\* Maximum RPM valid to 1/2" overhang. See package insert for other overhangs.

Refer to the Precision Offhand/Portable section for the full offering of mounted points.





**NEW**

Our double-cut style carbide burrs have stronger tooth formulation and numerous cutting edges to outperform other double-cut carbide burrs with better stock removal, granular chip break, and longer life.

Pair up these long-lasting burrs with our pneumatic die grinder to quickly and comfortably accomplish many portable applications on one machine – including jobs using specialties, small diameter flap wheels, and mounted points.

**Applications:** Deburring, medium-to-light surface cleaning and stock removal, weld removal and prep, chamfering

**Shapes:** A, B, C, D, E, F, G, H, L, M

**Shank Diameter:** 1/4"

**Machine Used:**



DIE GRINDER

## Understanding the Product

### Burr Dimensions

D1	L1	D2	L2
HEAD DIAMETER	HEAD LENGTH	SHANK DIAMETER	OVERALL BURR LENGTH (OL)

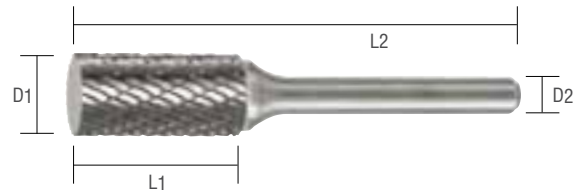

## TECH TIP

Each carbide burr is packed individually in a clear, protective plastic case with Norton-blue end-caps. Each burr is marked with the burr head diameter and length for easy identification.

## Carbide Burrs Merchandising Display

For those last minute point-of-purchase sales the Carbide Burr merchandiser is an ideal addition to any counter or display shelf. Holds twenty-four burrs in the lockable front display with plenty of storage in the back drawer.



MERCHANDISING DISPLAY

SUB-SHAPE	D	W	H	MIN/STD PKG QTY	PART #
Carbide Burr Merchandising Display	15-1/4"	9-1/4"	16"	1	699573 <b>66825</b>



DISPLAY HEADER CARD



DISPLAY BACKER DECAL

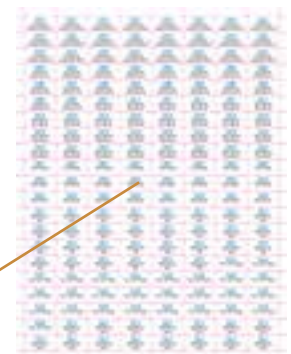

DISPLAY PRODUCT DECALS

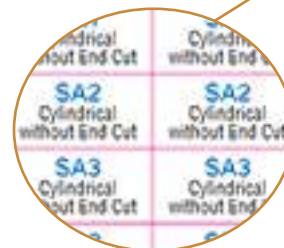



Double cut burrs are a popular choice because of their universal cutting style

## DOUBLE CUT CARBIDE BURRS

- Hard tungsten carbide burrs with strong tooth formulations and numerous cutting edges for extended life and less changeover downtime versus other cutting tools
- Higher stock removal, and smaller, granular chip-break on hard-to-grind workpieces versus other carbide burrs
- Perform well at higher temperatures and can be used longer than high-speed steel tools – even if your operation generates some heat

### Carbide Burrs for Standard Metal Removal



#### SA Cylindrical without End Cut

The ends of these burrs are flat, with no cutting edges and are used for contour finishing and to get into right-angled corners.

SUB-SHAPE	MAX. RPM	D1	L1	L2	MIN/STD PKG QTY	PART #
SA1	25,000	1/4"	3/4"	2"	1	699573 <b>08002</b>
SA2	25,000	5/16"	3/4"	2-1/2"	1	699573 <b>08003</b>
SA3	25,000	3/8"	3/4"	2-1/2"	1	699573 <b>08004</b>
SA5	25,000	1/2"	1"	2-3/4"	1	699573 <b>08005</b>
SA5	25,000	1/2"	1"	6"	1	699573 <b>60674</b>



#### SB Cylindrical with End Cut

The cutting edge at the end of the burr makes these burrs a good choice for contour finishing.

SUB-SHAPE	MAX. RPM	D1	L1	L2	MIN/STD PKG QTY	PART #
SB3	25,000	3/8"	3/4"	2-1/2"	1	699573 <b>08006</b>
SB3	25,000	3/8"	3/4"	6"	1	699573 <b>40156</b>
SB5	25,000	1/2"	1"	2-3/4"	1	699573 <b>08007</b>
SB5	25,000	1/2"	1"	6"	1	699573 <b>40157</b>
SB6	25,000	5/8"	1"	2-3/4"	1	699573 <b>08008</b>



#### SC Ball-Nosed Cylindrical

Use these round-nosed burrs for smoother operation and better tool control.

SUB-SHAPE	MAX. RPM	D1	L1	L2	MIN/STD PKG QTY	PART #
SC1	25,000	1/4"	3/4"	2"	1	699573 <b>08009</b>
SC2	25,000	5/16"	3/4"	2-1/2"	1	699573 <b>08010</b>
SC3	25,000	3/8"	3/4"	2-1/2"	1	699573 <b>08011</b>
SC3	25,000	3/8"	3/4"	6"	1	699573 <b>60678</b>
SC5	25,000	1/2"	1"	2-3/4"	1	699573 <b>08012</b>
SC5	25,000	1/2"	1"	6"	1	699573 <b>60679</b>
SC5	25,000	1/2"	1"	12"	1	699573 <b>60905</b>
SC6	25,000	5/8"	1"	2-3/4"	1	699573 <b>08013</b>



#### SD Ball Shape

Use these carbide burrs to create a concave and to hollow out a workpiece.

SUB-SHAPE	MAX. RPM	D1	L1	L2	MIN/STD PKG QTY	PART #
SD1	25,000	1/4"	1/4"	2"	1	699573 <b>08014</b>
SD2	25,000	5/16"	1/4"	2"	1	699573 <b>08015</b>
SD3	25,000	3/8"	5/16"	2-1/8"	1	699573 <b>08016</b>
SD5	25,000	1/2"	7/16"	2-3/16"	1	699573 <b>08017</b>
SD5	25,000	1/2"	7/16"	6"	1	699573 <b>60686</b>
SD9	25,000	1"	15/16"	2-15/16"	1	699573 <b>60865</b>

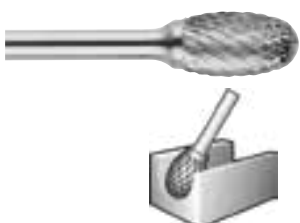

#### SE Oval Shape

Use the oval-shaped carbide burrs for good reach and round head for shaping.

SUB-SHAPE	MAX. RPM	D1	L1	L2	MIN/STD PKG QTY	PART #
SE3	25,000	3/8"	5/8"	6"	1	699573 <b>40158</b>
SE5	25,000	1/2"	7/8"	6"	1	699573 <b>40159</b>

Carbide Burrs for Standard Metal Removal

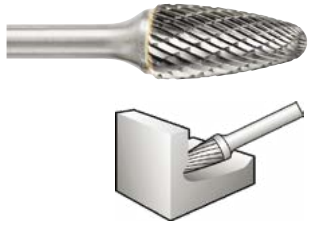

**SF** Ball-Nosed Tree  
Designed to round off edges and make concave cuts.

SUB-SHAPE	MAX.-RPM	D1	L1	L2	MIN/STD PKG QTY	PART #
SF1	25,000	1/4"	3/4"	2"	1	699573 <b>08018</b>
SF2	25,000	5/16"	3/4"	2-1/2"	1	699573 <b>08019</b>
SF3	25,000	3/8"	3/4"	2-1/2"	1	699573 <b>08020</b>
SF3	25,000	3/8"	3/4"	6"	1	699573 <b>60689</b>
SF5	25,000	1/2"	1"	2-3/4"	1	699573 <b>08021</b>
SF5	25,000	1/2"	1"	6"	1	699573 <b>60691</b>
SF5	25,000	1/2"	1"	12"	1	699573 <b>60904</b>
SF6	25,000	5/8"	1"	2-3/4"	1	699573 <b>08022</b>



**SG** Tree with Taper  
The taper allows access to hard-to-reach areas, such as angled contours.

SUB-SHAPE	MAX.-RPM	D1	L1	L2	MIN/STD PKG QTY	PART #
SG1	25,000	1/4"	3/4"	2"	1	699573 <b>08023</b>
SG2	25,000	5/16"	3/4"	2-1/2"	1	699573 <b>08024</b>
SG3	25,000	3/8"	3/4"	2-1/2"	1	699573 <b>08025</b>
SG5	25,000	1/2"	1"	2-3/4"	1	699573 <b>08026</b>
SG5	25,000	1/2"	1"	6"	1	699573 <b>60712</b>
SG6	25,000	5/8"	1"	2-3/4"	1	699573 <b>08027</b>
SG13	25,000	3/4"	1-1/2"	3/4"	1	699573 <b>66821</b>
SG15	25,000	3/4"	1-1/2"	1/4"	1	699573 <b>60886</b>

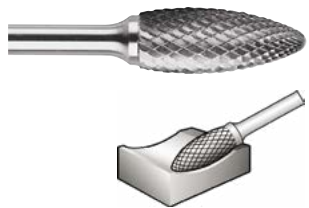

**SH** Flame Shape  
Great for channel working and shaping due to its long fluted sides and rounded head.

SUB-SHAPE	MAX.-RPM	D1	L1	L2	MIN/STD PKG QTY	PART #
SH5	25,000	1/2"	1-1/4"	6"	1	699573 <b>66822</b>



**SL** Ball-Nosed Cone  
This cone shape is excellent for imparting fine finishes.

SUB-SHAPE	MAX.-RPM	D1	L1	L2	MIN/STD PKG QTY	PART #
SL2	25,000	5/16"	7/8"	2-3/4"	1	699573 <b>08028</b>
SL3	25,000	3/8"	1 3/16"	2-15/16"	1	699573 <b>08029</b>
SL3	25,000	3/8"	1-1/16"	6"	1	699573 <b>60716</b>
SL4	25,000	1/2"	1 3/16"	3"	1	699573 <b>08030</b>
SL4	25,000	1/2"	1-3/16"	6"	1	699573 <b>60720</b>
SL5	25,000	1/2"	1"	6"	1	699573 <b>66823</b>



**SM** Pointed Cone  
Ideal for rounded edges or reaching difficult, tight areas.

SUB-SHAPE	MAX.-RPM	D1	L1	L2	MIN/STD PKG QTY	PART #
SM4	25,000	3/8"	5/8"	6"	1	699573 <b>66824</b>
SM5	25,000	1/2"	7/8"	6"	1	699573 <b>60767</b>

Carbide Burr Kit



SUB-SHAPE	MIN/STD PKG QTY	PART #
Carbide Burr Kit*	1	699573 <b>08060</b>

\* Kit Includes one each of: SA5 (699573**08005**), SF3 (699573**08020**), SF5 (699573**08021**), SG5 (699573**08026**), and SL4 (699573**08030**)

Carbide Burrs for Aluminum and Non-Ferrous Materials

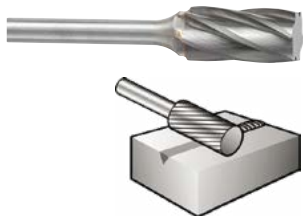

**SA** Cylindrical without End Cut

The ends of these burrs are flat, with no cutting edges and are used for contour finishing and to get into right-angled corners.

SUB-SHAPE	MAX. RPM	D1	L1	L2	MIN/STD PKG QTY	PART #
SA3 NF	25,000	3/8"	3/4"	2-1/2"	1	699573 <b>40148</b>
SA5 NF	25,000	1/2"	1"	2-3/4"	1	699573 <b>40149</b>

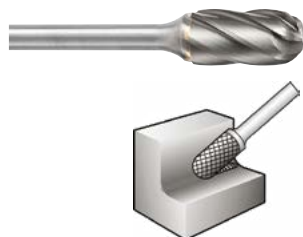

**SC** Ball-Nosed Cylindrical

Use these round-nosed burrs for smoother operation and better tool control.

SUB-SHAPE	MAX. RPM	D1	L1	L2	MIN/STD PKG QTY	PART #
SC3 NF	25,000	3/8"	3/4"	2-3/4"	1	699573 <b>40150</b>
SC5 NF	25,000	1/2"	1"	6"	1	699573 <b>60657</b>

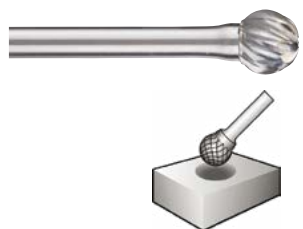

**SD** Ball Shape

Use these carbide burrs to create a concave and to hollow out a workpiece.

SUB-SHAPE	MAX. RPM	D1	L1	L2	MIN/STD PKG QTY	PART #
SD3 NF	25,000	3/8"	5/16"	2-1/8"	1	699573 <b>66820</b>
SD5 NF	25,000	1/2"	7/16"	2-3/16"	1	699573 <b>40152</b>

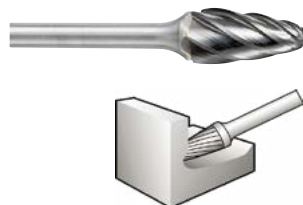

**SF** Ball-Nosed Tree

Designed to round off edges and make concave cuts.

SUB-SHAPE	MAX. RPM	D1	L1	L2	MIN/STD PKG QTY	PART #
SF1 NF	25,000	1/4"	3/4"	2"	1	699573 <b>40153</b>
SF3 NF	25,000	3/8"	3/4"	2-1/2"	1	699573 <b>40154</b>
SF5 NF	25,000	1/2"	1"	2-3/4"	1	699573 <b>60647</b>



**SG** Tree with Taper

The taper allows access to hard-to-reach areas, such as angled contours.

SUB-SHAPE	MAX. RPM	D1	L1	L2	MIN/STD PKG QTY	PART #
SG5 NF	25,000	1/2"	1"	2-3/4"	1	699573 <b>60646</b>

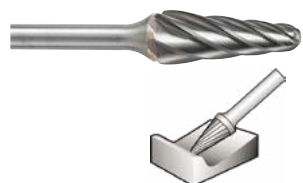

**SL** Ball-Nosed Cone

This cone shape is excellent for imparting fine finishes.

SUB-SHAPE	MAX. RPM	D1	L1	L2	MIN/STD PKG QTY	PART #
SL4 NF	25,000	1/2"	1-1/4"	6"	1	699573 <b>60651</b>

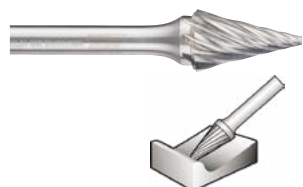

**SM** Pointed Cone

Ideal for rounded edges or reaching difficult, tight areas.

SUB-SHAPE	MAX. RPM	D1	L1	L2	MIN/STD PKG QTY	PART #
SM3 NF	25,000	1/2"	7/8"	2"	1	699573 <b>40155</b>

we've got you covered  
**FROM DIY TO TOOLCRIB  
TO PRODUCTION FLOOR**

Available in vitrified bond, resin bond, center lap and cotton fiber, and in a variety of shapes our mounted points offer fast, free cutting grinding and finishing capability. Produce sharp edges with the Norton line of sharpening stones - bringing solutions for craftsmen and hobbyists alike for over 190 years.

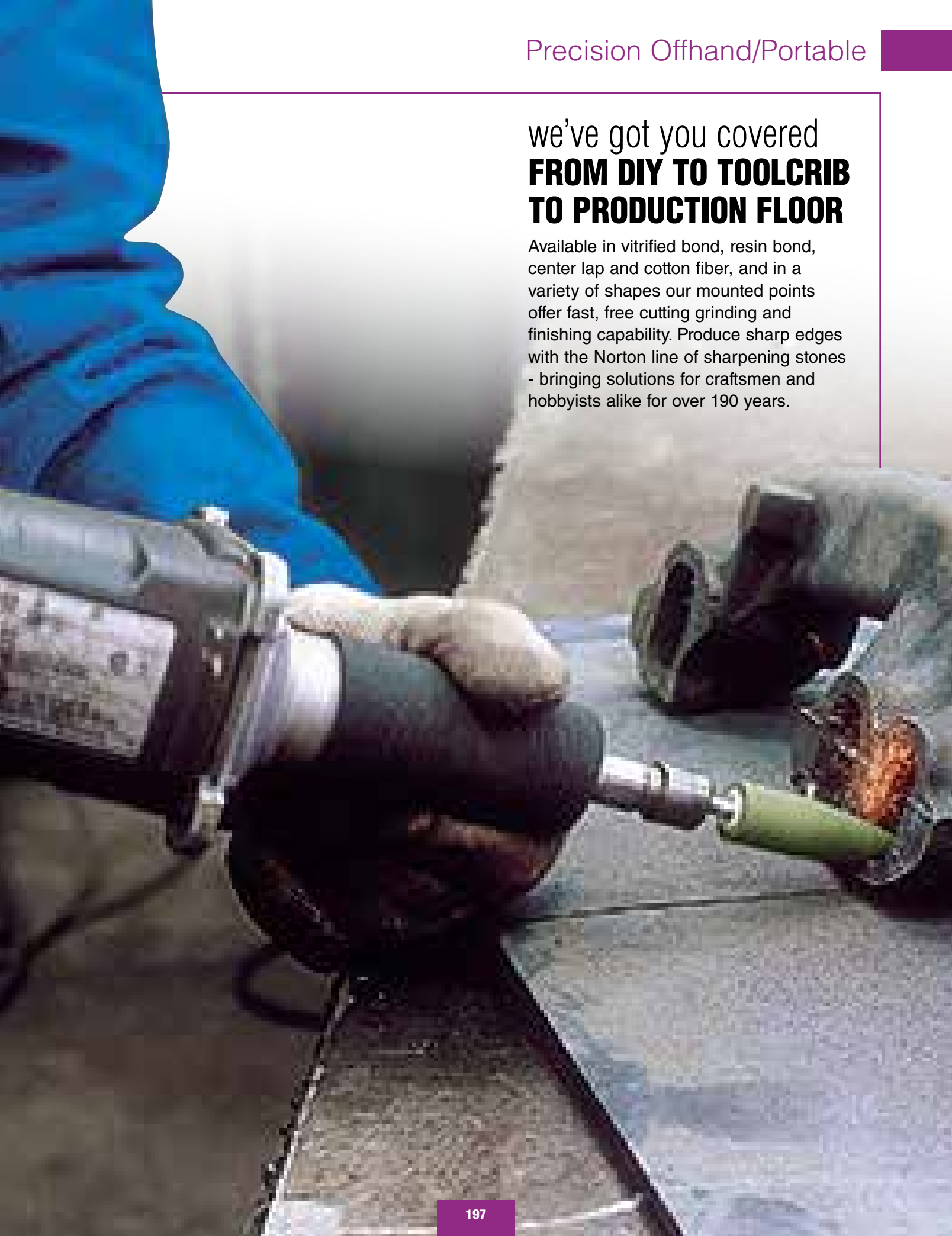



Resin bond, vitrified bond, center lap, and cotton fiber mounted points are available in a wide range of shapes.

- Industries:**
- Aerospace
  - Tool and Die
  - Construction
  - Metal Fabrication
  - Automotive
  - Cutlery
  - Mold Shops
  - Stainless Steel Equipment
  - Foundries

**Abrasive Grain:** Ceramic Alumina, Zirconia Alumina, Zirconia Alumina / Aluminum Oxide Blend, Aluminum Oxide

**Shape Availability:** A, B, and W

**Machine Used:**



DIE AND  
PENCIL  
GRINDER



HORIZONTAL/  
STRAIGHT SHAFT  
PORTABLE GRINDER

### Measurement Guide

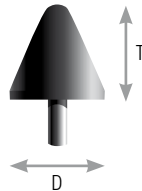
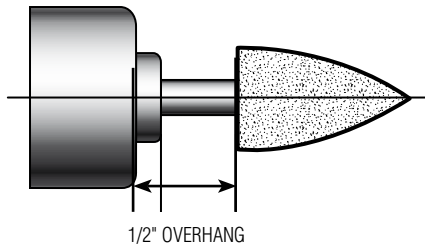

#### Description of Overhang

Overhang is the distance between the grinder chuck and the abrasive on the spindle. The larger the overhang, the lower the maximum safe operating speed.

#### Size

Measured by diameter (D) x thickness (T)

### Cotton Fiber



Good for blending and polishing

## COTTON FIBER ALUMINUM OXIDE - RESIN BOND

- Aluminum oxide grain provides an excellent blend of cut rate and life
- The cotton fibers ensure smooth, chatter-free grinding
- Designed for blending and polishing in one step; use 80 grit for most materials and 120 for polishing and stainless steel applications

TIER: **GOOD**  
TRADENAME: **COTTON FIBER**  
ABRASIVE: Aluminum Oxide

SHAPE	SIZE (D x T)	SPINDLE DIA. †	MAX. RPM*	MIN./STD. PKG.	SPEC	PART #
<b>Cotton Fiber Mounted Points</b>						
A11	7/8 x 2	1/4	19,860	5/25	A80-HBF3	614636 <b>22664</b>
B52	3/8 x 3/4	1/8	45,370	5/25	A120-HBF3	614636 <b>20242</b>
B121	1/2" Ball	1/8	45,370	5/25	A80-HBF3	614636 <b>22657</b>
W163	1/4 x 1/2	1/8	60,000	5/25	A80-HBF3	614636 <b>22655</b>
			60,000	5/25	A120-HBF3	614636 <b>22656</b>
W176	3/8 x 1/2	1/8	45,370	5/25	A80-HBF3	614636 <b>22654</b>
W185	1/2 x 1/2	1/8	34,500	5/25	A80-HBF3	614636 <b>22649</b>
W187	1/2 x 1	1/8	20,620	5/25	A80-HBF3	614636 <b>22651</b>
W220	1 x 1	1/4	25,500	5/25	A80-HBF3	614636 <b>22646</b>

† Spindle length is 1-1/2"

\* Maximum RPM valid to 1/2" overhang. See package insert for other overhangs.

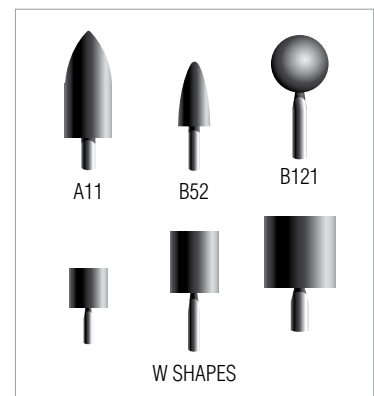

### Center Lap

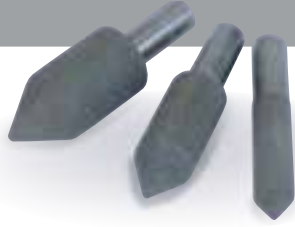

Better for Excell-O center lap and similar machines

## CENTER LAP ALUMINUM OXIDE - VITRIFIED BOND

- Specially formulated wheel treatment provides added lubricity to the wheel, minimizing risk of metallurgical damage
- The larger diameter spindle ensures minimal deflection and rigid support
- Precise dimensional tolerances ensure accurate location of part centers

TIER: **BETTER**  
 TRADENAME: **CENTER LAP**  
 ABRASIVE: Aluminum Oxide

SHAPE	SIZE (D x T)	SPINDLE DIA. †	MAX. RPM*	MIN./STD. PKG.	SPEC	PART #
<b>Center Lap Mounted Points</b>						
–	1/2 x 2**	1/2	65,000	5/25	A80-VVM	614636 <b>21421</b>
–	1 x 2**	1/2	15,900	5/25	A80-VVM	614636 <b>22926</b>

† Spindle length is 1-1/4"

\* Maximum RPM valid to 1/2" overhang. See package insert for other overhangs.

\*\* Pointed 60°

### TECH TIP

Dress the center lap mounted points frequently to ensure accurate and smooth center holes.



It is the user's responsibility to refer to and comply with ANSI B7.1

### Resin Bond



Best choice for fast stock removal

## NORZON ZIRCONIA ALUMINA – RESIN BOND

- Zirconia alumina abrasive blend for 2X faster cut rate than standard aluminum oxide
- Strong grain and specially formulated organic bond provide 4X greater life than aluminum oxide points, while reducing vibration and wheel chatter
- Ideal for removing parting lines, fins and small risers from castings, and smoothing and blending of welded areas



Better choice for fast stock removal and long life

## CHARGER Z/A & A/O BLEND – RESIN BOND

- Durable zirconia alumina and aluminum oxide abrasive blend delivers 35% faster cut rate than standard aluminum oxide; an aggressive, free cut, and more parts cleaned in less time to substantially increase productivity
- Specially formulated organic bond provides 2X greater life than standard resin bonds while reducing vibration and wheel chatter
- Better choice for removing parting lines, fins and small risers from castings, and smoothing and blending welded areas
- Charger mounted point pre-packed in small packages are ideal for vending machines, pegboards, small jobs, and carrying to job site

TIER: **BEST** | **BETTER**  
 TRADENAME: **NORZON** | **CHARGER**  
 ABRASIVE: Zirconia Alumina | Zirconia Alumina/Aluminum Oxide

SHAPE	SIZE (D x T)	SPINDLE DIA. †	MAX. RPM*	MIN./STD. PKG.	SPEC	PART #	SPEC	PART #
<b>Resin Bond Mounted Points</b>								
A1	3/4 x 2-1/2	1/4	19,800	5/25	NZ24-UBXR1	614636 <b>16457</b>	Charger	614636 <b>16458</b>
A3	1 x 2-3/4	1/4	16,100	5/25	NZ24-UBXR1	614636 <b>16459</b>	Charger	614636 <b>16460</b>
A5	3/4 x 1-1/8	1/4	45,000	5/25			Charger	614636 <b>16462</b>
A11	7/8 x 2	1/4	19,860	5/25	NZ24-UBXR1	614636 <b>16463</b>	Charger	614636 <b>16464</b>
W189	1/2 x 2	1/4	24,000	5/25	NZ24-UBXR1	614636 <b>16465</b>	Charger	614636 <b>16466</b>
W197	5/8 x 2	1/4	21,000	5/25	NZ24-UBXR1	614636 <b>16467</b>		
W207	3/4 x 1-1/2	1/4	24,000	5/25			Charger	614636 <b>16470</b>
W208	3/4 x 2	1/4	18,750	5/25	NZ24-UBXR1	614636 <b>16471</b>	Charger	614636 <b>16472</b>
W220	1 x 1	1/4	25,500	5/25	NZ24-UBXR1	614636 <b>17520</b>	Charger	614636 <b>17521</b>
			25,500	5 V			Charger	662533 <b>25930</b>
W221	1 x 1-1/2	1/4	19,120	5/25	NZ24-UBXR1	614636 <b>16473</b>	Charger	614636 <b>16474</b>
W222	1 x 2	1/4	15,900	5/25	NZ24-UBXR1	614636 <b>16475</b>	Charger	614636 <b>16476</b>

† Spindle length is 1-1/2"

\* Maximum RPM valid to 1/2" overhang. See package insert for other overhangs.

V = Vendible package. Ideal for vending machines and small jobs. Min. Pkg. Qty = number of mounted points per vendible pack. Order in multiples of min qty.

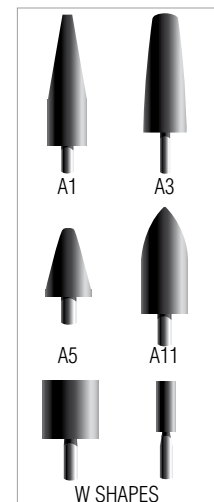

Vitrified Bond

Best choice for high volume operations



QUANTUM CERAMIC ALUMINA – VITRIFIED BOND

- Quantum grain with unique, engineered ceramic grain and shape, specifically developed for high-volume, high-speed alloy grinding operations
- Minimal loading and heat build-up; provide up to 33% longer life and 37% better metal removal rates versus other ceramic points
- Versatile; optimized for all low-, medium-, and high-force vitrified applications
- Oil and Gas 36 grit mounted points; specifically engineered to efficiently grind the carbide matrix material of oil field drill heads

Better medium grit option for blending and deburring

NEW

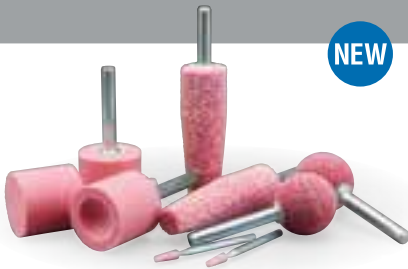

PINK ALUMINUM OXIDE – VITRIFIED BOND

- Sharp versatile 86A aluminum oxide grain is free cutting and resists burn
- Excellent form holding compared to more friable white aluminum oxides
- Medium grit for blending and deburring

Good value for general purpose, small job shop applications



GEMINI ALUMINUM OXIDE – VITRIFIED BOND

- 38A abrasive is designed to be cool cutting to minimize burn
- High temperature vitrified bond maximizes form holding and life
- Wide grit range for stock removal, blending/deburring, and finishing/polishing

TECH TIP

- For best mounted point performance, always run the mounted point at the maximum allowable speed according to ANSI B7.1. Refer to the speed chart included in each shipment for proper operating speeds.
- Use "A" shapes for medium- to heavy-duty blending.
- Use "B" shapes for light deburring and finishing/polishing.
- Use "W" shapes for offhand and precision grinding of medium to heavy stock.
- Use 36 grit and coarser for rough grinding.
- Use 60 and 90 grits for imparting fine finishes or when grinding on narrow surfaces.



It is the user's responsibility to refer to and comply with ANSI B7.1





Vitrified Bond

TIER:	<b>BEST</b>	BETTER	<b>NEW</b>	GOOD
TRADENAME:	<b>QUANTUM</b>	<b>PINK</b>		<b>GEMINI</b>
ABRASIVE:	Ceramic Alumina	86A Aluminum Oxide		38A Aluminum Oxide

SHAPE	SIZE (D x T)	SPINDLE DIA. †	MAX. RPM*	MIN./STD. PKG.	SPEC	PART #	SPEC	PART #	SPEC	PART #
<b>Vitrified Bond Mounted Points – A Shapes</b>										
A1	3/4 x 2-1/2	1/4	19,800	25/250	Oil & Gas 36	614636 <b>86139</b>				
A1	3/4 x 2-1/2	1/4	19,800	5/25	3NQ80	690831 <b>49139</b>	86A80-S	690786 <b>45335</b>	38A36-T	614636 <b>24374</b>
A1	3/4 x 2-1/2	1/4	19,800	5/25					38A60-P	614636 <b>24375</b>
A3	1 x 2-3/4	1/4	16,100	25/250	Oil & Gas 36	614636 <b>86138</b>				
A3	1 x 2-3/4	1/4	16,100	5/25			86A80-S	690786 <b>45333</b>	38A36-T	614636 <b>24377</b>
A3	1 x 2-3/4	1/4	16,100	5/25					38A60-P	614636 <b>24378</b>
A4	1-1/4 x 1-1/4	1/4	30,560	5/25					38A60-P	614636 <b>24380</b>
A5	3/4 x 1-1/8	1/4	45,000	5/25			86A80-S	690786 <b>45339</b>	38A36-T	614636 <b>24381</b>
A5	3/4 x 1-1/8	1/4	45,000	5/25					38A60-P	614636 <b>24382</b>
A11	7/8 x 2	1/4	19,860	5/25	3NQ80	690831 <b>49141</b>			38A36-T	614636 <b>24384</b>
A11	7/8 x 2	1/4	19,860	5/25			86A80-S	690786 <b>45336</b>	38A60-P	614636 <b>24385</b>
A12	11/16 x 1-1/4	1/4	48,000	5/25			86A80-S	690786 <b>45344</b>	38A60-P	614636 <b>24388</b>
A13	1-1/8 x 1-1/8	1/4	33,950	5/25					38A60-P	614636 <b>24389</b>
A15	1/4 x 1-1/16	1/4	72,750	5/25					38A60-P	614636 <b>24391</b>
A21	1 x 1	1/4	34,500	5/25					38A60-P	614636 <b>24392</b>
A23	3/4 x 1	1/4	39,370	5/25					38A60-P	614636 <b>24394</b>
A24	1/4 x 3/4	1/4	76,500	5/25					38A60-P	614636 <b>24395</b>
A25	1" Ball	1/4	35,620	5/25			86A80-S	690786 <b>45341</b>	38A60-P	614636 <b>24396</b>
A26	5/8" Ball	1/4	61,120	5/25					38A60-P	614636 <b>24397</b>
A31	1-3/8 x 1	1/4	27,780	5/25					38A60-P	614636 <b>24399</b>
A34	1-1/2 x 3/8	1/4	25,470	5/25					38A60-P	614636 <b>24402</b>
A36	1-5/8 x 3/8	1/4	23,520	25/250	Oil & Gas 36	662531 <b>45562</b>				
A36	1-5/8 x 3/8	1/4	23,520	5/25					38A60-P	614636 <b>24404</b>
A37	1-1/4 x 1/4	1/4	30,560	5/25					38A60-P	614636 <b>24405</b>
A38	1 x 1	1/4	34,500	5/25			86A80-S	690786 <b>45345</b>	38A60-P	614636 <b>24406</b>
A39	3/4 x 3/4	1/4	47,250	5/25					38A60-P	614636 <b>24407</b>
A40	3/4" Ball	1/4	47,250	5/25					38A60-P	614636 <b>24408</b>

† Standard spindle size is 1/4" x 1-1/2"

\* Maximum RPM valid to 1/2" overhang. See package insert for other overhangs.

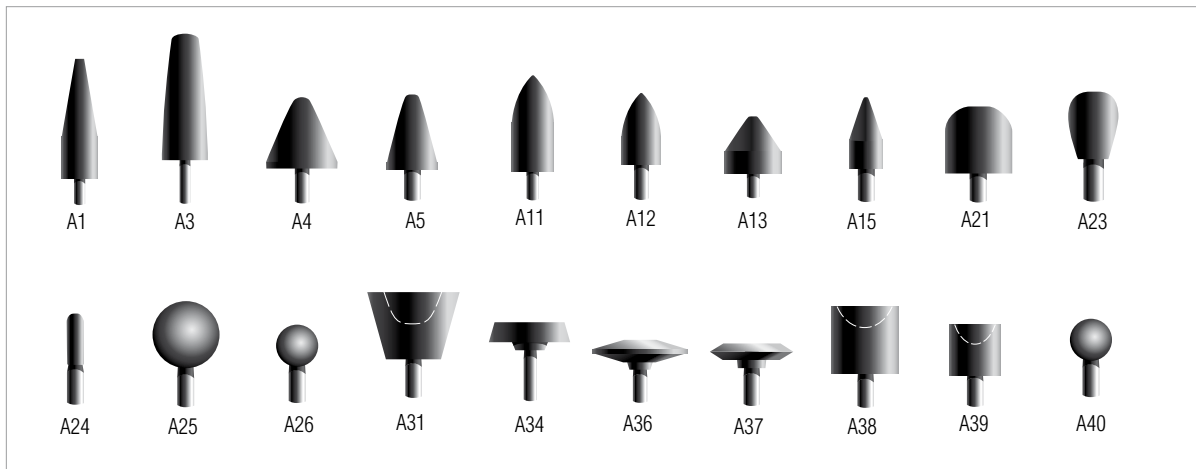

Vitrified Bond

TIER:	<b>BEST</b>	BETTER	<b>NEW</b>	GOOD
TRADENAME:	<b>QUANTUM</b>	<b>PINK</b>		<b>GEMINI</b>
ABRASIVE:	Ceramic Alumina	86A Aluminum Oxide		38A Aluminum Oxide

SHAPE	SIZE (D x T)	SPINDLE DIA. †	MAX. RPM*	MIN./STD. PKG.	SPEC	PART #	SPEC	PART #	SPEC	PART #
<b>Vitrified Bond Mounted Points – B Shapes</b>										
B41	5/8 x 5/8	1/8	33,570	5/25					38A60-P	614636 <b>24410</b>
B42	1/2 X 3/4	1/8	33,570	5/25					38A60-P	614636 <b>24412</b>
B44	7/32 x 3/8	1/8	68,400	5/25					38A60-P	614636 <b>24414</b>
B45	3/16 x 5/16	1/8	104,250	5/25					38A60-P	614636 <b>24415</b>
B46	1/8 x 5/16	1/8	105,000	5/25					38A60-P	614636 <b>24416</b>
B51	7/16 x 3/4	1/8	45,370	5/25					38A60-P	614636 <b>24418</b>
B52	3/8 x 3/4	1/8	45,370	5/25			86A80-S	690786 <b>45334</b>	38A60-P	614636 <b>24420</b>
B52	3/8 x 3/4	1/4	81,000	5/25					38A60-P	614636 <b>24419</b>
B52	3/8 x 3/4	1/8	45,370	5/25					38A90-Q	614636 <b>24422</b>
B53	5/16 x 5/8	1/8	60,000	5/25			86A80-S	690786 <b>45340</b>	38A60-P	614636 <b>24423</b>
B55	1/8 x 1/4	1/8	105,000	5/25					38A60-P	614636 <b>24425</b>
B81	3/4 x 3/16	1/8	50,930	5/25			86A80-S	690786 <b>45347</b>	38A60-P	614636 <b>24437</b>
B91	1/2 x 5/8	1/8	34,500	5/25					38A60-P	614636 <b>24443</b>
B96	1/8 x 1/4	1/8	105,000	5/25					38A90-Q	614636 <b>24449</b>
B97	1/8 x 3/8	1/8	105,000	5/25	3NQ80	690831 <b>49048</b>	86A80-S	690786 <b>45337</b>	38A60-P	614636 <b>24451</b>
B121	1/2" Ball	1/8	45,370	5/25			86A80-S	690786 <b>45338</b>	38A60-P	614636 <b>24466</b>
B122	3/8" Ball	1/8	61,650	5/25	3NQ80	690831 <b>49050</b>	86A80-S	690786 <b>45360</b>	38A60-P	614636 <b>24470</b>
B123	3/16" Ball	1/8	104,250	5/25					38A60-P	614636 <b>24472</b>
B124	1/8" Ball	1/8	105,000	5/25					38A90-Q	614636 <b>24474</b>
B131	1/2 x 1/2	1/8	34,500	5/25					38A60-P	614636 <b>24475</b>
B132	3/8 x 1/2	1/8	45,370	5/25					38A60-P	614636 <b>24479</b>
B135	1/4 x 1/2	1/8	60,000	5/25			86A80-S	690786 <b>45342</b>	38A60-P	614636 <b>24484</b>

† Spindle size is 1/8" or 1/4" x 1-1/2"

\* Maximum RPM valid to 1/2" overhang. See package insert for other overhangs.

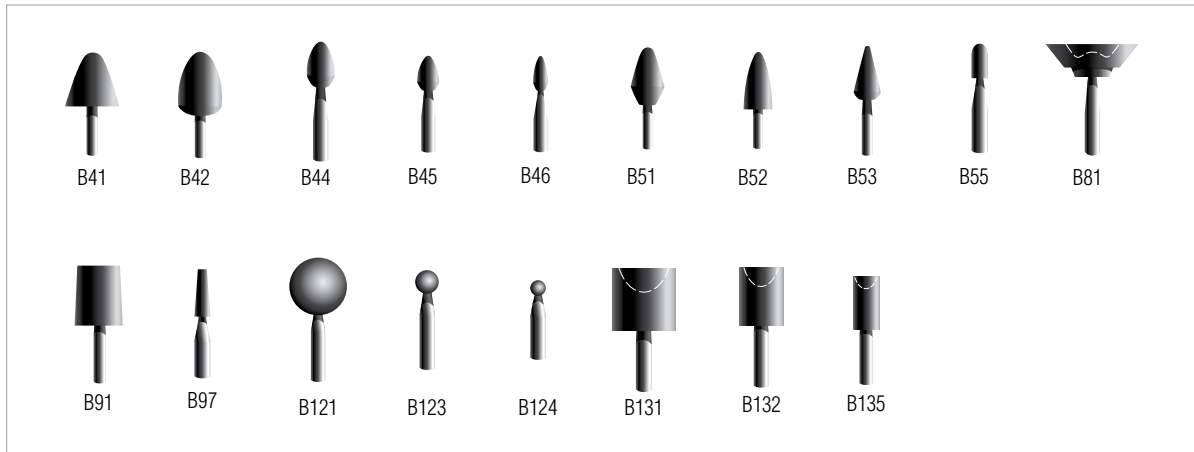

Vitrified Bond

TIER:	<b>BEST</b>	GOOD	<b>NEW</b>	GOOD
TRADENAME:	<b>QUANTUM</b>	<b>PINK</b>		<b>GEMINI</b>
ABRASIVE:	Ceramic Alumina	86A Aluminum Oxide		38A Aluminum Oxide

SHAPE	SIZE (D x T)	SPINDLE DIA. †	MAX. RPM*	MIN./STD. PKG.	SPEC	PART #	SPEC	PART #	SPEC	PART #
<b>Vitrified Bond Mounted Points – W Shapes</b>										
W144	1/8 x 1/4	1/8	105,000	5/25					38A60-P	614636 <b>24488</b>
W145	1/8 x 3/8	1/8	105,000	5/25					38A60-P	614636 <b>24489</b>
W146	1/8 x 1/2	1/8	105,000	5/25					38A60-P	614636 <b>24491</b>
W152	3/16 x 1/4	1/8	105,000	5/25					38A60-P	614636 <b>24495</b>
W153	3/16 x 3/8	1/8	80,850	5/25					38A60-P	614636 <b>24496</b>
W154	3/16 x 1/2	1/8	70,500	5/25	3NQ80	690831 <b>49133</b>			38A60-P	614636 <b>24497</b>
W162	1/4 x 3/8	1/8	64,800	5/25					38A60-P	614636 <b>24503</b>
W163	1/4 x 1/2	1/8	60,000	5/25			86A80-S	690786 <b>45346</b>	38A60-P	614636 <b>24504</b>
W164	1/4 x 3/4	1/8	45,900	5/25					38A60-P	614636 <b>24505</b>
W170	5/16 x 1/2	1/8	52,500	5/25					38A60-P	614636 <b>24511</b>
W175	3/8 x 3/8	1/8	54,000	5/25					38A60-P	614636 <b>24516</b>
W176	3/8 x 1/2	1/8	45,370	5/25					38A60-P	614636 <b>24517</b>
W177	3/8 x 3/4	1/8	33,750	5/25			86A80-S	690786 <b>45355</b>	38A60-P	614636 <b>24518</b>
W179	3/8 x 1-1/4	1/4	20,415	25/250	Oil & Gas 36	690831 <b>54055</b>				
W185	1/2 x 1/2	1/8	34,500	5/25	3NQ80	690831 <b>49137</b>			38A60-P	614636 <b>24525</b>
W185	1/2 x 1/2	1/4	61,500	5/25			86A80-S	690786 <b>45354</b>	38A60-P	614636 <b>24526</b>
W186	1/2 X 3/4	1/4	51,000	5/25					38A60-P	614636 <b>24528</b>
W188	1/2 x 1-1/2	1/4	30,370	5/25					38A60-P	614636 <b>24530</b>
W189	1/2 x 2	1/4	24,000	25/250	Oil & Gas 36	614636 <b>86137</b>				
W189	1/2 x 2	1/4	24,000	5/25					38A60-P	614636 <b>24531</b>
W196	5/8 x 1	1/4	35,250	5/25					38A60-P	614636 <b>24539</b>
W200	3/4 x 1/8	1/8	50,930	5/25			86A80-S	690786 <b>45356</b>	38A60-P	614636 <b>24543</b>
W200	3/4 x 1/8	1/8	50,930	5/25					38A90-Q	614636 <b>24544</b>
W204	3/4 x 3/4	1/4	42,750	5/25					38A60-P	614636 <b>24549</b>
W205	3/4 x 1	1/4	34,500	5/25					38A60-P	614636 <b>24550</b>
W208	3/4 x 2	1/4	18,750	5/25					38A60-P	614636 <b>24553</b>
W215	1 x 1/8	1/8	38,200	5/25					38A60-P	614636 <b>24560</b>
W216	1 x 1/4	1/4	38,200	5/25					38A60-P	614636 <b>24562</b>
W218	1 x 1/2	1/4	38,200	25/250	Oil & Gas 36	690831 <b>54061</b>				
W218	1 x 1/2	1/4	38,200	5/25					38A60-P	614636 <b>24564</b>
W220	1 x 1	1/4	25,500	5/25			86A80-S	690786 <b>45359</b>	38A60-P	614636 <b>24566</b>
W222	1 x 2	1/4	15,900	5/25					38A60-P	614636 <b>24569</b>
W230	1-1/4 x 1-1/4	1/4	20,400	5/25					38A60-P	614636 <b>24578</b>
W235	1-1/2 x 1/4	1/4	25,470	5/25			86A80-S	690786 <b>45343</b>	38A60-P	614636 <b>24583</b>
W236	1-1/2 x 1/2	1/4	25,470	5/25					38A60-P	614636 <b>24585</b>
W237	1-1/2 x 1	1/4	22,500	5/25					38A60-P	614636 <b>24587</b>
W238	1-1/2 x 1-1/2	1/4	15,600	5/25					38A60-P	614636 <b>24588</b>
W242	2 x 1	1/4	19,100	5/25					38A60-P	614636 <b>24592</b>

† Spindle size is 1/8" or 1/4" x 1-1/2"

\* Maximum RPM valid to 1/2" overhang. See package insert for other overhangs.

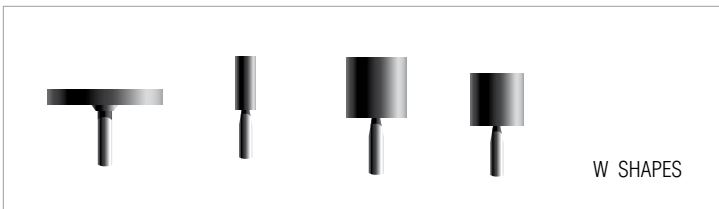



Since 1823, Norton stones have lead the marketplace with conventional and diamond benchstones, waterstones, sharpening systems, files, slips and specialty stones for industrial, commercial and DIY sharpening applications. Our comprehensive line of sharpening and finishing products is the industry's broadest line with premier performance and quality.

**Applications:**

Deburring, dimensioning, sharpening, honing

**Grit Range:**

Coarse, Medium, Fine, Extra Fine, Ultra Fine

**Abrasive Types:**

Aluminum Oxide (India), Silicon Carbide (Crystolon), Arkansas (Soft and Hard Translucent), and Diamond

**Machine Used:**



HAND SHARPENING

## Application-to-Product Recommendation Guide Benchstones

	<b>Coarse/Medium Sharpening</b>	<b>Fine Stoning</b>	<b>Finish Honing</b>
Chip Breakers	–	Fine Crystolon Benchstone	–
Draw Knives	Coarse Crystolon Benchstone	Fine India Benchstone	Hard Arkansas Benchstone
Scrapers	Coarse Crystolon Benchstone	Fine India Benchstone	Hard Arkansas Benchstone
Chisels (Wood)	Coarse Crystolon Benchstone 1000 Waterstone	Fine India Benchstone 4000 Waterstone	Hard Arkansas Benchstone 8000 Waterstone
Plane Blades	Coarse Crystolon Benchstone 1000 Waterstone	Fine India Benchstone 4000 Waterstone	Hard Arkansas Benchstone 8000 Waterstone

## Slips

	<b>Coarse/Medium Sharpening</b>	<b>Fine Stoning</b>
Milling Cutter	Medium India Round Edge Slip	Fine India Round Edge Slip
Carbide Tools		Fine Crystolon Slip for Carbide Tools

## Abrasive Files

	<b>Coarse/Medium Sharpening</b>	<b>Fine Stoning</b>	<b>Finish Honing</b>
Form Cutter	Coarse or Medium India Knife Blade	Fine India Knife Blade	–
Keyways	Coarse or Medium India Square File	Fine India Square File	–
Lathe Bits	Medium India Square File	Fine India Square File	–
Radius Tools	Medium India Round File	Fine India Round File	–
Reamers	Medium India Reamer Stone	Fine India Reamer Stone	–
Router Bits	–	Fine India Square File	–
Saws	Coarse India Triangular File	Fine India Tapered Triangular File	–
Center Punches	Medium India Triangular File	Fine India Triangular File	–
Magnetic Chucks	Medium Crystolon Round File	Fine India Round File	–
Molding Cutters*	Coarse or Medium India File	Fine India File	–
Countersinks	Coarse India Triangular File	Fine India Triangular File	Hard Arkansas Triangular File
Tap Threads	–	Fine India Triangular File	–

\* Select shape to fit configuration

## Instructional Videos

 **YouTube** Find the latest instructional sharpening stone videos on our youtube channel at <https://nortonsga.us/kb542>

Ideal for sales training and end-user self-study. Learn to efficiently use these sharpening products to maintain tools at peak performance and prolong their life – to make all your sharpening, honing, etc. applications easier.

Relative Sharpening Comparisons for Norton Products

Crystolon (Silicon Carbide); India (Aluminum Oxide)	Arkansas (Soft, Hard Translucent)	Diamond Stones	Waterstones	Coated Abrasives (Waterproof Sandpaper)		Diamond Compound
			JIS (Japan)	CAMI (USA)	FEP (Europe)	MICRON Size
Coarse Crystolon					P120	141
				120		127
						116
Coarse India					P150	97
				150		93
						78
Medium Crystolon		Extra Coarse Diamond (220)	Norton 220		P220	65
				220		60
					P240	58
Medium India				240		53.5
					P280	52.5
						50
Fine Crystolon		Coarse Diamond (325)			P320	46
						45
				280		43
Fine India			360		P360	40.5
				320		36
					P400	35
Soft Arkansas		Fine Diamond (600)		360		29
					P600	25.8
				400		23
Hard Translucent Arkansas			600		P800	22
						20
				800	600	P1200
			Norton 1000			14
				700		12.6
				800	P1500	11
			1200			10.3
					P2000	9.2
				1500	1000	
					P2500	8.4
						7.5
				1500		6
			Norton 4000	2000		5
						3
				Norton 8000		1.2
						1
						0.5
				15000		

Benchstones

Better choice for sharpening tools and knives



PRECISION BENCHSTONES

- Jewelers' Benchstones – These stones are excellent for sharpening the fine, precision cutting tools used by jewelers, engravers and artisans
- Penknife Precision Benchstones – Ideal for sharpening cutting tools, laboratory blades, surgical instruments, engravers' and die makers' tools, and pocket knives to the keenest edge

TIER: BETTER

SIZE (L x W x H)	QTY./CASE	SPEC.	PRODUCT #	PART #
<b>Precision Benchstones – Jewelers'</b>				
4 x 2 x 3/8	5	Ultra Fine – Hard Translucent Arkansas	HB24	614636 <b>87525</b>
6 x 2 x 3/8	5	Ultra Fine – Hard Translucent Arkansas	HB26	614636 <b>87530</b>
<i>Jewelers' stones are packed in individual boxes within a case. Order in multiples of stones/case.</i>				
<b>Precision Benchstones – Penknife</b>				
3 x 1 x 3/8	5	Extra Fine – Soft Arkansas	SB13	614636 <b>87560</b>
		Ultra Fine – Hard Translucent Arkansas	HB13	614636 <b>87550</b>
4 x 1 x 3/8	5	Extra Fine – Soft Arkansas	SB14	614636 <b>87565</b>
		Ultra Fine – Hard Translucent Arkansas	HB14	614636 <b>87555</b>

Benchstones *continued*



VENDIBLE

Better choice for edge shaping and honing

SINGLE GRIT ABRASIVE BENCHSTONES

- Crystolon – sharp premium silicon carbide abrasive, delivers fast stock removal for quick edge shaping with minimal loading
- India - smooth cutting aluminum oxide abrasive produces a strong, keen, long-lasting edge and is the choice for the best blend of cut rate and finish
- Arkansas – Natural premium Novaculite quarried in Arkansas and available in Soft or Hard Translucent

TIER: BETTER				
SIZE (L x W x H)	QTY./CASE	SPEC.	PRODUCT #	PART #
<b>Single Grit Benchstones – Crystolon (Silicon Carbide)</b>				
4 x 1 x 1/4	5	Coarse	CJB14	614636 <b>85470</b>
	5	Medium	MJB14	614636 <b>85465</b>
	5	Fine	FJB14	614636 <b>85460</b>
	5 V	Fine	FJB14-V	662533 <b>25915+</b>
4 x 1 x 1/2	5	Coarse	CJB24	614636 <b>85485</b>
	5	Medium	MJB24	614636 <b>85480</b>
	5	Fine	FJB24	614636 <b>85475</b>
5 x 2 x 5/8	5	Medium	MJB35	614636 <b>85495</b>
	5	Fine	FJB35	614636 <b>85490</b>
6 x 2 x 1	5	Coarse	CJB6	614636 <b>85510</b>
	5	Medium	MJB6	614636 <b>85505</b>
	5	Fine	FJB6	614636 <b>85500</b>
8 x 2 x 1	5	Coarse	CJB8	614636 <b>85525</b>
	5	Medium	MJB8	614636 <b>85520</b>
	5	Fine	FJB8	614636 <b>85515</b>
8 x 3 x 1/2	5	Coarse	CJB83	614636 <b>54459*</b>
	5	Medium	MJB83	614636 <b>54458*</b>
	5	Fine	FJB83	614636 <b>54457*</b>
11-1/2 x 2-1/2 x 1/2	1	Coarse	JM3	614636 <b>85980#</b>
	1	Medium	JM6	614636 <b>85975#</b>
<b>Single Grit Benchstones – Soft Arkansas</b>				
4 x 2 x 3/4-1	5	Extra Fine	SB4	614636 <b>85670</b>
6 x 2 x 3/4-1	5	Extra Fine	SB6	614636 <b>85675</b>
8 x 2 x 3/4-1	5	Extra Fine	SB8	614636 <b>85680</b>

TIER: BETTER				
SIZE (L x W x H)	QTY./CASE	SPEC.	PRODUCT #	PART #
<b>Single Grit Benchstones – India (Aluminum Oxide)</b>				
4 x 1 x 1/4	5	Coarse	CB14	614636 <b>85580</b>
	5	Medium	MB14	614636 <b>85575</b>
	5	Fine	FB14	614636 <b>85570</b>
	5 V	Fine	FB14-V	662533 <b>25919</b>
4 x 1 x 1/2	5	Coarse	CB24	614636 <b>85595</b>
	5	Medium	MB24	614636 <b>85590</b>
	5	Fine	FB24	614636 <b>85585</b>
5 x 2 x 5/8	5	Medium	MB35	614636 <b>85605</b>
	5	Fine	FB35	614636 <b>85600</b>
6 x 2 x 1	5	Coarse	CB6	614636 <b>85620</b>
	5	Medium	MB6	614636 <b>85615</b>
	5	Fine	FB6	614636 <b>85610</b>
8 x 2 x 1	5	Coarse	CB8	614636 <b>85635</b>
	5	Medium	MB8	614636 <b>85630</b>
	5	Fine	FB8	614636 <b>85625</b>
8 x 3 x 1/2	5	Coarse	CB83	614636 <b>54462*</b>
	5	Medium	MB83	614636 <b>54461*</b>
	5	Fine	FB83	614636 <b>54460*</b>
11-1/2 x 2-1/2 x 1/2	1	Medium	IM6	614636 <b>54214#</b>
	1	Fine	IM9	614636 <b>85970#</b>
<b>Single Grit Benchstones – Hard Translucent Arkansas</b>				
4 x 2 x 3/4-1	5	Ultra Fine	HB4	614636 <b>85655</b>
6 x 2 x 3/4-1	5	Ultra Fine	HB6	614636 <b>85660</b>
8 x 2 x 3/4-1	5	Ultra Fine	HB8	614636 <b>85665</b>
8 x 3 x 1/2	5	Ultra Fine	HTB83	614636 <b>54464*</b>
11-1/2 x 2-1/2 x 1/2	1	Ultra Fine	HM11	614636 <b>85965#</b>

V = Vendible Package. Ideal for vending machines, small jobs, and carrying to job site. Pre-packed in sturdy boxes of 5 per pack. Order by total number of stones needed in multiples of 5.

\* May be used as replacement stone for IM-83 Sharpening System.

# May be used as replacement stone for IM-313 Sharpening Stone System.

These benchstones (except for 8 x 3 x 1/2 and vendibles) are packed in individual boxes within a case. Order in multiples of stones/case.



Benchstones *continued*

Better choice for economical solution for general sharpening and finishing with one stone



## COMBINATION GRIT ABRASIVE BENCHSTONES

- **Crystolon Combination**  
Coarse and fine grit sharp-cutting silicon carbide abrasive surfaces for general sharpening (to moderate tolerances) when the speed of sharpening is more important than the fineness of the cutting edges. Gray in color.
- **India Combination**  
Coarse and fine grit aluminum oxide abrasive surfaces produce strong, keen, long-lasting edges on quality tools. Orange/brown in color.
- **Crystolon/India Combination**  
Fast-sharpening, medium grit silicon carbide (Crystolon) and fine aluminum oxide (India) abrasive surfaces for keen, long-lasting edges on quality tools. Crystolon side is dark gray in color, India side is orange.
- **Giant Combination Stones**  
11-1/2" and 12" bench oil stones are used to sharpen large edge tools with long sweeping strokes.

### Application-to-Product Recommendation Guide

	FAST CUT STOCK REMOVAL	INITIAL SHARPENING	FINAL SHARPENING	HONING	SHARPEST EDGE
Grit Size	Coarse	Medium	Fine	Extra Fine	Ultra Fine
Abrasive	Crystolon	Crystolon	India	Soft Arkansas	Hard Arkansas
Product/Color	Grey	Grey	Orange	Milky White	Translucent

SIZE (L x W x H)	QTY./CASE	SPEC.	TIER: BETTER	
			PRODUCT #	PART #
<b>Combination Grit Benchstones – Crystolon (Silicon Carbide)</b>				
4 x 1 Round	5	Coarse/Fine	JB64	614636 <b>85435</b>
4 x 1-3/4 x 5/8	5	Coarse/Fine	JB134	614636 <b>85440</b>
5 x 2 x 3/4	5	Coarse/Fine	JB45	614636 <b>85445</b>
6 x 2 x 1	5	Coarse/Fine with Anniversary Box	JB6	614636 <b>85450</b>
8 x 2 x 1	5	Coarse/Fine with Anniversary Box	JB8	614636 <b>85455</b>
11-1/2 x 2-1/2 x 1	2	Coarse/Fine	JUM3	614636 <b>85840</b>
12 x 2-1/2 x 1-1/2	2	Coarse/Fine	JUM4	614636 <b>85855</b>
<b>Combination Grit Benchstones – India (Aluminum Oxide)</b>				
4 x 1 Round	5	Coarse/Fine	IB64	614636 <b>85545</b>
4 x 1-3/4 x 5/8	5	Coarse/Fine	IB134	614636 <b>85550</b>
5 x 2 x 3/4	5	Coarse/Fine	IB45	614636 <b>85555</b>
6 x 2 x 1	5	Coarse/Fine with Anniversary Box	IB6	614636 <b>85560</b>
8 x 2 x 1	5	Coarse/Fine with Anniversary Box	IB8	614636 <b>85565</b>
11-1/2 x 2-1/2 x 1	2	Coarse/Fine	IM2	614636 <b>85851</b>
<b>Combination Grit Benchstones – Crystolon/India</b>				
6 x 2 x 1	5	Medium/Fine	IC6	614636 <b>85643</b>
11-1/2 x 2 x 1	2	Medium/Fine	IC11	614636 <b>87239</b>

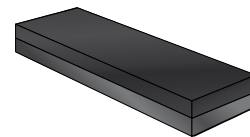

*These benchstones are packed in individual boxes within a case. Order in multiples of stones/case.*

## Waterstones

Waterstones are synthetic stones designed to be softer than oil stones. These softer grade stones are used with water as the lubricant (versus oil) to develop a fast cutting slurry. The Norton Waterstone system was designed in a carefully planned sequence to create sharpening efficiency. You get the level of abrasiveness you need at each stage, without wasting time trying to sharpen your tools on a grit that is too fine, too soon.

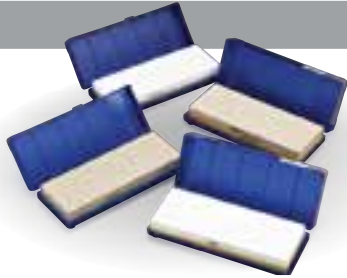

Better choice for producing superior edges on planes and straight chisels

## WATERSTONES

- Synthetic stones designed to work together, with water for fast sharpening, fine finish
- Softer than traditional oilstones - providing lapping action for superb results with low pressure
- Color-coded by grit: 220 grit for repairing badly damaged tools, 1000 grit for initial cut, 4000 grit for excellent finishing, and 8000 grit for polishing



Better choice for raising slurry

## PREP STONE

- This synthetic stone enhances the performance of waterstones by speeding up the slurry-making process needed to cut and polish with waterstones
- This prep stone is designed to raise the slurry on waterstones without significantly altering the dimensions of the stone
- Waterstones are great for producing superior edges for planes and straight chisels

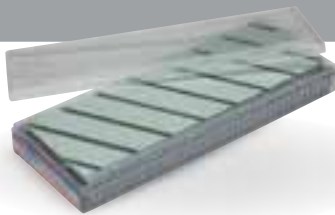

Better choice for producing flat surfaces on waterstones

## FLATTENING STONE

- Coarse grit silicon carbide stone promotes fast results
- Diagonal grooves increase swarf removal
- Superbly flat with hard bond to produce extremely flat surfaces on all waterstones

SIZE (L x W x H)	QTY./CASE	SPEC.	TIER: <b>BETTER</b>	PART #
<b>Waterstones – Single Grit</b>				
8 x 3 x 1	5	220		614636 <b>89505</b>
	5	1000		614636 <b>89506</b>
	5	4000		614636 <b>89507</b>
	5	8000		614636 <b>89508</b>
Set	1	4 Stones: 220, 1000, 4000, 8000 Grit		614636 <b>24334</b>
<b>Waterstones – Combination Grit</b>				
8 x 3 x 1	5	220 / 1000		614636 <b>24335</b>
	5	1000 / 4000		614636 <b>24450</b>
	5	1000 / 8000		699366 <b>55039</b>
	5	4000 / 8000		614636 <b>24336</b>
<b>Prep Stone</b>				
20mm x 20mm x 3"	5	Aluminum Oxide		662434 <b>39361</b>
<b>Flattening Stone</b>				
9 x 3 x 3/4	5	Silicon Carbide		699366 <b>87444</b>
<b>Waterstone Kit</b>				
N/A	1	Kit includes: 1-220/1000 and 1-4000/8000 waterstone, 1 flattening stone		076607 <b>87943</b>

Waterstones are packed in individual boxes within a case. Order in multiples of stones/case.

## TECH TIP

### Maximizing Waterstone Performance

- Wet waterstone
- Rub evenly with the prep stone to create slurry
- Evening off the high spots will make for less-frequent flattening of the waterstones
- Waterstones wear concave with use; periodically flatten with flattening stone

## Instructional Videos

**YouTube** Find the latest instructional waterstone and other sharpening stone videos on our youtube channel at <https://nortonsga.us/kb542>

Ideal for sales training and end-user self-study. Learn to efficiently use these sharpening products to maintain tools at peak performance and prolong their life – to make all your sharpening, honing, etc. applications easier.



## Diamond Benchstones

Made in the USA, these benchstones have unique stackable non-skid rubber feet designed to keep the diamond plate steady while you sharpen, and efficiently stacked for space-saving storage when not in use. Our simple grit-size color-coding makes them easy to differentiate.

Better choice for producing superior edges on planes and straight chisels



## STACKABLE DIAMOND BENCHSTONES

- Flat, diamond surface plated onto a nickel coated steel bar precision ground to a tolerance of .001 in. for fast, even blade and tool edge sharpening
- Continuous diamond sharpening surface for excellent sharpening performance across entire surface of stone
- Choose 220 grit for badly worn tools, 325 for initial sharpening, 600 grit for final sharpening
- Color-coded tabs on stones and packaging for easy identification of grit sizes for use and displaying
- Stackable; the stones firmly stack on top of each other for easy, small-profile storage
- Non-skid rubber base stays in place while sharpening for smoother, efficient sharpening

SIZE WITH RUBBER FEET (L x W x H)	QTY./ CASE	SPEC.	TIER: BETTER	
			PRODUCT #	PART #
<b>Stackable Diamond Benchstones</b>				
6 x 2 x 1/4*	5	D220	662532	<b>68082</b>
6 x 2 x 1/4*	5	D325	662532	<b>68081</b>
6 x 2 x 1/4*	5	D600	662532	<b>68080</b>

*Diamond benchstones are packed in individual boxes within a case. Order in multiples of stones/case.*



6" stones come retail packaged

## Sharpening Stone Oil

Better choice for improving sharpening stone performance



## SHARPENING STONE OIL

- Highly refined lubricating oil which is specifically formulated for sharpening stone use
- Will not load or "gum-up" sharpening stones, meets U.S. Pharmacopoeia standards for mineral oil purity; may be used around food preparation operations
- Equally ideal for all lubricating jobs

SIZE	QTY./ CASE	SPEC.	TIER: BETTER	
			PRODUCT #	PART #
<b>Sharpening Stone Oil</b>				
4-1/2 oz.	20	Oil	XB1	614636 <b>87760</b>
1 Pint	20	Oil	XB5	614636 <b>87770</b>
1 Quart	5	Oil	XB2	614636 <b>87775</b>
1 Gallon	4	Oil	XB6	662534 <b>57631</b>

### TECH TIP

- All oil stones are porous in nature; oil is required to keep the pores open and working efficiently
- Use Norton oil to optimize the performance of Crystolon, India and Arkansas stones
- While sharpening knives, blades and tools, be careful to keep fingers away from sharp edges

## Sharpening Systems

### Tri-Stone Systems

The base of the tri-stone system acts as an oil reservoir permitting continuous submersion of the unused stones, keeping them clean and saturated, ready for immediate use and years of utility. Rotating the handle brings the desired stone into position for sharpening. All offer a range of replacement stones to replace worn or damaged stones, or substitute different specifications to customize the system.



Better choice for large, straight-edged tool sharpening

### IM313 MULTI-OILSTONE SHARPENING SYSTEM

- Considered by many to be the ultimate sharpening system, the IM313 contains three oil stones. The 11-1/2" stone length permits long, sweeping strokes for faster and more precise sharpening and honing of all large, wider straight-edged tools. The heavy base has a non-skid bottom.
- Coarse Crystolon stone quickly restores worn edges for general sharpening; medium Crystolon stone produces the average edge needed for most tools; and fine India stone hones for a sharper edge
- Each IM313 system is included with a pint of Norton oil, plastic angle guide, and reservoir unit



Better choice for a versatile, multi-size tool and knife sharpener

### IM200 PROFESSIONAL SHARPENING SYSTEM

- The smaller 8" stone IM200 system provides the same quality sharpening features as the IM313 – making it the perfect choice for small restaurants and home DIYers
- Coarse Crystolon stone quickly restores worn edges for general sharpening; medium Crystolon stone produces the average edge needed for most tools; and fine India stone hones for a sharper edge
- Contains 4-1/2 oz. of lubricating oil, plastic angle guide, and the reservoir unit



Better choice for small straight-edged tool sharpening

### IM100 3-IN-1 TOOL AND KNIFE SHARPENING SYSTEM

- The smallest system, designed for general sharpening, the IM100 is an affordable choice for small knives, cutlery, and woodworking tools
- Coarse Crystolon stone quickly restores worn edges for general sharpening; medium Crystolon stone produces the average edge needed for most tools; and fine India stone hones for a sharper edge
- 4-1/2 oz. of lubricating oil and a reservoir unit included

### Portable Sharpening Systems



Better choice for all sharpening enthusiasts who carry their system with them

### IM83 PORTABLE SHARPENING STONE SYSTEM

- Sturdy metal latches secure the cover and storage case – where small tools can be housed. The IM83 system is designed like all our other sharpening systems; the stones can be replaced to customize the unit to individual requirements
- Ideal for industrial toolrooms, restaurants, knife manufacturers, DIYers, and sportsmen
- Both IM83 systems include 3 sharpening stones, and a reservoir carrying case; the oil stone system also includes 4-1/2 oz. oil
- IM83-W Portable Waterstone System – Tool Repair to Fine Finishes  
This portable sharpening system is equipped with a carefully engineered sequence of waterstones for clean, efficient sharpening. The waterstones can easily be maintained with the flattening stone provided
- IM83-O Portable Oil Stone System – Straight-Edged Tool Sharpening  
The coarse silicon carbide (Crystolon) stone in this system repairs damaged edges quickly; the medium aluminum oxide (India) stone imparts a durable, smooth cutting edge; and the fine aluminum oxide (India) stone provides the final sharpening and polishing stage

## Sharpening Systems *continued*

### Portable Sharpening Systems *continued*

SIZE	QTY./CASE	SPEC.	PRODUCT #	PART #
<i>TIER: BETTER</i>				
<b>IM313 Multi-Oilstone Sharpening System</b>				
11-1/2 x 2-1/2 x 1/2	1	1 Coarse Crystolon, 1 Medium Crystolon, and 1 Fine India Stone, 1 Pint Oil, Angle Guide, Reservoir Unit	IM313	614636 <b>85960</b>
<b>IM200 Professional Sharpening System</b>				
8 x 2 x 3/8	1	1 Coarse Crystolon, 1 Medium Crystolon, and 1 Fine India Stone, 4-1/2 oz. Oil, Angle Guide, Reservoir Unit	IM200	614636 <b>91260</b>
<b>IM100 3-in-1 Tool and Knife Sharpening System</b>				
6 x 2 x 1/2	1	1 Coarse Crystolon, 1 Medium Crystolon, and 1 Fine India Stone, 4-1/2 oz. Oil, Reservoir Unit	IM100	614636 <b>85356</b>
<b>IM83 Portable Systems</b>				
8 x 3 x 1/2	1	Oilstones: 1 Coarse Crystolon, 1 Medium India, 1 Fine India, 4-1/2 oz. Oil, Reservoir Carrying Case	IM83-O	662435 <b>82823</b>
8 x 3 x 1	1	Waterstones: 1 ea. of 1000, 4000, 8000 Grit, 1 Flattening Stone, Reservoir Carrying Case	IM83-W	662435 <b>82825</b>

For sharpening system replacement stones: see single grit benchstone charts, or your Norton representative for replacement stones and parts which may be used as replacements or to customize your system.

## Abrasive Files

Norton abrasive files hold their shape while imparting the finest, most uniform finish on precision machine parts and in tool and die making. They are ideal for any deburring, chamfering or radiusing job, or for filing delicate parts. Select the file shape that matches the contour of the surface being stoned.

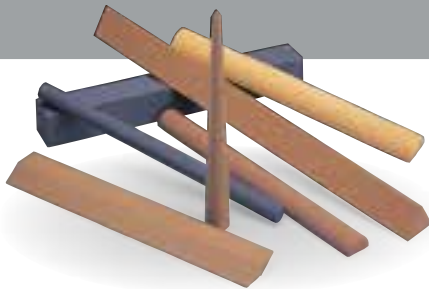

Better choice for any deburring, chamfering or radiusing job, or for filing delicate parts

## ABRASIVE FILES

- Crystolon Files – Fast-acting silicon carbide products. Crystolon files are designed for use where moderate tolerances are acceptable, and speed of sharpening is more important than fineness
- India Files – India files are ideal when close tolerance, and strong, keen, long-lasting edges are needed
- Hard Translucent Arkansas Files – Hard Arkansas has an ultra fine grit that produces the finest edge possible while maintaining tolerances unequalled by any other abrasive file. It will also produce a highly polished finish

### Square Abrasive Files

Square File applications range from dimensioning keyways to maintain fit, stoning faces on router bits, touching-up edges of reamer teeth, and lapping/honing to close tolerances to produce the finest edge on precision instruments, die work and delicate tools.



SIZE (L x H)	QTY./CASE	SPEC.	PRODUCT #	PART #
<i>TIER: BETTER</i>				
<b>Square Abrasive Files – Crystolon (Silicon Carbide)</b>				
4 x 1/2	5	Medium	MJF44	614636 <b>86045</b>
	5	Fine	FJF44	614636 <b>86040</b>
<b>Square Abrasive Files – Hard Translucent Arkansas</b>				
3 x 1/4	5	Ultra Fine	HF13	614636 <b>86590</b>
3 x 3/8	5	Ultra Fine	HF33	614636 <b>86595</b>
3 x 1/2	5	Ultra Fine	HF43	614636 <b>86600</b>

All square files are bulk packed

*TIER: BETTER*

SIZE (L x H)	QTY./CASE	SPEC.	PRODUCT #	PART #
<b>Square Abrasive Files – India (Aluminum Oxide)</b>				
4 x 1/4	5	Coarse	CF14	614636 <b>86075</b>
	5	Medium	MF14	614636 <b>86070</b>
	5	Fine	FF14	614636 <b>86065</b>
4 x 3/8	5	Coarse	CF34	614636 <b>86090</b>
	5	Medium	MF34	614636 <b>86085</b>
	5	Fine	FF34	614636 <b>86080</b>
4 x 1/2	5	Coarse	CF44	614636 <b>86105</b>
	5	Medium	MF44	614636 <b>86100</b>
	5 V	Medium	MF44-V	662533 <b>25913</b>
	5	Fine	FF44	614636 <b>86095</b>
6 x 1/2	5	Coarse	CF46	614636 <b>86120</b>
	5	Medium	MF46	614636 <b>86115</b>
	5	Fine	FF46	614636 <b>86110</b>
6 x 5/8	5	Medium	MF56	614636 <b>86130</b>
	5	Fine	FF56	614636 <b>86125</b>
	6 x 3/4	5	Coarse	CF66
5		Medium	MF66	614636 <b>86145</b>
5		Fine	FF66	614636 <b>86140</b>
6 x 1	5	Coarse	CF76	614636 <b>86165</b>
	5	Medium	MF76	614636 <b>86160</b>
	5	Fine	FF76	614636 <b>86155</b>

V = Vendible Package. Ideal for vending machines, small jobs, and carrying to job site. Pre-packed in sturdy boxes of 5 per pack. Order by total number of stones needed in multiples of 5.

## Abrasive Files *continued*

### Triangular Abrasive Files

Triangular Files are used for a variety of deburring, chamfering and radiusing applications including cleaning tap threads, stoning cutting surfaces of milling cutters, lapping honing tools, dies and molds, and putting precision points on center punches.

The India line also offers Tapered Triangles, used by mechanics and tool and die makers to impart the correct edge in the least time.



TIER: BETTER

SIZE (L x H)	QTY./CASE	SPEC.	PRODUCT #	PART #
<b>Triangular Abrasive Files – Crystolon (Silicon Carbide)</b>				
4 x 1/4	5	Fine	FJF114	614636 <b>86185</b>
4 x 1/2	5	Fine	FJF144	614636 <b>86205</b>
<b>Triangular Abrasive Files – Hard Translucent Arkansas</b>				
3 x 1/4	5	Ultra Fine	HF113	614636 <b>86620</b>
3 x 3/8	5	Ultra Fine	HF133	614636 <b>86625</b>
3 x 1/2	5	Ultra Fine	HF143	614636 <b>86630</b>

All Triangular files are bulk packed

### Round Abrasive Files

Half Round Files offer both a round and a flat surface for imparting a fine finish on precision machine parts, tools and dies.

Round Files are ideal for deburring, chamfering, radiusing, lapping, honing, cleaning radius tools to a burr-free edge, and dimensioning compound curves on templates.

Round Pointed Files are ideally suited for engravers and die sinkers for stoning difficult recesses on instruments and die tools.

Round Tapered Files are used by craftsmen, woodworkers, and die makers as their unique shape imparts the correct edge quickly.

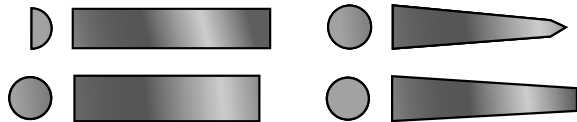

TIER: BETTER

SIZE (L x D)	QTY./CASE	SPEC.	PRODUCT #	PART #
<b>Half Round Abrasive Files – India (Aluminum Oxide)</b>				
4 x 1/4	5	Medium	MF314	614636 <b>86355</b>
		Fine	FF314	614636 <b>86350</b>
4 x 3/8	5	Medium	MF334	614636 <b>86385</b>
		Fine	FF334	614636 <b>86380</b>
4 x 1/2	5	Coarse	CF344	614636 <b>86405</b>
		Medium	MF344	614636 <b>86400</b>
		Fine	FF344	614636 <b>86395</b>

All Half-Round and Round files are bulk packed

TIER: BETTER

SIZE (L x H)	QTY./CASE	SPEC.	PRODUCT #	PART #
<b>Triangular Abrasive Files – India (Aluminum Oxide)</b>				
4 x 1/4	5	Coarse	CF114	614636 <b>86240</b>
		Medium	MF114	614636 <b>86235</b>
		Fine	FF114	614636 <b>86230</b>
4 x 3/8	5	Coarse	CF134	614636 <b>86255</b>
		Medium	MF134	614636 <b>86250</b>
		Fine	FF134	614636 <b>86245</b>
4 x 1/2	5	Coarse	CF144	614636 <b>86270</b>
		Medium	MF144	614636 <b>86265</b>
		Fine	FF144	614636 <b>86260</b>
6 x 1/2	5	Coarse	CF146	614636 <b>86285</b>
		Medium	MF146	614636 <b>86280</b>
		Fine	FF146	614636 <b>86275</b>
6 x 5/8	5	Medium	MF156	614636 <b>86295</b>
		Fine	FF156	614636 <b>86290</b>
6 x 3/4	5	Medium	MF166	614636 <b>86310</b>
		Fine	FF166	614636 <b>86305</b>
6 x 1	5	Medium	MF176	614636 <b>86325</b>
		Fine	FF176	614636 <b>86320</b>
<b>Triangular Tapered Abrasive Files – India (Aluminum Oxide)</b>				
4 x 1/2 x 1/4	5	Medium	MF544	614636 <b>86685</b>
		Fine	FF544	614636 <b>86680</b>

TIER: BETTER

SIZE (L x D)	QTY./CASE	SPEC.	PRODUCT #	PART #
<b>Round Abrasive Files – Crystolon (Silicon Carbide)</b>				
4 x 1/4	5	Medium	MJF214	614636 <b>86430</b>
		Fine	FJF214	614636 <b>86425</b>
4 x 3/8	5	Medium	MJF234	614636 <b>86440</b>
<b>Round Abrasive Files – India (Aluminum Oxide)</b>				
4 x 1/4	5	Coarse	CF214	614636 <b>86480</b>
		Medium	MF214	614636 <b>86475</b>
		Fine	FF214	614636 <b>86470</b>
4 x 3/8	5	Coarse	CF234	614636 <b>86495</b>
		Medium	MF234	614636 <b>86490</b>
		Fine	FF234	614636 <b>86485</b>
4 x 1/2	5	Coarse	CF244	614636 <b>86510</b>
		Medium	MF244	614636 <b>86505</b>
		Fine	FF244	614636 <b>86500</b>
6 x 1/2	5	Coarse	CF246	614636 <b>86525</b>
		Medium	MF246	614636 <b>86520</b>
		Fine	FF246	614636 <b>86515</b>
6 x 5/8	5	Medium	MF256	614636 <b>86535</b>
6 x 3/4	5	Medium	MF266	614636 <b>86550</b>
6 x 1	5	Medium	MF276	614636 <b>86565</b>
<b>Round Abrasive Files – Hard Translucent Arkansas</b>				
3 x 1/4	5	Ultra Fine	HF813	614636 <b>86800</b>
<b>Round Pointed Abrasive Files – India (Aluminum Oxide)</b>				
3 x 5/16 Base	5	Coarse	CF723	614636 <b>86750</b>
		Medium	MF723	614636 <b>86745</b>
		Fine	FF723	614636 <b>86740</b>
<b>Round Pointed Abrasive Files – Hard Translucent Arkansas</b>				
3 x 1/4 Base	5	Ultra Fine	HF863	614636 <b>86825</b>
<b>Round Tapered Abrasive Files – India (Aluminum Oxide)</b>				
4 x 1/2 x 1/4	5	Coarse	CF644	614636 <b>86660</b>
		Medium	MF644	614636 <b>86655</b>
		Fine	FF644	614636 <b>86650</b>

## Abrasive Files *continued*

### Diamond-Shaped Abrasive Files

Diamond-shaped Files are precision sharpening favorites for cleaning acute angles in dies and molds, and for stoning geometric chasers and sewing machine feeds.



TIER: BETTER				
SIZE (L x W x H)	QTY./CASE	SPEC.	PRODUCT #	PART #
<b>Diamond-Shaped Abrasive Files – India (Aluminum Oxide)</b>				
4 x 9/16 x 3/16	5	Coarse	CT134	614636 <b>86720</b>
	5	Medium	MT134	614636 <b>86715</b>
	5	Fine	FT134	614636 <b>86710</b>
<b>Diamond-Shaped Abrasive File – Hard Translucent Arkansas</b>				
3 x 1/2 x 3/16	5	Ultra Fine	HF843	614636 <b>86815</b>

*All Diamond-shaped files are bulk packed*

### Beveled Abrasive Files

Beveled Files are preferred by exacting artisans, jewelers, mechanics, and watchmakers for honing the finest of finishes. These extremely hard files provide years of service.



TIER: BETTER				
SIZE (L x W x H)	QTY./CASE	SPEC.	PRODUCT #	PART #
<b>Beveled Abrasive File – Hard Translucent Arkansas</b>				
3 x 3/8 x 1/8	5	Ultra Fine	HF833	614636 <b>86810</b>

*All Beveled files are bulk packed*

### Flat Abrasive Files

The Flat File is the choice of mechanics, artisans and jewelers. This long lasting file produces the finest finishes.



TIER: BETTER				
SIZE (L x W x H)	QTY./CASE	SPEC.	PRODUCT #	PART #
<b>Flat Abrasive File – Hard Translucent Arkansas</b>				
3 x 3/8 x 1/8	5	Ultra Fine	HF823	614636 <b>86805</b>

*All Flat files are bulk packed*

### Oval Abrasive Files

The Oval File's shape makes it ideal for finishing and honing recesses or curved edges of precision instruments.



TIER: BETTER				
SIZE (L x W x H)	QTY./CASE	SPEC.	PRODUCT #	PART #
<b>Oval Abrasive File – Hard Translucent Arkansas</b>				
3 x 1/2 x 3/16	5	Ultra Fine	HF853	614636 <b>86820</b>

*All Oval files are bulk packed*

### Knife Blade Abrasive Files

Knife Blade Files are used by clock and watch makers to quickly sharpen, hone, and maintain the edges and points of cutting tools.



TIER: BETTER				
SIZE (L x W x H)	QTY./CASE	SPEC.	PRODUCT #	PART #
<b>Knife Blade Abrasive Files – India (Aluminum Oxide)</b>				
4 x 1 x 1/8 Back	5	Coarse	CF724	614636 <b>86780</b>
	5	Medium	MF724	614636 <b>86775</b>
	5	Fine	FF724	614636 <b>86770</b>
<b>Knife Blade Abrasive File – Hard Translucent Arkansas</b>				
3 x 3/4 x 1/8	5	Ultra Fine	HF873	614636 <b>86830</b>

*All Knife Blade files are bulk packed*

### Abrasive File Sets

#### Hard Translucent Arkansas File Set

This set provides a selection of our most popular square, triangular, round and knife blade files in ultra fine Hard Translucent Arkansas for honing and polishing a wide range of configurations.

#### Hard Translucent Arkansas-India File Set

This set contains an assortment of files for finishing, honing and polishing applications. It contains a selection of the most popular square, triangular, round and knife blade files in both fine grit India and ultra fine grit Hard Translucent Arkansas.



TIER: BETTER			
SIZE (L x W x H)	QTY./CASE	PRODUCT #	PART #
<b>File Set – Hard Translucent Arkansas</b>			
	1		614636 <b>86839</b>
1 Each of Ultra Fine Hard Arkansas HF13, HF113, HF813, and HF873			
<b>File Set – Hard Translucent Arkansas and India (Aluminum Oxide)</b>			
	1		614636 <b>86840</b>
1 Each of Ultra Fine Hard Arkansas HF13, HF43, HF113, HF813, HF873, and Fine India FF14, FF44, FF114, FF214, FF724			

See the "Norton Professional Sharpening Products and Dressing Sticks Catalog #200" on [www.nortonabrasives.com](http://www.nortonabrasives.com) to view the complete list and descriptions of our many sharpening products.

## Abrasive Files *continued*

### Engravers' Chuck & Points

Engravers' Points are the choice of professional die-makers for cleaning tight corners and recesses where close tolerances and accuracy are a must. The Engravers' Chuck is a knurled nickel-plated tool designed to hold the Engravers' Point.

SIZE (L x POINT)	QTY./CASE	SPEC.	PRODUCT #	PART #
<i>TIER: BETTER</i>				
<b>Engravers' Chuck</b>				
Engravers' Chuck	5		XT1	614636 <b>87485</b>
<b>Engravers' Point – India (Aluminum Oxide)</b>				
1 x 1/8 Point	5	Fine	FT11	614636 <b>87495</b>
<b>Engravers' Point – Soft Arkansas</b>				
1 x 1/8 Point	5	Extra Fine	AT11	614636 <b>87490</b>

All Engravers' Chucks and Points are bulk packed.



### Silversmith Precision Files

These aluminum oxide precision-shaped stones are designed for use by silversmiths and mechanics for close tolerance lapping, touching-up instruments, and for cleaning tools and dies.

SIZE	QTY./CASE	SPEC.	PRODUCT #	PART #
<i>TIER: BETTER</i>				
<b>Silversmith Precision Files – India (Aluminum Oxide)</b>				
4 x 5/16 x 3/16 x 5/16 x 1/16 - X	5	Medium	MF414	614636 <b>86855</b>
	5	Fine	FF414	614636 <b>86850</b>
4 x 3/8 x 3/16 x 1/8 x 1/16 - Y	5	Fine	FF424	614636 <b>86910</b>
4 x 1/2 x 1/16 - BB	5	Coarse	CF444	614636 <b>86965</b>
	5	Medium	MF444	614636 <b>86960</b>
	5	Fine	FF444	614636 <b>86955</b>
4 x 1/2 x 1/4 x 5/16 x 1/8 - EE	5	Medium	MF474	614636 <b>87005</b>
	5	Fine	FF474	614636 <b>87000</b>

All Silversmith Precision Files are bulk packed.

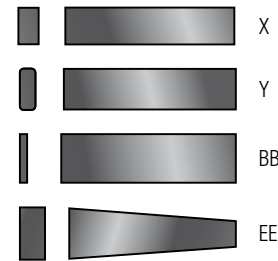

## Pocket Stones



Better choice for outdoor enthusiasts

### POCKET STONES

- Convenient and easily transported
- Ideal for outdoor enthusiasts to sharpen scissors, knives, axes, etc.
- Available in a protective case

SIZE (L x W x H)	QTY./CASE	SPEC.	PRODUCT #	PART #
<i>TIER: BETTER</i>				
<b>Sportsman Pocket Stone – India (Aluminum Oxide)</b>				
3 x 1-1/2 x 1/2	50	Coarse/Fine	IBP4	614636 <b>90705</b>
<b>Pocket Stone – India (Aluminum Oxide)</b>				
4 x 3/4 x 1/4	25	Fine	IBP4	614636 <b>24153</b>
<b>Pocket Stone with Case – India (Aluminum Oxide)</b>				
3 x 7/8 x 3/8 with case	50	Fine	FBP3	614636 <b>91122</b>
<b>Pocket Stone with Case – Crystolon (Silicon Carbide)</b>				
3 x 7/8 x 3/8 with case	50	Fine	JP14	614636 <b>90703</b>
<b>Pocket Stone with Case – Soft Arkansas</b>				
4 x 1 x 3/4 with case; in retail package	5	Extra Fine		662531 <b>42544</b>
<b>Fish Hook Stone With Pouch – Crystolon Half-Round (Silicon Carbide)</b>				
3 x 1/2 with pouch	50	Fine		614636 <b>24072</b>

All Pocket Stones except 662531**42544** are bulk packed.

## Abrasive Slips



Better choice for imparting fine, uniform finishes

### ABRASIVE SLIPS

- Norton abrasive slips impart the finest, most uniform finishes on curved knives and tools, molders' knives, wood gouges, bead planers, and carbide-tipped tools
- The Crystolon and India stones are designed for preliminary sharpening; the Norton Hard Translucent Arkansas stones are the choice for achieving the finest finish possible
- These fast-acting slips hold their shape and are long lasting

#### Carbide Tool Slips

Crystolon (silicon carbide) Slips are used to maintain the edge of carbide tools – keeping regrinding costs and time to an absolute minimum. Not oil-filled.

#### Round Edge Slips

Round Edge Slips are ideal for precision sharpening and honing of bead planers, curved knives and tools, molders' knives and wood gouges.

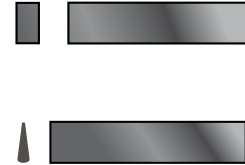

TIER: **BETTER**

SIZE	QTY./CASE	SPEC.	PRODUCT #	PART #
<b>Carbide Tool Slips – Crystolon (Silicon Carbide)</b>				
3-1/2 x 3/4 x 1/2	5	Coarse	CJT63	614636 <b>87295</b>
	5	Medium	MJT63	614636 <b>87290</b>
	5	Fine	FJT63	614636 <b>87285</b>
Set of Three Above	5	Coarse, Medium & Fine	J63	614636 <b>87300</b>
<b>Carbide Tool Slips – India (Aluminum Oxide)</b>				
2-1/4 x 7/8 x 3/16	5	Medium	MS12	614636 <b>87215</b>
<b>Round Edge Slips – Crystolon (Silicon Carbide)</b>				
4-1/2 x 1-3/4 x 1/4 x 3/32	5	Medium	MJS24	614636 <b>87080</b>
	5	Fine	FJS24	614636 <b>87075</b>
4-1/2 x 1-3/4 x 1/2 x 3/16	5	Coarse	CJS44	614636 <b>87100</b>
	5	Medium	MJS44	614636 <b>87095</b>
	5	Fine	FJS44	614636 <b>87090</b>
6 x 2-1/4 x 3/4 x 3/8	5	Medium	MJS66	614636 <b>87110</b>
	5	Fine	FJS66	614636 <b>87105</b>
<b>Round Edge Slips – India (Aluminum Oxide)</b>				
4 x 1 x 7/16 x 3/16	5	Medium	MS14	614636 <b>87140</b>
	5	Fine	FS14	614636 <b>87135</b>
4-1/2 x 1-3/4 x 1/4 x 3/32	5	Coarse	CS24	614636 <b>87155</b>
	5	Medium	MS24	614636 <b>87150</b>
	5	Fine	FS24	614636 <b>87145</b>
4-1/2 x 1-3/4 x 3/8 x 1/8	5	Coarse	CS34	614636 <b>87170</b>
	5	Medium	MS34	614636 <b>87165</b>
	5	Fine	FS34	614636 <b>87160</b>
4-1/2 x 1-3/4 x 1/2 x 3/16	5	Coarse	CS44	614636 <b>87185</b>
	5	Medium	MS44	614636 <b>87180</b>
	5	Fine	FS44	614636 <b>87175</b>
5 x 1 x 5/16 x 3/32	5	Medium	MS15	614636 <b>87195</b>
	5	Fine	FS15	614636 <b>87190</b>
<b>Round Edge Slips – Soft Arkansas</b>				
4 x 1-3/4 x 3/8 x 1/8	5	Extra Fine	SS4	614636 <b>87055</b>
<b>Round Edge Slips – Hard Translucent Arkansas</b>				
3 x 1-3/4 x 1/4 x 1/16	5	Ultra Fine	HS3	614636 <b>87040</b>
4 x 1-1/4 x 1/4 x 1/8	5	Ultra Fine	HS14	614636 <b>87050</b>
4 x 1-3/4 x 3/8 x 1/8	5	Ultra Fine	HS4	614636 <b>87045</b>

All Slips are bulk packed.

## Specialty Stones



Better choice for specific sharpening or deburring applications

## SPECIALTY STONES

- Norton continues to offer specialty stones with optimum specifications and unique shapes that conform to, and quickly sharpen, specific tools

### Specialty Stones for Machine Tools

#### Gouge Sharpening Stone

This stone has a unique shape for sharpening and lapping inside and outside curved surfaces on gouges and other cutting tools.

#### Jointer Stones

These stones provide a fast method of restoring and maintaining the cutting edges of mechanical jointing devices on automatic planers.

#### Machine Knife Stone

Crystolon (silicon carbide) machine knife stones offer both coarse and fine sides for sharpening and honing paper and cloth-cutting knives and planer knives on the machine. The groove around the middle of the stone protects fingers and provides a secure hold.

#### Reamer Stones

Durable, fast-cutting stones designed for imparting a professional edge on reamers, taps, and rough rounders on shoe machine tools.

#### Boat Stones

Boat Stones are medium grit, medium grade stones that are easy to hold and use. Excellent for deburring and breaking sharp edges on dies, fixtures and machined parts, and for deburring grinder magnetic chucks.

SIZE	QTY./CASE	SPEC.	PRODUCT #	PART #
<i>TIER: BETTER</i>				
<b>Gouge Sharpening Stone – India (Aluminum Oxide)</b>				
6 x 2 x 1 x 1/2 x 3/8	5	Fine	FS76	614636 <b>87305</b>
<b>Jointer Stones</b>				
4 x 3/4 x 3/8 – Crystolon (Silicon Carbide)	5	Medium	JE74	614636 <b>87335</b>
4 x 3/4 x 3/8 – India (Aluminum Oxide)	5	Coarse	IE74	614636 <b>87375</b>
<b>Machine Knife Stone – Crystolon (Silicon Carbide)</b>				
4" Diam. x 1-1/2" Thick	5	Coarse/Fine	JB74	614636 <b>87570</b>
<b>Reamer Stones – India (Aluminum Oxide)</b>				
4-1/2 x 1 x 5/16	10	Medium	MT124	614636 <b>87420</b>
	10	Fine	FT124	614636 <b>87415</b>
5 x 1 x 3/16	10	Medium	MT125	614636 <b>87430</b>
	10	Fine	FT125	614636 <b>87425</b>
6 x 1 x 1/4	10	Medium	MT126	614636 <b>87440</b>
	10	Fine	FT126	614636 <b>87435</b>
<b>Boat Stone – Crystolon (Silicon Carbide)</b>				
9 x 2-1/2 x 1-1/2	10	37C80-HV		614636 <b>10369</b>
<b>Boat Stone – India (Aluminum Oxide)</b>				
9 x 2-1/2 x 1-1/2	10	38A60-IVBE		614636 <b>10503</b>

Boat and Reamer Stones are bulk packed. All these other Specialty Stones are packed in individual boxes within a case.

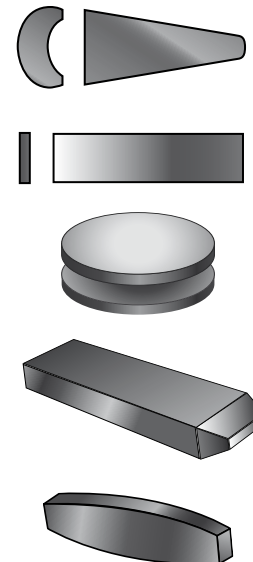

### Large Specialty Stones

#### Tradesmen's Utility Stones

Used for sharpening trimming knives and as an abrasive file in many different industries. The JT910 does not have a handle, while the JT920 and JT930 have wooden handles.

#### Sickle and Scythe Stones

These silicon carbide stones quickly produce a fast-cutting edge on sickles, scythes, and brush hooks. These stones are most frequently chosen where the speed of sharpening is the primary consideration.

#### Utility File

A long wedge-shaped stone with four flat sides designed for sharpening coarse cutting edges on cutting implements and edged garden tools. Wooden handles make them easy to use. They will outlast and out-sharpen metal files.

SIZE	QTY./CASE	SPEC.	PRODUCT #	PART #
<i>TIER: BETTER</i>				
<b>Tradesmen's Utility Stones – Crystolon (Silicon Carbide)</b>				
10 x 1-1/4 x 3/4	10	Medium	JT910	614636 <b>87665</b>
14-3/4 Overall (with Handle)	10	Coarse/Fine	JT930	614636 <b>87675</b>
	10	Medium	JT920	614636 <b>87670</b>
<b>Sickle and Scythe Stones</b>				
10 x 1-1/4 x 3/4 Crystolon (Silicon Carbide)	10	Coarse	TJ3	614636 <b>87731</b>
10 x 1-5/16 x 3/4 India (Aluminum Oxide)	10	Coarse	TD1	614636 <b>87715</b>
<b>Utility File – Crystolon (Silicon Carbide)</b>				
14 Overall (w/ Handle)	10	Coarse	JD2	614636 <b>87750</b>

All Large Specialty Stones are bulk packed.

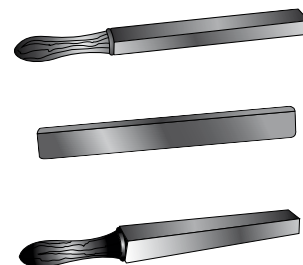



## Retail Packaged Sharpening Products

Our retail-packaged line brings Norton quality to your distributor showroom, vending machine, tool crib, and your tool box. Each stone is specifically designed for a popular sharpening application and packaged to sell or carry to the job site.

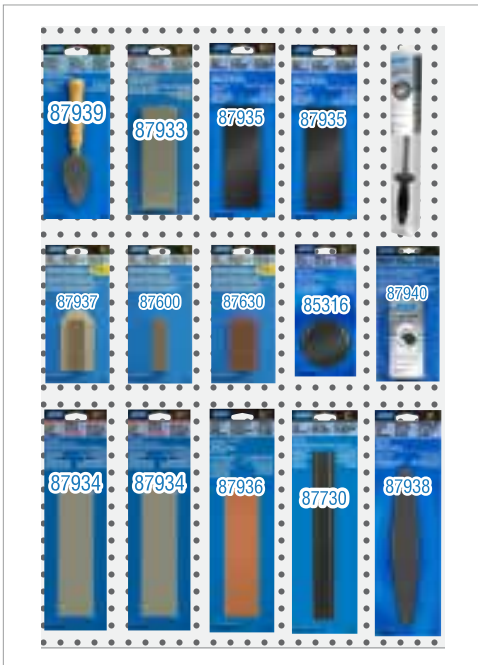

SIZE (L x W x H)	SPEC.	TIER: BETTER	
		QTY./CASE	PART #
<b>Axe and Hatchet Sharpener</b>			
3 x 5/8 round	Coarse/Fine Crystolon (Silicon Carbide)	10	076607 <b>85316</b>
<b>Pocket Knife Sharpener</b>			
3 x 7/8 x 3/8	Fine Crystolon (Silicon Carbide)	5	076607 <b>87600</b>
3 x 7/8 x 3/8 with case	Medium India (Aluminum Oxide)	5	076607 <b>87937</b>
3 x 1-1/2 x 1/2 with case	Coarse/Fine India (Aluminum Oxide)	5	076607 <b>87630</b>
<b>Economy Tool &amp; Knife Benchstone</b>			
6 x 2 x 3/4	Coarse/Fine Crystolon (Silicon Carbide)	5	076607 <b>87933</b>
8 x 2 x 3/4	Coarse/Fine India (Aluminum Oxide)	10	076607 <b>87934</b>
8 x 2 x 1	Coarse/Fine India (Aluminum Oxide)	10	614636 <b>85755</b>
<b>High Quality Tool &amp; Knife Benchstone</b>			
6 x 2 x 3/4	Coarse/Fine Crystolon (Silicon Carbide)	5	076607 <b>87935</b>
<b>Chisel &amp; Planer Blade Sharpener</b>			
8 x 2 x 3/4	Coarse/Fine India (Aluminum Oxide)	10	076607 <b>87936</b>
<b>Household Knife &amp; Tool Sharpener</b>			
7-1/2	Fine Crystolon (Silicon Carbide)	5	076607 <b>87939</b>
<b>Farm Tool Sharpener</b>			
10 x 1-1/4 x 3/4	Coarse Crystolon (Silicon Carbide)	10	076607 <b>87730</b>
<b>Lawn &amp; Garden Tool Sharpener</b>			
9-1/2 x 1-3/8 x 1/2	Medium Crystolon (Silicon Carbide)	10	076607 <b>87938</b>
<b>Sharpening Stone Oil</b>			
4-1/2 oz.	Oil	5	076607 <b>87940</b>
<b>Sharpening Steel</b>			
1/2 x 10	Round file with rubber handle	8	662532 <b>40433</b>
<b>Vitrified Dressing Stick</b>			
1 x 1 x 6	Medium Silicon Carbide	5	076607 <b>10466</b>

## Knife and Scissor Sharpener

The knife and scissor mechanical sharpener is a quick and portable tool for hundreds of sharpening applications.

SPECIFICATION	QTY./CASE	PART #
<b>Knife and Scissor Sharpener</b>		
Carbide	6	076607 <b>87520</b>

## Norton Professional Sharpening Products and Dressing Sticks

See the "Norton Professional Sharpening Products and Dressing Sticks Catalog #200" on [www.nortonabrasives.com](http://www.nortonabrasives.com) to view the complete list and descriptions of our many sharpening products.

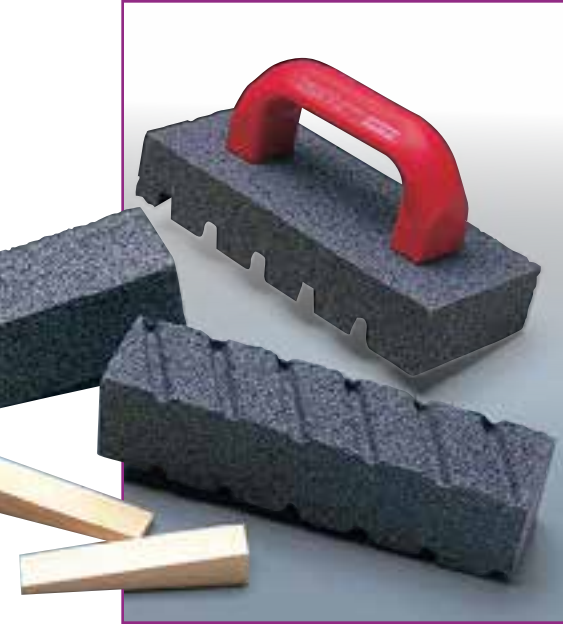

Hard silicon carbide rubbing bricks are used for heavy-duty applications such as rubbing floors, cleaning and scouring castings, rubbing down concrete, and removing mold marks.

**Applications:**

Floor Rubbing Bricks – are used to rub down concrete and remove mold marks. These are designed to fit the chucks of common concrete floor grinding equipment. Reusable wooden wedges anchor the bricks to the equipment chucks.

Plain Hand Rubbing Bricks – are the choice of mechanics and foundry workers for dressing grinding wheels and cleaning or scouring castings.

Fluted Hand Rubbing Bricks – are used by masons and stone workers for rubbing down concrete and removing mold marks. The diagonal flutes provide sharp edges, a clean shearing action, and carry away debris.

Fluted Hand Rubbing Bricks with Handle – make quick work of removing mold marks and rubbing down concrete. The firmly attached handle reduces fatigue and facilitates overhead, wall, and floor work.

Griddle Bricks – quickly clean away carbon build-up and other residue on your grill without leaving fibers, which grill brushes often do.

**Grit Range:**

6 – 120

**Abrasive Type:**

Silicon Carbide

**Machine Used:**

Silicon Carbide



HAND SANDING



ELECTRIC FLOOR STRIPPER



SIZE (L x W x H)	QTY./ CASE	SPEC.	ABRASIVE	PART #
<b>Plain Floor Rubbing Bricks with Wooden Wedges</b>				
4 x 2 x 2	6	C6-R	Silicon Carbide	614636 <b>53292</b>
	6	C10-R	Silicon Carbide	614636 <b>53293</b>
	6	C24-R	Silicon Carbide	614636 <b>53294</b>
	6	C80-R	Silicon Carbide	614636 <b>53295</b>

SIZE (L x W x H)	QTY./ CASE	PART #
<b>Wooden Wedges</b>		
	6	614636 <b>85297</b>

SIZE (L x W x H)	QTY./ CASE	SPEC.	ABRASIVE	PRODUCT #	PART #
<b>Plain Hand Rubbing Bricks</b>					
8 x 2 x 2	5	C24	Silicon Carbide	BP28	614636 <b>87830</b>

SIZE (L x W x H)	QTY./ CASE	SPEC.	ABRASIVE	PRODUCT #	PART #
<b>Fluted Hand Rubbing Bricks</b>					
6 x 2 x 2	5	C20	Silicon Carbide	BF26	614636 <b>87840</b>
8 x 2 x 2	5	C20	Silicon Carbide	BF28	614636 <b>87845</b>

SIZE (L x W x H)	QTY./ CASE	SPEC.	ABRASIVE	PRODUCT #	PART #
<b>Fluted Hand Rubbing Bricks with Handle</b>					
6 x 3 x 1	5	C20	Silicon Carbide	BFH6	614636 <b>87800</b>
8 x 3-1/2 x 1-1/2	5	C20	Silicon Carbide	235	614636 <b>87795</b>

SIZE (L x W x H)	QTY./ CASE	SPEC.	ABRASIVE	PART #
<b>Griddle Brick</b>				
4-1/2 x 3 x 2	5	Medium	Alundum	614636 <b>87870</b>



## improve your **PROCESS, PRODUCTIVITY, AND COST POSITION**

You know the industry-leading performance of our engineered abrasives. Norton R&D has now created new formulations of these abrasives with our exclusive, proprietary Norton Vitrium<sup>3</sup> (VS3) bond. You won't get better productivity from any other grinding wheels and segments.

- Cooler cutting with better chip clearance; improved coolant flow; significantly reduced burn
- Reduced wheel loading
- Improved part quality
- Improved precision profile; ultra-radius accuracy
- Extended wheel life
- Reduced dressing frequency and cost
- Improved cycle and process time
- Able to run at higher operating speed; increased throughput and productivity
- Leverage existing equipment; optimize machine efficiency



### iGrind App

Created by Norton engineers and updated based on feedback from you, the Norton iGrind app features calculators and conversion tools designed to help optimize your grinding processes.

With Norton iGrind, you can calculate the starting parameters for traverse or plunge truing your grinding wheel, determine the ideal setup for delivering coolant to the grinding zone, and convert wheel speeds between RPM, SFPM (Surface Feet Per Minute), and M/Sec to ensure a safe grinding operation.

<https://www.nortonabrasives.com/en-us/igrind>

#### App Features:

- Wheel Speed Converter
- Traverse Diamond Roll Dressing Calculator
- Coolant Calculator
- Plunge Diamond Roll Dressing Calculator
- Stationary Tool Dressing Calculator

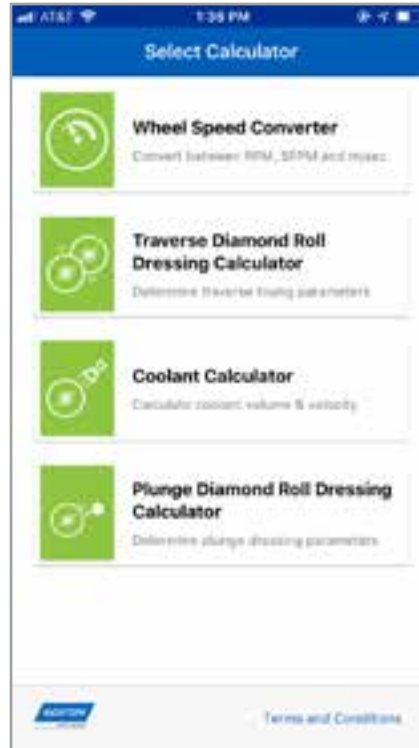

### Standard Grinding Wheel and Periphery Shapes



Type 01  
Straight Wheels



Type 02  
Cylinder Wheels



Type 05  
Recessed One Side  
Wheels

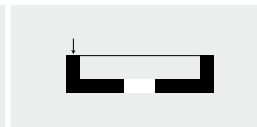

Type 06  
Straight Cup Wheels  
(rim and back)



Type 07  
Double Recessed  
Wheels

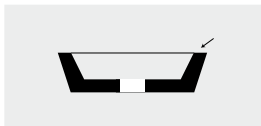

Type 11  
Taper Cup Wheels

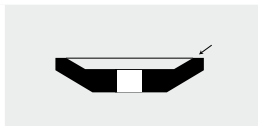

Type 12  
Dish Wheels



Type 31  
Segments

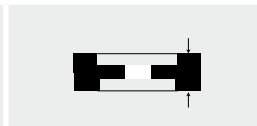

Type 35 and 36  
Discs

### How to Read an Abrasive Product Specification

**Conventional Grinding Wheels**

**32A 46 I 8 V BE**

Abrasive				Grit Size			Grade			Structure	Bond Type	Norton Symbol
Aluminum Oxide	Ceramic	Silicon Carbide	Zirconia Alumina	Coarse	Medium	Fine	Soft	Medium	Hard	Relative grain spacing	Resin = B	Designates a variation or modification to bond.
23A	Oxide	37C	4NZ	12	30	80	D	I	Q	Dense	Shellac = E	
25A	3SGP	39C	4ZF	14	36	90	E	J	R	↑ 2 4 5 6 8 12 16 19 25 28 ↓ Open	Plastic = P	
32A	3SGR	Crystolon	5ZF	16	46	100	F	K	S		Rubber = R	
32AC (blend)	5SG	Masonry	AZ (blend)	20	54	120	G	L	T		Vitrified = V	
38A	BRG		BlueFire	24	60	150	H	M	u			
48A	SG		Charger (blend)	70	220		N	V				
53A	SXG						O	Y				
55A	NorZon Plus (blend)		NZ				P	Z				
57A	NQ		NZC (blend)									
U57A	Quantum		NZIII									
64A	Targa		NZIV									
86A			NorZon									
90A			ZI									
Alundum												
FabCut												
India												
Gemini												
Metal												
Vortex												

### Shelf Life and Proper Storage of Grinding Wheels

It has always been Saint-Gobain Abrasives recommendation that resinoid bonded grinding wheels be used within 2 years from the date of manufacture. This recommendation assumes that resinoid bonded grinding wheels have been stored under ideal storage conditions. It might be true that under ideal storage conditions resinoid bonded grinding wheels can survive without any degradation in strength for well over two years. However, it is always wise to suspect any wheels over two years old and have them reinspected or re-speed tested to determine if there has been any degradation in strength. If the wheels are stored under less than ideal conditions, they might have a much shorter shelf life depending upon the severity of storage conditions. These same comments also apply to rubber and shellac bonded grinding wheels.

As for vitrified grinding wheels, the shelf life is less influenced by humidity and adverse storage conditions as compared to resinoid, rubber or shellac, but even vitrified grinding wheels do not have an infinite shelf life. The best procedure and the best rule of thumb is to have any wheel that is two years old or older re-speed tested and reinspected to ensure it is fit for use. The procedure for having this done and the charges will be explained by our Customer Service Department, but the cost of shipping as well as the cost of re-inspection is the customer's responsibility. Also, any wheels rejected or otherwise lost in the re-inspection process will also be the responsibility of the customer.

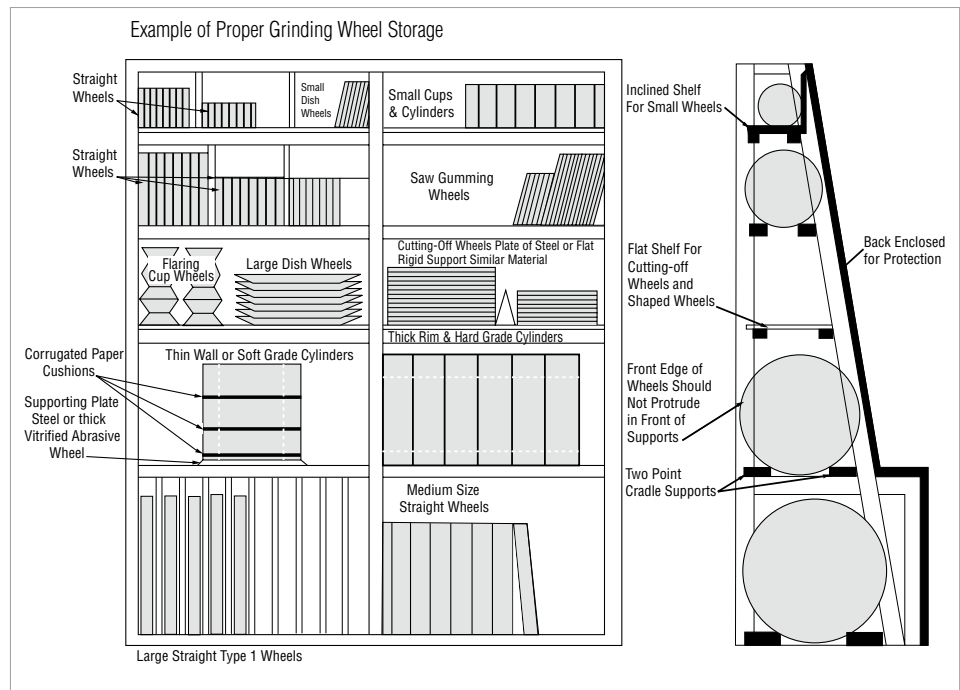

Keep in mind, however, that this procedure is good to verify the reliability of a product but must not be performed until you are ready to consume the wheel. If wheels are sent back after the two year time frame for re-inspection and re-testing and then put back on the shelf, there is no telling how long they will be fit for use after that last inspection. Therefore, these wheels must be consumed as soon as is practical.



The Norton bench and pedestal wheel line consists of numerous wheel diameters and arbor sizes, abrasive types and grit sizes. Our offering answers all metal removal, deburring, shaping and sharpening needs: white aluminum oxide for high-speed tool steels, brown aluminum oxide for carbon steel, and silicon carbide for non-ferrous metals and carbide tooling.

- Applications:** Offhand deburring and sharpening of parts and tools
- Size Range:** 5" – 18"
- Grit Range:** 24 – 150
- Abrasive Types:** Premium Ceramic Alumina, Aluminum Oxide, Silicon Carbide
- Bushings:** Telescopic arbor bushings to fit all popular grinders are packaged with the wheel
- Machine Used:**



BENCH GRINDER



PEDESTAL GRINDER

### Application/Grit Recommendation Guide

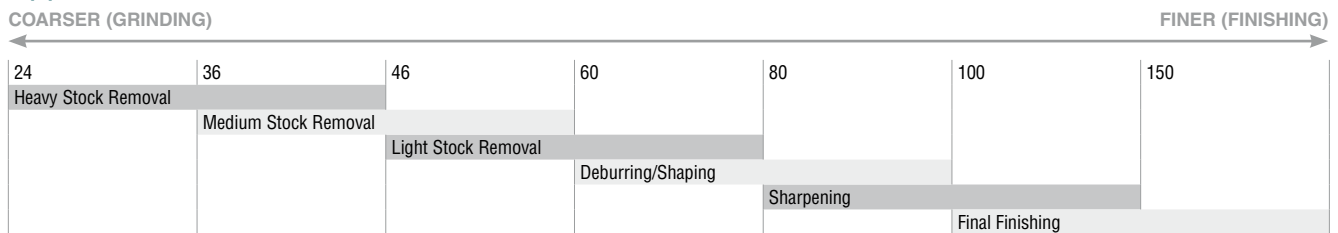

### TECH TIP

- Unsecured machines can move, causing grinding breakage and injury. Fixed-based bench and pedestal grinders **MUST** be secured.
- Do not grind wood, plastic, or any other non-metallic material on a bench or pedestal grinder.
- All bench and pedestal wheels must be dressed to prevent loading. Loading can cause excessive heat, damage to the workpiece, and wheel breakage. Dressing exposes new cutting edges and provides chip clearance.
- Recommended starting dressing stick: 1" x 1" x 6" 37C24-SVK Part # 614636**10462**



It is the user's responsibility to refer to and comply with ANSI B7.1

### Bench and Pedestal Wheel Arbor Bushings

WHEEL DIAMETER	WHEEL CENTER HOLE	1/2"	5/8"	3/4"	7/8"	1"	1-1/4"
5", 6", 7"	1"	•	•	•	•		
8"	1"		•	•	•		
10"	1-1/4"			•	•	•	
12" x 2"	1-1/4"					•	
12" and 14"	1-1/2"					•	•

*These size bushings shipped free of charge with your wheel order.*



**NEW**

Best choice for deburring and tool sharpening on bench and pedestal grinders

## PREMIUM CERAMIC ALUMINA 3SG

- Type 01 straight wheel with ceramic alumina grain has fast cut, minimal burn, and long wheel life
- High performance bond for versatility and exceptional form holding
- Especially great for hollow grinding of plane blades and chisels; telescoping bushings to fit popular arbor hole sizes



Better choice for light metal removal and sharpening of high-speed tool steels (55 Rc and higher)

## PREMIUM WHITE ALUMINUM OXIDE

- Type 01 straight wheel with premium white aluminum oxide for maximum cut rate and cool grinding action on hardened or high-speed tool steels
- Vitrified bonded for superb shape holding and resistance to wear
- Better choice for deburring and tool sharpening on bench and pedestal grinders; telescoping bushings to fit popular arbor hole sizes



Better choice for light to medium stock removal

## 57A ALUMINUM OXIDE

- Type 01 straight wheel, the better choice for the end-user that needs a specific grit size and hardness for engineered applications
- Vitrified bond for superb shape holding and resistance to wear
- Excellent choice for deburring and tool sharpening on bench and pedestal grinders



Better choice for medium grit and grade for light to medium stock removal on carbide tooling and non-ferrous materials

## 39C SILICON CARBIDE

- Type 01 straight wheel with sharp, green silicon carbide; use for performance applications on carbide tooling and non-ferrous materials
- Vitrified bond for superb shape holding and resistance to wear
- Excellent choice for deburring and tool sharpening on bench and pedestal grinders



Good choice for all general-purpose bench and pedestal applications

## GEMINI ALUMINUM OXIDE

- Type 01 straight wheel with quality, aluminum oxide for general purpose bench and pedestal grinder applications on steel
- Vitrified bond for superb shape holding and resistance to wear
- Good choice for deburring and tool sharpening on bench and pedestal grinders; telescoping bushings to fit popular arbor hole sizes



Good choice for all general-purpose bench and pedestal applications on non-ferrous materials and carbide tooling

## GEMINI SILICON CARBIDE

- Type 01 straight wheel with sharp, green silicon carbide for general-purpose applications on carbide tooling and non-ferrous materials
- Vitrified bond for superb shape holding and resistance to wear
- Available in many sizes and coarse to fine grits; for sharpening to fine shaping applications



TIER:	<b>BEST</b>	<b>BETTER</b>	<b>BETTER</b>
TRADENAME:	<b>PREMIUM CERAMIC ALUMINA</b>	<b>PREMIUM ALUMINUM OXIDE</b>	<b>57A</b>
ABRASIVE:	3SG Ceramic Alumina	White Aluminum Oxide	Brown Aluminum Oxide

SIZE (D x T x H)	MAX. RPM	MIN./STD. PKG.	SPEC	PART #	SPEC	PART #	SPEC	PART #
6 x 3/4 x 1	4,140*	1/5	3SG-46K	076607 <b>05411</b>	Medium 60	076607 <b>88246</b>		
	4,140*	1/5	3SG-60I	076607 <b>04684</b>	Fine 100	076607 <b>88247</b>		
	4,140*	1/5	3SG-80K	076607 <b>05412</b>	Very Fine 150	076607 <b>88248</b>		
	4,140*	1/5	3SG-100I	076607 <b>04682</b>				
6 x 1 x 1	4,140*	1/5	3SG-46K	076607 <b>05413</b>	Medium 60	076607 <b>88261</b>		
	4,140*	1/5	3SG-80K	076607 <b>05414</b>	Fine 100	076607 <b>88262</b>		
	4,140	1/5			Very Fine 150	076607 <b>88263</b>		
8 x 1 x 1	3,600	1/5	3SG-46I	076607 <b>04660</b>	Medium 60	076607 <b>88281</b>		
	3,600	1/5	3SG-46K	076607 <b>05421</b>	Fine 100	076607 <b>88282</b>		
	3,600	1/5	3SG-60I	076607 <b>04659</b>	Very Fine 150	076607 <b>88283</b>		
	3,600	1/5	3SG-80K	076607 <b>05422</b>				
	3,600	1/5	3SG-100I	076607 <b>04657</b>				
10 x 1 x 1-1/4	2,485	1/5					57A46-MVBE	662531 <b>16274</b>
	2,485	1/5					57A60-MVBE	662531 <b>16273</b>
10 x 1-1/2 x 1-1/4	2,485	1/5					57A46-MVBE	662531 <b>16280</b>
12 x 1 x 1-1/4	2,070	1/5					57A46-MVBE	662532 <b>20947</b>
12 x 2 x 1-1/2	2,070	1/4					57A30-MVBE	662532 <b>20951</b>
	2,070	1/4					57A36-OVBE	662532 <b>20952</b>
	2,070	1/4					57A46-MVBE	662532 <b>20953</b>
	2,070	1/4					57A60-MVBE	662532 <b>20955</b>
	2,070	1/4					57A24-QVBE	662533 <b>19972</b>
14 x 2 x 1-1/2	1,800	1/3					57A36-OVBE	662533 <b>19973</b>
	1,800	1/3					57A46-MVBE	662533 <b>19974</b>
	1,800	1/3					57A24-QVBE	662533 <b>19976</b>
14 x 2-1/2 x 1-1/2	1,800	1/2					57A46-MVBE	662533 <b>19975</b>
	1,800	1/2					57A36-OVBE	662533 <b>19977</b>
18 x 3 x 1-1/2	1,275	1/2					57A24-QVBE	662534 <b>62610</b>

\* Max. RPM for Premium Ceramic Alumina Wheels is 5,410

### Bench and Pedestal Wheel Arbor Bushings

WHEEL DIAMETER	WHEEL CENTER HOLE	1/2"	5/8"	3/4"	7/8"	1"	1-1/4"
5", 6", 7"	1"	•	•	•	•		
8"	1"		•	•	•		
10"	1-1/4"			•	•	•	
12" x 2"	1-1/4"					•	
12" and 14"	1-1/2"					•	•

These size bushings shipped free of charge with your wheel order.





**TIER: GOOD**  
**TRADENAME: GEMINI ALUMINUM OXIDE**  
**ABRASIVE: Brown Aluminum Oxide**



**TIER: GOOD**  
**TRADENAME: 39C (GREEN) / 37C (GRAY)**  
**ABRASIVE: Silicon Carbide**



**TIER: GOOD**  
**TRADENAME: GEMINI SILICON CARBIDE**  
**ABRASIVE: Green Silicon Carbide**

SIZE (D x T x H)	MAX. RPM	MIN./STD. PKG.	SPEC	PART #	MIN./STD. PKG.	SPEC	PART #	MIN./STD. PKG.	SPEC	PART #
5 x 1/2 x 1	4,965	1/5	Medium 60/80	076607 <b>88202</b>						
	4,965	1/5	Fine 100/120	076607 <b>88201</b>						
5 x 3/4 x 1	4,965	1/5	Medium 60/80	076607 <b>88210</b>						
	4,965	1/5	Fine 100/120	076607 <b>88205</b>						
6 x 1/2 x 1	4,140	1/5	Medium 60/80	076607 <b>88225</b>				1/5	Medium 60	662528 <b>36571</b>
	4,140	1/5	Coarse 36/46	662528 <b>36132</b>				1/5	Fine 80	662528 <b>36572</b>
	4,140	1/5	Fine 100/120	662528 <b>36133</b>				1/5	Extra Fine 120	662528 <b>36573</b>
6 x 3/4 x 1	4,140	1/5	Coarse 36/46	076607 <b>88245</b>				1/5	Medium 60	662528 <b>37190</b>
	4,140	1/5	Medium 60/80	076607 <b>88240</b>				1/5	Fine 80	662528 <b>37191</b>
	4,140	1/5	Fine 100/120	076607 <b>88235</b>				1/5	Extra Fine 120	662528 <b>37192</b>
6 x 1 x 1	4,140	1/5	Coarse 36/46	076607 <b>88260</b>				1/5	Medium 60	662528 <b>37187</b>
	4,140	1/5	Medium 60/80	076607 <b>88255</b>				1/5	Fine 80	662528 <b>37193</b>
	4,140	1/5	Fine 100/120	076607 <b>88250</b>				1/5	Extra Fine 120	662528 <b>37194</b>
7 x 1 x 1	3,600	1/5	Coarse 36/46	076607 <b>88275</b>				1/5	Medium 60	662529 <b>42300</b>
	3,600	1/5	Medium 60/80	076607 <b>88270</b>				1/5	Fine 80	662529 <b>42301</b>
	3,600	1/5	Fine 100/120	076607 <b>88265</b>				1/5	Extra Fine 120	662529 <b>42302</b>
8 x 3/4 x 1	3,600	1/5	Coarse 36/46	076607 <b>88278</b>						
	3,600	1/5	Medium 60/80	076607 <b>88277</b>						
	3,600	1/5	Fine 100/120	662530 <b>42317</b>						
8 x 1 x 1	3,600	1/5	Very Coarse 24	662530 <b>44454</b>				1/5	Medium 60	662530 <b>44087</b>
	3,600	1/5	Coarse 36/46	076607 <b>88286</b>				1/5	Fine 80	662530 <b>44534</b>
	3,600	1/5	Medium 60/80	076607 <b>88285</b>				1/5	Extra Fine 120	662530 <b>44535</b>
	3,600	1/5	Fine 100/120	076607 <b>88280</b>						
10 x 1 x 1-1/4	2,485	1/2	Very Coarse 24	662531 <b>60788</b>	1/5	39C60-IVK	662531 <b>16262</b>	1/2	Medium 60	662531 <b>44536</b>
	2,485	1/2	Coarse 36/46	076607 <b>88295</b>				1/2	Fine 80	662531 <b>60366</b>
	2,485	1/2	Medium 60/80	076607 <b>88290</b>						
	2,485	1/2	Fine 100/120	662531 <b>60350</b>						
10 x 1-1/4 x 1-1/4	2,485	1/2	Coarse 36/46	662531 <b>61250</b>						
	2,485	1/2	Medium 60/80	662531 <b>61251</b>						
10 x 1-1/2 x 1-1/4	2,485	1/2	Coarse 36/46	662531 <b>61393</b>	1/5	39C60-IVK	662531 <b>16265</b>			
	2,485	1/2	Medium 60/80	662531 <b>61395</b>						
12 x 1-1/2 x 1-1/2	2,070	1/2	Coarse 36/46	662532 <b>63052</b>						
	2,070	1/2	Medium 60/80	662532 <b>63053</b>						
12 x 2 x 1-1/4	2,070							1/2	Medium 60	662532 <b>63359</b>
	2,070							1/2	Fine 80	662532 <b>63360</b>
12 x 2 x 1-1/2	2,070	1/2	Very Coarse 24	662532 <b>63054</b>						
	2,070	1/2	Coarse 36/46	662532 <b>63055</b>						
	2,070	1/2	Medium 60/80	662532 <b>63056</b>	1/4	39C60-KVK	662532 <b>20942</b>			
14 x 2 x 1-1/2	1,800				1/3	37C24-RVK	662533 <b>19967</b>			
	1,800				1/3	39C60-JVK	662533 <b>19968</b>			

### Bench and Pedestal Wheel Arbor Bushings

WHEEL DIAMETER	WHEEL CENTER HOLE	1/2"	5/8"	3/4"	7/8"	1"	1-1/4"
5", 6", 7"	1"	•	•	•	•		
8"	1"		•	•	•		
10"	1-1/4"			•	•	•	
12" x 2"	1-1/4"					•	
12" and 14"	1-1/2"					•	•

*These size bushings shipped free of charge with your wheel order.*



Keep circular saws, band saws and other cutting tools razor sharp when you use the NorZon NZ ZA Type 01 sawgumming wheel. Featuring a resin bond to provide a smooth performance and deliver exceptional strength, this hardy wheel is specially designed for use in timber industries and for woodworking and saw manufacturing applications. Ideal for frequent use, the wheel has a zirconia alumina abrasive that ensures sharp cuts while it enhances the wheel's durability.

**Applications:** Tool Sharpening  
**Size Range:** 12"  
**Abrasive Grain:** Zirconia Alumina  
**Shape:** Type 01 Straight  
**Machine Used:**



Best choice for saw sharpening in the timber, woodworking, and saw manufacturing industries

## NORZON NZ ZIRCONIA ALUMINA

- Durable, sharp zirconia alumina abrasive delivering the highest performance under frequent use conditions
- Strong, yet smooth-running resin bond
- Designed to excel at shaping and resharpening various types of saws including large circular and band saw blades used primarily for timber harvesting

TIER: **BEST**  
 TRADENAME: **NORZON NZ**  
 ABRASIVE: Zirconia Alumina

SIZE (D x T x H)	MAX. RPM	STD. PKG.	SPEC	PART #
<b>Type 01 Straight</b>				
12 x 5/8 x 1-1/4	3,025	5	SG2981	662532 <b>62303</b>
12 x 3/4 x 1-1/4	3,025	5	SG2181	662532 <b>62305</b>
12 x 3/4 x 1-1/4	3,025	5	SG2981	662532 <b>62306</b>
12 x 3/4 x 1-1/4	3,025	5	SG2981	662532 <b>62307</b>
12 x 7/8 x 1-1/4	3,025	5	SG2981	662532 <b>62462</b>
12 x 7/8 x 1-1/4	3,025	5	SG2181	662532 <b>62461</b>
12 x 1 x 1-1/4	3,025	5	SG2981	662532 <b>62487 NS</b>

*NS Non-stock, Contact your Norton representative for current order quantities and lead-times.*



Used on surface, cylindrical, and tool and cutter grinders, Norton precision, form-holding vitrified toolroom wheels maximize your productivity. Available in latest-generation ceramic alumina, aluminum oxide, and silicon carbide – for every ferrous and non-ferrous MRO, small job shop, and production operation.

- Applications:** Surface grinding, tool and cutter grinding, and reshaping
- Shapes:** Type 01 Straight, Type 02 Cylinder, Type 05 and 07 Recessed 1 and 2 Sides, Type 06 and 11 Straight and Flaring Cups, Type 12 Dish, Type 20 Concaved 1 Side, and Type 35 Plate Mounted Disc
- Size Range:** 3/4" – 18" diameter
- Grit Range:** 46 – 220
- Abrasive Grain:** Ceramic Alumina, Aluminum Oxide, Silicon Carbide

### Material-to-Product Recommendation Guide

APPLICATION / MATERIAL	PERFORMANCE/PRODUCTIVITY								
	Narrow Contact Area			Medium Contact Area			Wide Contact Area		
	BEST	BETTER	GOOD	BEST	BETTER	GOOD	BEST	BETTER	GOOD
<b>Tool Resharpener</b>									
<b>Heavy Stock Removal (&gt; .004)</b>									
HSS & Tool Steel RC 50-68	5SG46-KVS	32A46-KVBE	38A46-KVBE	5SG46-JVS	32A46-JVBE	38A46-JVBE	5SG46-GVSP 3SGR46-GVP2	32A46-GVBEP 48A46-GVP2	38A46-GVBEP 38A46-GVP2
<b>Moderate Stock Removal (.002-.004)</b>									
HSS & Tool Steel RC 50-68	5SG60-KVS	32A60-KVBE	38A60-KVBE	5SG60-JVS	32A60-JVBE	38A60-JVBE	5SG60-GVSP 3SGR60-GVP2	32A60-GVBEP 48A60-GVP2	38A60-GVBEP
Carbide			39C60-JVK			39C60-JVK			
<b>Surface Grinding</b>									
<b>Heavy Stock Removal (&gt; .004)</b>									
HSS & Tool Steel RC 50-68	5NQ46-JVS	32A46-JVBE	38A46-JVBE	5SG46-IVS	32A46-IVBE	38A46-IVBE	5SG46-GVSP 3SGR46-GVP2	32A46-GVBEP 48A46-GVP2	38A46-GVBEP 38A46-GVP2
400 Series Stainless									
Soft Steels RC 30-45	5SG46-KVS	32A46-KVBE	38A46-KVBE	5SG46-JVS	32A46-JVBE	38A46-JVBE	5SG46-HVSP 3SGR46-HVP2	32A46-HVBEP 48A46-HVP2	38A46-HVBEP 38A46-HVP2
300 Series Stainless									
Cast Iron: Ductile & Gray	5SG46-KVS	32A46-KVBE	38A46-KVBE	5SG46-JVS	32A46-JVBE	38A46-JVBE	5SG46-HVSP 3SGR46-GVP2	32A46-HVBEP 48A46-HVP2	38A46-HVBEP 38A46-HVP2
Non-ferrous Alloys			39C46-JVK			39C46-IVK			
<b>Moderate Stock Removal (.002-.004)</b>									
HSS & Tool Steel RC 50-68	5NQ60-JVS	32A60-JVBE	38A60-JVBE	5SG60-IVS	32A60-IVBE	38A60-IVBE	5SG60-GVSP 3SGR60-GVP2	32A60-GVBEP 48A60-GVP2	38A60-GVBEP
400 Series Stainless									
Soft Steels RC 30-45	5SG60-KVS	32A60-KVBE	38A60-KVBE	5SG60-JVS	32A60-JVBE	38A60-JVBE	3SGR60-HVP2	32A60-HVBEP 48A60-HVP2	38A60-HVBEP 38A60-HVP2
300 Series Stainless									
Cast Iron: Ductile & Gray	5SG60-KVS	32A60-KVBE	38A60-KVBE	5SG60-JVS	32A60-JVBE	38A60-JVBE	3SGR60-HVP2	32A60-HVBEP 48A60-HVP2	38A60-HVBEP 38A60-HVP2
Non-ferrous Alloys			39C60-JVK			39C60-IVK			
<b>Light Stock Removal and Finishing (&lt;.001)</b>									
HSS & Tool Steel RC 50-68		32A80-JVBE	38A80-JVBE		32A80-IVBE	38A80-IVBE		32A80-HVBE	38A80-HVBE
400 Series Stainless									
Soft Steels RC 30-45		32A80-KVBE	38A80-KVBE		32A80-JVBE	38A80-JVBE		32A80-IVBE	38A80-IVBE
300 Series Stainless									
Cast Iron: Ductile & Gray		32A80-KVBE	38A80-KVBE		32A80-JVBE	38A80-JVBE		32A80-IVBE	38A80-IVBE
Nonferrous Alloys			39C80-JVK			39C80-IVK			39C80-HVK

### Upgrade to Vitrium<sup>3</sup> to improve your process and productivity in 3 ways

Vitrium<sup>3</sup> bond (VS3) wheels for enhanced-performance are available with these abrasives: NQ, SG, 32A, and 48A

<p><b>1. COOL CUTTING</b></p> <p>VITRIUM<sup>3</sup> BOND   BOND-PART INTERACTION</p> <p>Improved holding power (using less bond-to-abrasive ratio) exposes a larger grain surface area, improving freer cut rate.</p>	<p><b>2. PRECISE PROFILE</b></p> <p>VITRIUM<sup>3</sup> WHEEL AFTER 5 GRINDING CYCLES</p> <p>Superior grain-holding properties significantly improve wheel form and corner holding vs. other bond systems – reducing dressing time and dresser wear.</p>	<p><b>3. HIGH SPEED</b></p> <p>High Speed – Norton Vitrium<sup>3</sup> bond provides the ultimate wheel strength. This allows for high speed operation on equipment designed and rated for high speed.</p>
--	--	--

### Vitrified Wheel Bonds

Bond	Description
VS3	Quantum (white) and Norton SG (white): Patented technology produces a strong, exceptionally cool-cutting bond with unprecedented form holding; able to run at higher operating speed; increased throughput and productivity; versatile, for all areas of contact
VS3P	Quantum (white) Norton SG (white): Porous bond; use where heat is an issue; patented technology produces a strong, exceptionally cool-cutting bond with unprecedented form holding; versatile, for all areas of contact
VS	Quantum (green) and Norton SG (blue): High stock removal; narrow/medium contact area; roughing/finishing; cool cutting
VSP	Quantum (green) and Norton SG (blue): Porous bond; use where heat is an issue; high stock removal; medium/wide contact area; cool cutting; high chip clearance
VBE	32A (purple), 38A (white) and 57A (brown): General purpose; narrow/medium contact area; versatile; economical.
VBEP	32A (purple) and 38A (white): Porous bond; use where heat is an issue; medium/wide contact area; cool cutting; high chip clearance; high stock removal
V	38A (orange): For fine grit, form/corner holding applications; narrow contact area
VK	37C (black) and 39C (green): Designed specifically for silicon carbide abrasives; medium to narrow area of contact ; for non-steel applications
VCP	32A (purple) and 23A (blue/grey): Induced-pore, wide contact area, surface/creepfeed grinding applications
VP2	3SGR (ruby), 48A (ruby), 25A (pink) and 38A (white): Unique, controlled-porosity (NORPOR) bond for heat-sensitive applications

### TECH TIP

#### SELECTING A WHEEL WITH THE CORRECT BOND TYPE

- Use VBE, V, VS, VS3, and VK bonds for general purpose applications or medium contact areas.
- Use VBEP, VSP, VS3P, VCP, and VP2 bonds on wide contact areas where heat is an issue.



It is the user's responsibility to refer to and comply with ANSI B7.1

### Application/Grit Recommendation Guide

Grit	Requirement	Finish	Minimum Corner Radius
46	General Purpose	32 Ra and rougher	0.020"
60	Commercial Finish	32 Ra and better	0.016"
80 – 100	Fine Finish	20 Ra and better	0.0105"
120	Very Fine Finish	10 Ra and better	0.006"
150	Corner-Form Holding		0.005"
180	Corner-Form Holding		0.0035"
220	Corner-Form Holding		0.0026"

### Cross Reference Guide

NORTON	CAMEL	CINCINNATI	RADIAC	TYROLIT	WINTERTHUR
Quantum 5NQ	—	5M5B	—	—	—
3SGR	AS3	3BP	7BP, 8BP	—	—
5SG	SZA	5MSB	7BW, 8BW	—	—
25A	PA	12A	RAA	88A	57A
32A	AZ	4A, 12A, 29A, 32A	32A, WRA	90A	67A, 68A
38A	83A, WA, AZ (Blue)	9A, 10A, 11A, 82A	WA, 9A	88A, 89A	53A, 49A, 42A
48A	—	—	RA	91A	68A
53A	91A, DA	29A, 97A	43A, 45A, 97A, WPA	50A	61A, 64A
57A	94A, CGW, A	A, AK	A	A, 52A	A
37C	—	6C	C	1C	C
39C	—	5C	GC	C	11C

## Starting Recommendations for Truing and Dressing Norton Toolroom Wheels

### TRUING & DRESSING: DRESSING STICK STARTING RECOMMENDATIONS

Size/ Spec.	High Performance Stick Part #	Size/ Spec.	Conventional Stick Part #
3 x 1/2 x 1/4" Norbide	614636 <b>10148</b>	6 x 1 x 1" 37C24-SVK	614636 <b>10462</b>
		8 x 1 x 1" 37C24-SVK	614636 <b>10471</b>
Other sizes are available. See the Dressing Stick section.			

### DRESSING: SINGLE POINT DRESSING TOOL STARTING RECOMMENDATIONS

Wheel Sizes	Tool Shank Diameter	Ceramic (NQ, Norton SG, TG, Etc.), 37C & 39C Wheels	25A, 32A, 38A, 48A, 53A, 57A, 64A, 86A Wheels		
Product No.	Part #	Product No.	Part #		
Up to 7"	3/8	BCSG2M6	662601 <b>57007</b>	BC2M6	662601 <b>95000</b>
	7/16	BCSG2M7	662601 <b>56905</b>	BC2M7	662601 <b>95001</b>
8" to 10"	3/8	BCSG3M6	662601 <b>57008</b>	BC3M6	662601 <b>95002</b>
	7/16	BCSG3M7	662601 <b>56906</b>	BC3M7	662601 <b>95003</b>
12" to 14"	3/8	BCSG5M6	662601 <b>57009</b>	BC5M6	662601 <b>95004</b>
	7/16	BCSG5M7	662601 <b>56907</b>	BC5M7	662601 <b>95005</b>

These tools are a standard recommendation; see the "Diamond Tool" section for additional tools  
See the Fliesen Tool section for Furioso tools, engineered specifically for Quantum vitrified wheel dressing

## TECH TIP

### Wheel Dressing

#### Single Point Diamond Tools

- Rigidly mount Single Point tools at a 10°-15° angle to the wheel centerline with a line drawn through the center of the wheel, pointing in the direction of wheel travel
- Point of contact should be slightly below centerline of wheel
- Use coolant whenever possible
- Normal infeed is .001" per pass
- Lead selections range from .002" - .010" per wheel revolution
- Rotate the tool 1/4 turn periodically to maintain a sharp point
- Use VBE, V, VS, VK bonds for general purpose applications or medium contact areas.
- Use VBEP, VSP, VS3P, VCP, VP2 bonds on wide contact areas where heat is an issue.

#### Multi-Point Diamond Tools

- Most multi-point tools are used for straight face dressing
- Tool should have full face contact with the wheel
- With new tool, 3 to 5 passes at .005" per pass should be taken to expose diamonds
- Infeed per pass .001" - .002"
- Use coolant whenever possible
- Use appropriate lead (and traverse rate)

Contact your Norton representative for proper tool selection for Targa (TG) wheels



It is the user's responsibility to refer to and comply with ANSI B7.1

#### Dressing Ceramic Wheels

- Use our specially designed Norton SG diamond tools when dressing ceramic wheels
- When first using a Norton SG tool, make 3 to 5 passes at .005" infeed to ensure full face contact between the dressing tool and wheel face
- Reduce normal dressing infeed by half. Do not exceed infeed of .002" per pass.
- The lead selection should be between .006" - .030" per wheel revolution. Faster traverse with Norton SG tools generally provides an open wheel face that can maximize productivity of the ceramic abrasive.
- To optimize applications using ceramic abrasives and/or tools, normal dressing parameters must change. Reduce infeed by 25%. Significant reductions in the amount of infeed and frequency of dress will result in substantially lower cost per part ground.
- See the Fliesen Tool section for Furioso tools, engineered specifically for Quantum vitrified wheel dressing.



## Single-Pack Toolroom Wheels

### The Small Quantity Order Solution

Available in our most popular specification of BEST, BETTER and GOOD performance tiers. Norton single-pack toolroom wheels provide many opportunities:

- Test order small quantities of a variety of wheel specifications
- Display and safely store your most often used wheels
- No need to repackage small orders from bulk shipments
- Ensure your wheel arrives on site undamaged

## Troubleshooting Guide

Check the obvious first. Before changing the grinding wheel specification, investigate the following most common causes for most grinding problems:

1. Diamond dressing tool condition (check if worn or dull, rotate tool or replace if necessary)
2. Coolant direction, volume and filtration
3. Wheel dressing procedures (dress more open to free up cut rate, dress more closed to improve finish)

PROBLEM	POSSIBLE CAUSE	CORRECTION
Workpiece burn	Poor coolant direction	Redirect coolant into grinding zone
	Restricted or low coolant volume	Increase coolant volume
	Wheel too hard	Use one grade softer wheel
	Wheel structure too closed	Use porous bond wheel
	Wheel dressed too fine	Dress wheel coarser, more "open"
	Worn dressing tool	Inspect, rotate or replace dressing tool
	Work speed too slow	Increase work speed
	Infeed too fast	Reduce stock removed per pass or upgrade to 5SG or 5NQ
Wheel loading and glazing	Wheel too fine	Use coarser grit or softer grade wheel
	Wheel too hard	Use one grade softer wheel
	Too durable abrasive	Use a sharper, more friable abrasive
	Poor coolant quality	Change coolant or use high detergent type
	Wheel structure too closed	Use a porous bond wheel
	Wheel too finely dressed	Dress wheel very open
	Diamond dressing tool worn	Replace diamond and dress coarse (open)
Chatter	Depth of cut too small	Increase feed and traverse speed
	Unsupported work	Increase work support
	Machine vibration	Check for worn bearings
	Too heavy cut rate	Reduce cut rate
	Wheel too hard	Use one grade softer wheel
	Wheel structure too closed	Use a porous bond wheel
Chatter marks on workpiece	Wheel out of balance	Check wheel balance or try new wheel
	Worn spindle bearings	Check and correct for truth and end play
	Wheel out of truth	Redress wheel and check mounting
	Poorly clamped wheel	Check tightness of mounting nuts
Poor surface finish	Glazed face of wheel	Redress wheel with sharp dressing tool
	Incorrect wheel dress	Dress wheel finer (slow down dressing tool traverse)
	Worn dressing tool	Inspect, rotate, or replace dressing tool
	Too coarse grit size	Use a finer grit size
Not holding form	Wheel too hard	Use softer grade
	Wheel too soft	Use one grade harder wheel
Not holding corner	Wheel structure too open	Use a more closed wheel structure
	Incorrect wheel dress	Dress wheel finer. Face and side true wheel.
	Too large grit size	Use smaller grit size (maximum grit diameter less than 1.5 times corner radius)
	Wheel too soft	Use harder grade wheel
	Wheel structure too open	Use more closed structure wheel

Best choice for versatility, maximum performance and cost savings



## QUANTUM (5NQ) CERAMIC ALUMINA

- Revolutionary, proprietary, engineered ceramic grain shape and chemistry for all low-, medium- and high-force applications ranging from cast iron, to stainless steel, and hard-to-grind Inconel and titanium
- Proven tough vitrified bond stands up to extreme grinding forces; perform well on old and new CNC cutting tool, cylindrical and surface grinding machines
- 33% to 100% longer life, 30% higher MRR (material removal rate), and 15% lower threshold power versus competitive ceramic products

Best choice for high productivity, low total per-part grinding cost



## SG CERAMIC ALUMINA

- Exceptionally high-performance ceramic alumina and friable aluminum oxide abrasive blend for fast stock removal, cool, superior cutting; 3 - 5 times more life than aluminum oxide wheels; double rough stock removal rate versus conventional abrasives
- High performance bond for versatility (for grinding high speed tool steels, hardened and soft steels, and aerospace alloys) and exceptional form holding
- Self-sharpening abrasive minimizes burn and dressing to maximize sharp edge on tools and dies for longer life in production

Better choice for medium-to-heavy stock removal



## 32A ALUMINUM OXIDE

- Strong, sharp monocrystalline aluminum oxide grain, ideal for precision production medium-to-heavy stock removal applications
- The most versatile vitrified bond, especially recommended for CNC cutting tool machines, and cylindrical and surface grinding
- Grinds with an exceptional cool, fast cutting action, requires minimum dressing

Good choice for light grinding of tool steel



## 38A ALUMINUM OXIDE

- Friable aluminum oxide abrasive for cool and burn-free cutting toolroom applications with light-to-moderate feed rates
- The most versatile vitrified bond, especially recommended for CNC cutting tool machines, and cylindrical and surface grinding applications on hard and very heat-sensitive high-speed tool steels; cool fast cutting
- Consistent quality for excellent balance and dimensional accuracy time after time

Good choice for use on general-purpose applications; economical



## GEMINI ALUMINUM OXIDE

- Specially blended aluminum oxide abrasive for many surface and cylindrical grinding applications
- Durable vitrified bond for high stock removal on narrow to medium contact areas
- Good general-purpose choice when a broad range of parts are ground on one machine

Vitrified Wheels For Steel Applications



TIER: <b>BEST</b>	TIER: <b>BETTER</b>	TIER: <b>GOOD</b>
TRADENAME: <b>QUANTUM / NORTON SG</b>	TRADENAME: <b>32A</b>	TRADENAME: <b>38A</b>
ABRASIVE: Ceramic Alumina	ABRASIVE: Aluminum Oxide	ABRASIVE: Aluminum Oxide

SIZE (D x T x H)	MAX. RPM	MIN./STD. PKG.	SPEC.	PART #	SPEC.	PART #	MIN./STD. PKG.	SPEC.	PART #
<b>Type O1 Straight</b>									
2 x 1/2 x 3/8	16,235	10/50			32A60-KVBE	662434 <b>28214</b>			
3 x 1/4 x 1/2	10,825	10/50			32A60-KVBE	662435 <b>28696</b>			
3 x 1/2 x 3/8	10,825	10/50			32A60-KVBE	662435 <b>28825</b>	10/50	38A60-JVBE	662435 <b>29032</b>
3 x 1/2 x 1/2	10,825	10/50			32A60-KVBE	662435 <b>28828</b>			
3 x 1 x 1/2	10,825						10/10	38A60-MVBE	662435 <b>29145</b>
	10,825						10/10	38A80-MVBE	662435 <b>29146</b>
4 x 1/4 x 1/2	8,120	1/10			32A60-KVBE	662435 <b>29532</b>	1/10	38A60-KVBE	662435 <b>29777</b>
	8,120						1/10	38A100-IVBE	662435 <b>29782</b>
4 x 1/4 x 3/4	8,120	1/10			32A60-KVBE	662435 <b>29736</b>			
4 x 1/2 x 1/2	8,120						1/10	38A60-KVBE	662435 <b>29947</b>
	8,120						1/10	38A100-KVBE	662435 <b>29954</b>
4 x 1/2 x 3/4	8,120	1/10			32A60-KVBE	662435 <b>29849</b>	1/10	38A60-KVBE	662435 <b>29961</b>
	8,120	1/10			32A80-KVBE	662435 <b>29850</b>			
4 x 1 x 1/2	8,120						1/10	38A60-MVBE	662435 <b>30126</b>
6 x 1/8 x 1-1/4	4,140	1/10			32A80-KVBE	662528 <b>35361</b>	1/10	38A150-LVBE	662528 <b>35506</b>
6 x 1/4 x 1/2	4,140	1/10			32A60-KVBE	662528 <b>35784</b>			
6 x 1/4 x 1-1/4	4,140	1/10			32A60-KVBE	662528 <b>35786</b>	1/10	38A60-KVBE	662528 <b>35803</b>
	4,140						1/10	38A80-KVBE	662528 <b>35807</b>
	4,140						1/10	38A150-KV	662528 <b>35759</b>
6 x 1/2 x 1/2	4,140	1/10			32A60-KVBE	662528 <b>36394</b>	1/10	38A60-KVBE	662528 <b>36530</b>
	4,140						1/10	38A80-KVBE	662528 <b>36548</b>
6 x 1/2 x 1-1/4	4,140	1/10			32A46-KVBE	662528 <b>36380</b>	1/10	38A46-KVBE	662528 <b>36520</b>
	4,140	1/10	5SG60-KVS	662528 <b>03344</b>	32A60-KVBE	662528 <b>36396 B</b>	1/10	38A60-KVBE	662528 <b>36533</b>
	4,140	1/10			32A80-JVBE	662528 <b>36405</b>	1/10	38A80-KVBE	662528 <b>36550</b>
	4,140						1/10	38A120-KVBE	662528 <b>36664</b>
6 x 3/4 x 1/2	4,140	1/10			32A60-KVBE	662528 <b>37420</b>			
6 x 3/4 x 5/8	4,140						1/10	38A60-KVBE	662528 <b>37444</b>
6 x 3/4 x 1-1/4	4,140	1/10			32A60-KVBE	662528 <b>37421</b>	1/10	38A60-KVBE	662528 <b>37445</b>
6 x 1 x 1-1/4	4,140	1/10			32A60-KVBE	662528 <b>37921 B</b>			
7 x 1/8 x 1-1/4	3,275	1/10			32A60-IVBE	662529 <b>39112</b>	1/10	38A80-IVBE	662529 <b>39219</b>
	3,600						1/10	38A100-KVBE	662529 <b>39223</b>
7 x 1/4 x 1-1/4	3,600	1/10			32A46-HVBE	662529 <b>39543</b>	1/10	38A46-HVBE	662529 <b>39690</b>
	3,600	1/10	5NQ46-IVS3	662434 <b>95257</b>	32A46-IVBE	662529 <b>39544</b>	1/10	38A46-IVBE	662529 <b>39691</b>
	3,600	1/10	5NQ60-JVS	662532 <b>93579</b>	32A46-JVBE	662529 <b>39545</b>	1/10	38A46-JVBE	662529 <b>09755</b>
	3,600	1/10	5NQ60-JVS3	662434 <b>95258</b>	32A46-KVBE	662529 <b>39862</b>	1/10	38A60-HVBE	662529 <b>39695</b>
	3,600	1/10	5SG46-IVS	662529 <b>40207 B</b>	32A60-HVBE	662529 <b>39547</b>	1/10	38A60-IVBE	662529 <b>39696</b>
	3,600	1/10			32A60-IVBE	662529 <b>39548 B</b>	1/10	38A60-JVBE	662529 <b>39698</b>
	3,600	1/10	5SG60-IVS	662529 <b>39459 B</b>	32A60-IVBE	662532 <b>88569 S</b>	1/10	38A60-KVBE	662529 <b>39700</b>
	3,600	1/10			32A60-JVBE	662529 <b>39549 B</b>	1/10	38A80-HVBE	662529 <b>39707</b>
	3,600	1/10			32A60-KVBE	662529 <b>39552 B</b>	1/10	38A80-IVBE	662529 <b>39808</b>
	3,600	1/10	5SG60-JVS	662529 <b>39460</b>	32A60-KVBE	662532 <b>88570 S</b>	1/10	38A80-JVBE	662529 <b>39809</b>
	3,600	1/10	5SG60-KVS	662529 <b>39461 B</b>			1/10	38A80-KVBE	662529 <b>39812</b>
	3,600	1/10			32A80-HVBE	662529 <b>39557</b>	1/10	38A100-IVBE	662529 <b>39823</b>
	3,600	1/10	5SG80-IVS	662529 <b>39462</b>	32A80-IVBE	662529 <b>39658 B</b>			
	3,600	1/10	5SG80-JVS	662529 <b>39463</b>	32A80-IVBE	662532 <b>88571 S</b>	1/10	38A100-JVBE	662529 <b>39826</b>
	3,600	1/10	5SG80-KVS	662529 <b>39464</b>	32A80-JVBE	662529 <b>39660 B</b>	1/10	38A100-KVBE	662529 <b>39827</b>
	3,600	1/10	5SG100-JVS	662529 <b>39467</b>	32A80-KVBE	662529 <b>39662 B</b>	1/10	38A100-LVBE	662529 <b>39830</b>
	3,600	1/10	5SG100-KVS	662529 <b>39468 B</b>	32A80-KVBE	662532 <b>88572 S</b>	1/10	38A120-JVBE	662529 <b>39833</b>
	3,600	1/10					1/10	38A120-KVBE	662529 <b>39834</b>
	3,600	1/10			32A100-IVBE	662529 <b>39670 B</b>	1/10	38A150-KVBE	662529 <b>39838</b>
	3,600	1/10			32A100-JVBE	662529 <b>39672</b>	1/10	38A150-LVBE	662529 <b>39839</b>
	3,600	1/10			32A100-IVBE	662532 <b>88573 S</b>	1/10	38A150-MV	662529 <b>39521</b>
	3,600	1/10			32A100-KVBE	662529 <b>39673 B</b>	1/10	38A220-KV	662529 <b>39528</b>
	3,600	1/10					1/10	38A220-LV	662529 <b>39529</b>
	3,600	1/10			32A120-IVBE	662529 <b>39680</b>	1/10	38A220-LVBE	662529 <b>39847</b>
	3,600	1/10			32A120-KVBE	662529 <b>39682</b>	1/10	38A220-MV	662529 <b>39530</b>
	3,600	1/10			32A220-LVBE	662529 <b>39689</b>			
7 x 3/8 x 1-1/4	3,600	1/10			32A60-KVBE	662529 <b>40276</b>	1/10	38A60-KVBE	662529 <b>40294</b>
	3,600	1/10			32A80-KVBE	662529 <b>40284</b>	1/10	38A80-IVBE	662529 <b>40297</b>

B Best Seller; performs well in a variety of applications for many satisfied customers  
S Single Pack

Continued



Vitrified Wheels For Steel Applications *continued*



TIER: **BEST** **QUANTUM / NORTON SG** **BETTER** **32A / 48A**  
 TRADENAME: Ceramic Alumina Aluminum Oxide  
 ABRASIVE:

**GOOD** **38A / 25A / GEMINI**  
 Aluminum Oxide

SIZE (D x T x H)	MAX. RPM	MIN./STD. PKG.	SPEC.	PART #	SPEC.	PART #	MIN./STD. PKG.	SPEC.	PART #
<b>Type O1 Straight</b>									
7 x 1/2 x 1-1/4	3,600	1/10	5NQ46-HVS3	662533 <b>75053</b>	32A46-FVBEP	662529 <b>41203</b>	1/10	25A46-HVP2	662529 <b>16219</b>
	3,600	1/10	5NQ46-IVS	69083 <b>159103</b>	32A46-GVBE	662529 <b>40862</b>	1/10	25A60-HVP2	662529 <b>16221</b>
	3,600	1/10	5NQ46-IVS3	662533 <b>75052</b>	32A46-GVBEP	662529 <b>41204 B</b>	1/10	38A46-GVBE	662529 <b>41022</b>
	3,600	1/10	5NQ46-JVS	69083 <b>159104</b>	32A46-HVBE	662529 <b>40863 B</b>	1/10	38A46-GVBEP	662529 <b>41323</b>
	3,600	1/10	5NQ60-GVSP	69083 <b>159105</b>	32A46-HVBE	662532 <b>88775 S</b>	1/10	38A46-HVBE	662529 <b>41023</b>
	3,600	1/10	5NQ60-IVS3	662533 <b>75047</b>	32A46-HVBEP	662529 <b>41205 B</b>			
	3,600	1/10	5NQ60-JVS	69083 <b>159106</b>	32A46-HVS3	662434 <b>94107</b>	1/10	38A46-HVBEP	662529 <b>41324</b>
	3,600	1/10	5NQ60-JVS3	662533 <b>75046</b>	32A46-IVBE	662529 <b>40864 B</b>	1/10	38A46-HVP2	662529 <b>16223</b>
	3,600	1/10	3SGP46-GVSP	662529 <b>11717</b>	32A46-IVBE	662532 <b>88776 S</b>	1/10	38A46-IVBE	662529 <b>41024</b>
	3,600	1/10	3SGR46-HVP2	662529 <b>16211</b>	32A46-IVBEP	662529 <b>41206</b>	1/10	38A46-JVBE	662529 <b>41026</b>
	3,600	1/10	3SGR60-HVP2	662529 <b>16213</b>	32A46-IVS3	662434 <b>95357</b>	1	38A46-JVBE	662532 <b>88767 S</b>
	3,600	1/10	5SG46-GVSP	662529 <b>40522</b>	32A46-JVBE	662529 <b>40865 B</b>	1/10	38A46-KVBE	662529 <b>41028</b>
	3,600	1/10	5SG46-HVS3	662533 <b>75050</b>	32A46-JVBE	662532 <b>88777 S</b>	1/10	38A60-HVBE	662529 <b>41035</b>
	3,600	1/10	5SG46-HVSP	662529 <b>41130</b>			1/10	38A60-HVBEP	662529 <b>41330</b>
	3,600	1/10	5SG46-IVS	662529 <b>40193 B</b>	32A46-KVBE	662529 <b>40867 B</b>	1/10	38A60-IVBE	662529 <b>41036</b>
	3,600	1/10	5SG46-IVS	662532 <b>88788 S</b>			1/10	38A60-JVBE	662529 <b>41038</b>
	3,600	1/10			32A54-IVBE	662529 <b>40873</b>	1	38A60-JVBE	662532 <b>88766 S</b>
	3,600	1/10	5SG46-IVSP	662529 <b>40523</b>	32A60-GVBEP	662529 <b>41313</b>	1/10	38A60-KVBE	662529 <b>41041</b>
	3,600	1/10	5SG46-JVS	662529 <b>40194 B</b>	32A60-HVBE	662529 <b>40879 B</b>	1	38A60-KVBE	662532 <b>88769 S</b>
	3,600	1/10	5SG46-JVS	662532 <b>88789 S</b>	32A60-HVBEP	662529 <b>41314</b>	1/10	38A60-LVBE	662529 <b>11677</b>
	3,600	1/10	5SG46-JVS3	662434 <b>95263</b>	32A60-IVBE	662529 <b>40880 B</b>	1/10	38A80-HVBE	662529 <b>41047</b>
	3,600	1/10	5SG46-KVS	662529 <b>40195</b>	32A60-IVBE	662532 <b>88779 S</b>	1/10	38A80-IVBE	662529 <b>41048</b>
	3,600	1/10	5SG60-GVSP	662529 <b>40524</b>	32A60-IVS3	662434 <b>95363</b>	1/10	38A80-JVBE	662529 <b>41049</b>
	3,600	1/10	5SG60-IVS	662529 <b>40196 B</b>	32A60-JVBE	662529 <b>40882 B</b>	1/10	38A80-KVBE	662529 <b>41054</b>
	3,600	1/10			32A60-JVBEP	662529 <b>41316</b>	1	38A80-KVBE	662533 <b>50641 S</b>
	3,600	1/10			32A60-JVS3	662434 <b>95364</b>	1/10	38A80-LVBE	662529 <b>41056</b>
	3,600	1/10	5SG60-IVSP	662529 <b>40525</b>	32A60-KVBE	662529 <b>40885 B</b>	1/10	38A100-IVBE	662529 <b>41163</b>
	3,600	1/10	5SG60-JVS	662529 <b>40197 B</b>	32A60-KVBE	662532 <b>88782 S</b>	1/10	38A100-JVBE	662529 <b>41165</b>
	3,600	1/10			32A60-LVBE	662529 <b>40888</b>	1/10	38A100-KVBE	662529 <b>41168</b>
	3,600	1/10	5SG60-JVS3	662533 <b>75043</b>	32A80-HVBE	662529 <b>40894</b>	1/10	38A120-JVBE	662529 <b>41174</b>
	3,600	1/10	5SG60-KVS	662529 <b>40198</b>	32A80-IVBE	662529 <b>40895 B</b>	1/10	38A120-KVBE	662529 <b>41175</b>
	3,600	1/10	5SG60-LVS	662529 <b>40199</b>	32A80-IVBE	662532 <b>88783 S</b>	1/10	38A150-JVBE	662529 <b>41179</b>
	3,600	1/10	5SG80-IVS	662529 <b>40200</b>	32A80-JVBE	662529 <b>40897 B</b>	1/10	38A150-MV	662529 <b>40595</b>
	3,600	1/10	5SG80-IVSP	662529 <b>40527</b>	32A80-KVBE	662529 <b>40899 B</b>	1/10	38A220-QV	662529 <b>40605</b>
	3,600	1/10	5SG80-JVS	662529 <b>40201 B</b>	32A80-KVBE	662532 <b>88784 S</b>			
	3,600	1/10			32A80-LVBE	662529 <b>40900</b>	10/10	Gemini 46-I	662532 <b>46800</b>
	3,600	1/10	5SG80-KVS	662529 <b>40202</b>	32A100-IVBE	662529 <b>40907</b>	10/10	Gemini 46-J	662532 <b>46802</b>
	3,600	1/10	5SG80-LVS	662529 <b>40203</b>	32A100-JVBE	662529 <b>41008</b>			
	3,600	1/10	5SG100-JVS	662529 <b>40204</b>	32A120-LVBE	662529 <b>41018 B</b>			
	3,600	1/10	5SG100-KVS	662529 <b>40205</b>	32A120-LVBE	662532 <b>88786 S</b>			
	3,600	1/10			48A46-HVP2	662529 <b>16215 B</b>	10/10	Gemini 60-K	662532 <b>46821</b>
	3,600	1/10			48A60-HVP2	662529 <b>16217 B</b>			
	3,600	1/10			32A60-IVBE	662529 <b>41762</b>			
7 x 5/8 x 1-1/4	3,600	1/10	5SG46-IVS	662529 <b>42304</b>	32A46-GVBEP	662529 <b>42070</b>	1/10	38A46-HVBE	662529 <b>41950</b>
7 x 3/4 x 1-1/4	3,600	1/10	5SG46-KVS	662529 <b>42305</b>	32A46-HVBE	662529 <b>41930</b>	1/10	38A46-KVBE	662529 <b>41954</b>
	3,600	1/10	5SG60-JVS	662529 <b>42307</b>	32A46-IVBE	662529 <b>41931</b>	1/10	38A60-IVBE	662529 <b>42207</b>
	3,600	1/10	5SG60-KVS	662529 <b>42308</b>	32A46-KVBE	662529 <b>41935</b>	1/10	38A60-KVBE	662529 <b>42060</b>
	3,600	1/10			32A60-IVBE	662529 <b>41938</b>			
	3,600	1/10			32A60-KVBE	662529 <b>41943</b>			
	3,600	1/10			32A80-IVBE	662529 <b>41946</b>			
7 x 1 x 1-1/4	3,600	1/10	5SG60-JVS	662529 <b>42429</b>	32A46-HVBE	662529 <b>42513</b>	1/10	38A46-HVBE	662529 <b>42534</b>
	3,600	1/10	5SG60-KVS	662529 <b>42430</b>	32A46-JVBE	662529 <b>42268</b>			
	3,600	1/10			32A60-IVBE	662529 <b>42524</b>			
	3,600	1/10			32A60-KVBE	662529 <b>42709</b>			

B Best Seller; performs well in a variety of applications for many satisfied customers  
 S Single Pack

For non-stock toolroom wheels: if you don't see the toolroom wheel you need in our stock listing, call your local authorized Norton distributor to check our made-to-order non-stock availability – including our revolutionary new Quantum ceramic and Vitrium<sup>3</sup> bond wheels.

## Vitrified Wheels For Steel Applications *continued*



<b>TIER: BEST</b>	<b>TIER: BETTER</b>	<b>TIER: GOOD</b>
<b>TRADENAME: QUANTUM / NORTON SG</b>	<b>32A / 48A</b>	<b>38A / 25A / GEMINI</b>
<b>ABRASIVE: Ceramic Alumina</b>	<b>Aluminum Oxide</b>	<b>Aluminum Oxide</b>

SIZE (D x T x H)	MAX. RPM	MIN./STD. PKG.	SPEC.	PART #	SPEC.	PART #	MIN./STD. PKG.	SPEC.	PART #	
<b>Type O1 Straight</b>										
8 x 1/4 x 1-1/4	3,105 / 3,600*	1/10	5SG60-KVS	662530 <b>43351</b> *	32A46-HVBE	662530 <b>43412</b>	1/10	38A60-IVBE	662530 <b>43431</b> *	
	3,105 / 3,600*	1/10	5SG80-KVS	662530 <b>43353</b> *	32A46-IVBE	662530 <b>43310</b>	1/10	38A60-JVBE	662530 <b>43432</b> *	
	3,600	1/10			32A46-KVBE	662530 <b>43413</b>	1/10	38A60-KVBE	662530 <b>10825</b>	
	3,600	1/10			32A60-IVBE	662530 <b>43416 B</b>	1/10	38A80-IVBE	662530 <b>43437</b>	
	3,600	1/10			32A60-IVBE	662532 <b>88796 S</b>	1/10	38A80-JVBE	662530 <b>43439</b>	
	3,600	1/10			32A60-JVBE	662530 <b>43417</b>	1/10	38A80-KVBE	662530 <b>43461</b>	
	3,600	1/10			32A60-KVBE	662530 <b>43399</b>	1/10	38A100-IVBE	662530 <b>43445</b>	
	3,600	1/10			32A80-IVBE	662530 <b>43421</b>	1/10	38A100-KVBE	662530 <b>43447</b>	
	3,600	1/10			32A80-KVBE	662530 <b>43458 B</b>	1/10	38A120-KVBE	662530 <b>43450</b>	
	3,600	1/10			32A80-KVBE	662532 <b>88797 S</b>	1/10	38A150-KVBE	662530 <b>43451</b>	
	3,600	1/10			32A80-LVBE	662530 <b>43425</b>				
	3,600	1/10			32A100-IVBE	662530 <b>43426</b>				
	3,600	1/10			32A100-KVBE	662530 <b>43428</b>				
	3,600	1/10			32A60-KVBE	662530 <b>43565</b>				
	8 x 3/8 x 1-1/4	3,600	1/10			32A60-KVBE	662530 <b>43565</b>			
	8 x 1/2 x 1-1/4	3,105 / 3,600*	1/10	5NQ46-HVS3	662533 <b>87211</b>	32A46-GVBEP	662530 <b>43882 B</b>	1/10	25A46-HVP2	662530 <b>19354</b> *
3,105		1/10	5NQ46-IVS	690831 <b>59107</b>	32A46-HVBE	662530 <b>43712 B</b>	1/10	38A46-HVBE	662530 <b>43746</b>	
3,105		1/10	5NQ46-IVS3	662533 <b>87212</b>	32A46-HVBE	662532 <b>88800 S</b>				
3,105 / 3,600*		1/10	5NQ46-JVS	690831 <b>59108</b> *	32A46-HVBEP	662530 <b>43883</b> *† B	1/10	38A46-HVBEP	662530 <b>43891</b> †	
3,105		1/10					1/10	38A46-IVBE	662530 <b>43749</b>	
3,105 / 3,600*		1/10	5NQ60-GVSP	690831 <b>59109</b>			1/10	38A46-JVBE	662530 <b>43752</b> *	
3,105 / 3,600*		1/10	5NQ60-IVS3	662533 <b>87214</b> *	32A46-IVBE	662530 <b>43713 B</b>	1/10	38A46-KVBE	662530 <b>43762</b> *	
3,600		1/10	5NQ60-JVS	690831 <b>59110</b>			1/10	38A60-HVBE	662530 <b>43756</b>	
3,600		1/10	5NQ60-JVS3	662533 <b>87213</b>	32A46-JVBE	662530 <b>43715 B</b>	1/10	38A60-IVBE	662530 <b>43757</b>	
3,105 / 3,600*		1/10	3SGP46-HVSP	662530 <b>11505</b>	32A46-JVBE	662532 <b>88801</b> * S	1/10	38A60-JVBE	662530 <b>43858</b> *	
3,600		1/10	3SGP46-JVH	662530 <b>13796</b>	32A46-JVS3	662434 <b>95314</b>	1/10	38A60-KVBE	662530 <b>43861</b>	
3,600		1/10	3SGR46-GVP2	662530 <b>19345</b>	32A46-KVBE	662530 <b>43716 B</b>	1/10	38A80-IVBE	662530 <b>43866</b>	
3,600		1/10	3SGR46-HVP2	662530 <b>19346</b>			1/10	38A80-JVBE	662530 <b>13787</b>	
3,600		1/10	3SGR60-HVP2	662530 <b>19348</b>	32A60-GVBEP	662530 <b>43887</b> †	1/10	38A80-KVBE	662530 <b>43869</b>	
3,105 / 3,600*		1/10	5SG46-GVSP	662530 <b>43649</b>	32A60-HVBE	662530 <b>43724</b> *	1/10	38A100-KVBE	662530 <b>43877</b> *	
3,600		1/10			32A60-HVBEP	662530 <b>43888</b>	10/10	Gemini 46-H	662532 <b>46841</b> *	
3,105 / 3,600*		1/10	5SG46-HVSP	662530 <b>43915</b> *†	32A60-IVBE	662530 <b>43725</b> * B	10/10	Gemini 46-I	662532 <b>46843</b>	
3,105 / 3,600*		1/10	5SG46-IVS	662530 <b>44089 B</b>	32A60-IVBE	662532 <b>88802</b> * S	10/10	Gemini 46-J	662532 <b>46845</b> *	
3,105 / 3,600*		1/10	5SG46-IVS	662532 <b>88804 S</b>	32A60-JVBE	662530 <b>43727</b> * B				
3,105 / 3,600*		1/10	5SG46-IVS3	662533 <b>87221</b>	32A60-KVBE	662530 <b>43729</b> * B				
3,105 / 3,600*		1/10	5SG46-IVSP	662530 <b>43650</b>	32A60-KVBE	662532 <b>88803</b> * S				
3,600		1/10	5SG46-JVS	662530 <b>44090 B</b>	32A80-HVBE	662530 <b>43733</b>				
3,600		1/10	5SG46-JVS	662532 <b>88806 S</b>	32A80-IVBE	662530 <b>43734</b>				
3,600		1/10	5SG46-KVS	662530 <b>44091</b>	32A80-JVBE	662530 <b>43736</b>				
3,600		1/10	5SG60-GVSP	662530 <b>43651</b> †	32A80-KVBE	662530 <b>43737</b>				
3,600		1/10	5SG60-IVS	662530 <b>44092</b>	32A100-IVBE	662530 <b>43740</b>				
3,600		1/10	5SG60-IVS3	662533 <b>87225</b>	32A100-KVBE	662530 <b>43742</b>				
3,600		1/10	5SG60-IVSP	662530 <b>43652</b>	48A46-HVP2	662530 <b>19350 B</b>				
3,600		1/10	5SG60-JVS	662530 <b>44093 B</b>						
3,600		1/10	5SG60-KVS	662530 <b>44094</b>						
3,600		1/10	5SG80-JVS	662530 <b>44096</b>						
3,600		1/10	5SG80-KVS	662530 <b>44097</b>						
3,600		1/10	5SG100-KVS	662530 <b>19435</b>						

B Best Seller; performs well in a variety of applications for many satisfied customers

S Single Pack

\* Indicates wheel max RPM has been tested to 3,600 as explained in the tech tip below

Continued

### TECH TIP

\* 8" Type O1 and Type O5 Vitrified Toolroom Wheels' Maximum Operating Speeds:

- Stock NorPor VP2 wheels = 3,600 RPMs
- All other 46 grit, J grade and harder = 3,600 RPMs
- All other 54 grit, I grade and harder = 3,600 RPMs
- All other 60 grit and finer, H grade and harder = 3,600 RPMs
- † Exceptions to the rule: speed-tested to 3,600 RPM
- All other specifications = 3,105 RPMs



It is the user's responsibility to refer to and comply with ANSI B7.1

## Vitrified Wheels For Steel Applications *continued*



<b>TIER: BEST</b>	<b>TIER: BETTER</b>	<b>TIER: GOOD</b>
<b>TRADENAME: QUANTUM / NORTON SG</b>	<b>TRADENAME: 32A / 48A</b>	<b>TRADENAME: 38A / 57A</b>
<b>ABRASIVE: Ceramic Alumina</b>	<b>ABRASIVE: Aluminum Oxide</b>	<b>ABRASIVE: Aluminum Oxide</b>

SIZE (D x T x H)	MAX. RPM	MIN./STD. PKG.	SPEC.	PART #	SPEC.	PART #	MIN./STD. PKG.	SPEC.	PART #
<b>Type O1 Straight</b>									
8 x 3/4 x 1-1/4	3,105	1/10	5NQ46-IVS	690831 <b>59111</b>	32A46-GVBEP	662530 <b>44195</b>	1/10	38A46-HVBE	662530 <b>44175</b>
	3,105	1/10	5NQ46-IVS3	66243 <b>494089</b>	32A46-HVBE	662530 <b>44159</b>	1/10	38A46-IVBE	662530 <b>44177</b>
	3,600	1/10	5NQ46-JVS	690831 <b>59112</b>	32A46-HVBEP	662530 <b>44196</b> †	1/10	38A46-KVBE	662530 <b>44180</b>
	3,105 / 3,600*	1/10	5NQ46-JVS3	66243 <b>494090</b> *	32A46-IVBE	662530 <b>44215</b>	1/10	38A60-IVBE	662530 <b>44184</b> *
	3,105 / 3,600*	1/10	5NQ60-GVS3P	66243 <b>495369</b>	32A46-JVBE	662530 <b>44161</b> *			
	3,105 / 3,600*	1/10	5NQ60-GVSP	690831 <b>59113</b>	32A46-KVBE	662530 <b>44165</b> *			
	3,600	1/10	5NQ60-JVS	690831 <b>59114</b>	32A60-GVBEP	662530 <b>44198</b>			
	3,600	1/10			32A60-HVBE	662530 <b>44168</b>			
	3,105 / 3,600*	1/10	5SG46-IVS	662530 <b>44098</b>	32A60-IVBE	662530 <b>44169</b> *			
	3,600	1/10	3SGP46-JVH	662530 <b>13792</b>	32A60-JVBE	662530 <b>44171</b>			
	3,600	1/10	5SG46-JVS	662530 <b>44099</b> B	32A60-KVBE	662530 <b>44173</b>			
	3,600	1/10			32A80-KVBE	662530 <b>44064</b>			
	3,600	1/10	5SG60-IVS	662530 <b>44101</b>					
	3,600	1/10	5SG60-JVS	662530 <b>44102</b>					
	3,600	1/10	5SG60-KVS	662530 <b>44103</b>					
8 x 1 x 1-1/4	3,105 / 3,600*	1/10	5SG46-KVS	662530 <b>02588</b> *	32A46-HVBE	662530 <b>44616</b>	1/10	38A46-IVBE	662530 <b>44636</b>
	3,105 / 3,600*	1/10	5SG60-GVSP	662530 <b>03228</b> †	32A46-IVBE	662530 <b>44617</b>	1/10	38A60-IVBE	662530 <b>44456</b> *
	3,600	1/10	5SG60-IVS	662530 <b>02639</b>	32A46-KVBE	662530 <b>44622</b>	1/10	57A60-MVBE	662530 <b>44270</b>
	3,600	1/10			32A60-IVBE	662530 <b>44624</b>			
	3,600	1/10			32A60-KVBE	662530 <b>44629</b>			
10 x 1/4 x 3	2,485					1	38A80-KVBE	662531 <b>49572</b>	
10 x 1/2 x 3	2,485	1			32A60-JVBE	662531 <b>49729</b>	1	38A60-KVBE	662531 <b>49859</b>
	2,485						1	38A80-KVBE	662531 <b>49865</b>
10 x 3/4 x 3	2,485	1			32A46-IVBE	662531 <b>60024</b>	1	38A46-JVBE	662531 <b>60158</b>
	2,485	1			32A60-IVBE	662531 <b>60137</b>	1	38A60-IVBE	662531 <b>60163</b>
	2,485	1			32A60-KVBE	662531 <b>60143</b>			
10 x 1 x 1-1/4	2,485	1			32A60-KVBE	662531 <b>60774</b>			
10 x 1 x 2	2,485	1			32A46-IVBE	662531 <b>60749</b>			
10 x 1 x 3	2,485	1	5SG46-GVSP	662531 <b>60494</b>	32A46-HVBE	662531 <b>60747</b>	1	38A46-IVBE	662531 <b>60889</b>
	2,485	1	5SG46-IVS	662531 <b>60400</b>	32A46-IVBE	662531 <b>60750</b>	1	38A46-JVBE	662531 <b>60892</b>
	2,485	1	5SG46-JVS	662531 <b>60401</b>	32A46-JVBE	662531 <b>60754</b>	1	38A60-IVBE	662531 <b>60898</b>
	2,485	1			32A46-KVBE	662531 <b>60758</b>	1	38A60-KVBE	662531 <b>60900</b>
	2,485	1	5SG46-KVS	662531 <b>60402</b>	32A60-IVBE	662531 <b>60769</b>			
	2,485	1	5SG60-GVSP	662531 <b>60495</b>	32A60-KVBE	662531 <b>60777</b>			
	2,485	1	5SG60-IVS	662531 <b>60403</b>	32A80-KVBE	662531 <b>60782</b>			
	2,485	1	5SG60-JVS	662531 <b>60404</b>					
	2,485	1	5SG60-KVS	662531 <b>60405</b>					
12 x 1/2 x 3	2,070	2			32A60-JVBE	662532 <b>62134</b>			
	2,070	2			32A80-KVBE	662532 <b>62110</b>			
12 x 1/2 x 5	2,070	2			32A60-KVBE	662532 <b>62107</b>			
	2,070	2			32A80-KVBE	662532 <b>62111</b>			
	2,070	2							
12 x 3/4 x 3	2,070	1	5SG46-IVS	662532 <b>62204</b>	32A46-GVBEP	662532 <b>62392</b>	1	38A46-JVBE	662532 <b>62281</b>
	2,070	1			32A46-HVBE	662532 <b>62260</b>			
	2,070	1			32A46-IVBE	662532 <b>62261</b>			
	2,070	1			32A60-IVBE	662532 <b>62270</b>			
	2,070	1			32A60-KVBE	662532 <b>62273</b>			
12 x 1 x 1-1/4	2,070	1			32A46-KVBE	662532 <b>62570</b>			

B Best Seller; performs well in a variety of applications for many satisfied customers

S Single Wheel Pack

\* Indicates wheel max RPM has been tested to 3,600 as explained in the tech tip below

### TECH TIP

\* 8" Type O1 and Type O5 Vitrified Toolroom Wheels' Maximum Operating Speeds:

- Stock NorPor VP2 wheels = 3,600 RPMs
- All other 46 grit, J grade and harder = 3,600 RPMs
- All other 54 grit, I grade and harder = 3,600 RPMs
- All other 60 grit and finer, H grade and harder = 3,600 RPMs
- † Exceptions to the rule: speed-tested to 3,600 RPM
- All other specifications = 3,105 RPMs



It is the user's responsibility to refer to and comply with ANSI B7.1

## Vitrified Wheels For Steel Applications *continued*



TIER:	BEST	BETTER	GOOD
TRADENAME:	QUANTUM / NORTON SG	32A / 48A	38A
ABRASIVE:	Ceramic Alumina	Aluminum Oxide	Aluminum Oxide

SIZE (D x T x H)	MAX. RPM	MIN./STD. PKG.	SPEC.	PART #	SPEC.	PART #	MIN./STD. PKG.	SPEC.	PART #	
<b>Type O1 Straight</b>										
12 x 1 x 3	2,070 / 2,710*	1	3SGR46-HVP2	662532 <b>20885*</b>	32A46-GVBEP	662532 <b>62840</b>	1	38A46-HVBE	662532 <b>62700</b>	
	2,070	1	5SG46-HVSP	662532 <b>62488</b>	32A46-HVBE	662532 <b>62562</b>	1	38A46-IVBE	662532 <b>62702</b>	
	2,070	1	5SG46-IVS	662532 <b>62500</b>	32A46-HVBEP	662532 <b>62842</b>	1	38A46-JVBE	662532 <b>62704</b>	
	2,070	1	5SG46-JVS	662532 <b>62501</b>	32A46-IVBE	662532 <b>62564</b>	1	38A60-IVBE	662532 <b>62713</b>	
	2,070	1	5SG46-JVS3	662434 <b>95317</b>	32A46-JVBE	662532 <b>62567</b>				
	2,070	1	5SG46-KVS	662532 <b>62502</b>	32A46-KVBE	662532 <b>62572</b>				
	2,070	1	5SG46-KVS3	662434 <b>95318</b>	32A60-HVBE	662532 <b>62580</b>				
	2,070	1	5SG60-GVSP	662532 <b>62593</b>	32A60-IVBE	662532 <b>62581</b>				
	2,070	1	5SG60-IVS	662532 <b>62503</b>	32A60-KVBE	662532 <b>62689</b>				
	2,070	1	5SG60-JVS	662532 <b>62504</b>	32A80-KVBE	662532 <b>62532</b>				
	2,070 / 2,710*	1	5SG60-KVS	662532 <b>62505</b>	48A60-HVP2	662532 <b>20891*</b>				
	12 x 1 x 5	2,070	1	5SG46-GVSP	662532 <b>62594</b>	32A46-GVBEP	662532 <b>62841</b>	1	38A46-IVBE	662532 <b>62703</b>
		2,070	1	5SG46-IVS	662532 <b>62508</b>	32A46-HVBE	662532 <b>62563</b>	1	38A60-KVBE	662532 <b>62719</b>
		2,070	1	5SG46-JVS	662532 <b>62509 B</b>	32A46-IVBE	662532 <b>62565</b>			
2,070		1	5SG46-KVS	662532 <b>62510</b>	32A46-KVBE	662532 <b>62573</b>				
2,070		1	5SG60-GVSP	662532 <b>62595</b>						
2,070		1	5SG60-IVS	662532 <b>62511</b>	32A60-IVBE	662532 <b>62582</b>				
2,070		1	5SG60-JVS	662532 <b>62512</b>	32A60-JVBE	662532 <b>62686</b>				
2,070		1	5SG60-KVS	662532 <b>62513</b>	32A60-KVBE	662532 <b>62691 B</b>				
2,070		1	5SG80-JVS	662532 <b>62515</b>	32A80-JVBE	662532 <b>62696</b>				
2,070		1			32A80-KVBE	662532 <b>62697</b>				
12 x 1-1/4 x 3	2,070	1			32A46-IVBE	662532 <b>62301</b>				
12 x 1-1/2 x 1-1/4	2,070	1			32A46-KVBE	662532 <b>63146</b>				
12 x 1-1/2 x 3	2,070	1	5SG46-IVS	662532 <b>02820</b>	32A46-HVBE	662532 <b>63143</b>				
	2,070	1			32A46-IVBE	662532 <b>63144</b>				
	2,070	1			32A60-JVBE	662532 <b>63123</b>				
12 x 1-1/2 x 5	2,070	1	5NQ46-IVS	690831 <b>159115</b>	32A46-GVBEP	662532 <b>63192</b>	1	38A46-IVBE	662532 <b>14987</b>	
	2,070	1	5NQ46-IVS3	662434 <b>94092</b>	32A46-HVBE	662532 <b>63128</b>				
	2,070	1	5NQ46-JVS	690831 <b>159116</b>	32A46-IVBE	662532 <b>63145</b>				
	2,070	1	5NQ46-JVS3	662434 <b>94093</b>	32A46-JVBE	662532 <b>63120</b>				
	2,070	1	5NQ60-GVSP	690831 <b>159117</b>	32A60-HVBE	662532 <b>63149</b>				
	2,070	1	5NQ60-JVS	690831 <b>159118</b>	32A60-KVBE	662532 <b>63034</b>				
	2,070	1	3SGP60-GVSP	662532 <b>15030</b>						
	2,070	1	5SG46-GVSP	662532 <b>03453</b>						
	2,070	1	5SG46-IVS	662532 <b>02842</b>						
	2,070	1	5SG46-IVS3	662434 <b>95319</b>						
	2,070	1	5SG46-JVS	662532 <b>02926</b>						
2,070	1	5SG60-GVSP	662532 <b>62596</b>							
12 x 2 x 1-1/4	2,070	1			32A46-KVBE	662532 <b>63461</b>				
	2,070	1			32A46-MVBE	662532 <b>63463</b>				
12 x 2 x 3	2,070	1			32A46-IVBE	662532 <b>63459</b>				
12 x 2 x 5	2,070	1			32A46-HVBE	662532 <b>63403</b>				
	2,070	1			32A46-IVBE	662532 <b>62302</b>				
	2,070	1			32A60-KVBE	662532 <b>63465</b>				
14 x 1/2 x 5	1,800	1	5SG80-KVS	662533 <b>63814</b>	32A60-KVBE	662533 <b>63761</b>				
14 x 3/4 x 5	1,800	1			32A60-KVBE	662533 <b>63772</b>				
14 x 1 x 3	1,800	1	5SG46-IVS	662533 <b>63960</b>	32A46-HVBE	662533 <b>63912</b>				
	1,800	1			32A46-IVBE	662533 <b>63914</b>				
	1,800	1			32A60-IVBE	662533 <b>63927</b>				

\* 12" Type O1 Wheel Maximum RPM: NORPOR VP2 Wheels = 2,710; all others = 2,070

B Best Seller; performs well in a variety of applications for many satisfied customers

To maximize the performance of these wheels and finished part quality, refer to the beginning of this section and the "Dressing Solutions" section for truing and dressing products.

For non-stock toolroom wheels: if you don't see the toolroom wheel you need in our stock listing, call your local authorized Norton distributor to check our made-to-order non-stock availability – including our revolutionary new Quantum ceramic and Vitrium<sup>3</sup> bond wheels.

Vitrified Wheels For Steel Applications *continued*



TIER: <b>BEST</b>	TIER: <b>BETTER</b>	TIER: <b>GOOD</b>
TRADENAME: <b>QUANTUM / NORTON SG</b>	TRADENAME: <b>32A</b>	TRADENAME: <b>38A / 57A</b>
ABRASIVE: Ceramic Alumina	ABRASIVE: Aluminum Oxide	ABRASIVE: Aluminum Oxide

SIZE (D x T x H)	MAX. RPM	MIN./STD. PKG.	SPEC.	PART #	SPEC.	PART #	MIN./STD. PKG.	SPEC.	PART #
<b>Type O1 Straight</b> 									
14 x 1/2 x 5	1,800	1	5SG80-KVS	662533 <b>63814</b>	32A60-KVBE	662533 <b>63761</b>			
14 x 3/4 x 5	1,800	1			32A60-KVBE	662533 <b>63772</b>			
14 x 1 x 3	1,800	1	5SG46-IVS	662533 <b>63960</b>	32A46-HVBE	662533 <b>63912</b>			
	1,800	1			32A46-IVBE	662533 <b>63914</b>			
	1,800	1			32A60-IVBE	662533 <b>63927</b>			
14 x 1 x 5	1,800	1	5SG46-GVSP	662533 <b>64108</b>	32A46-GVBEP	662533 <b>64074</b>	1	38A46-HVBE	662533 <b>64043</b>
	1,800	1	5SG46-HVSP	662533 <b>13990</b>	32A46-HVBE	662533 <b>63913</b>	1	38A60-IVBE	662533 <b>63947</b>
	1,800	1	5SG46-IVS	662533 <b>63970</b>	32A46-IVBE	662533 <b>63915</b>	1	38A60-JVBE	662533 <b>64051</b>
	1,800	1	5SG46-JVS	662533 <b>63971</b>	32A46-JVBE	662533 <b>63919</b>	1	38A60-KVBE	662533 <b>64053</b>
	1,800	1			32A46-KVBE	662533 <b>63921</b>	1	38A80-KVBE	662533 <b>64058</b>
	1,800	1	5SG60-IVS	662533 <b>63974</b>	32A60-GVBEP	662533 <b>64077</b>	1	57A60-KVBE	662533 <b>64065</b>
	1,800	1	5SG60-IVSP	662533 <b>63871</b>	32A60-HVBE	662533 <b>63926</b>	1	57A60-LVBE	662533 <b>64066</b>
	1,800	1	5SG60-JVS	662533 <b>63975</b>	32A60-JVBE	662533 <b>63930</b>	1	57A80-MVBE	662533 <b>64070</b>
	1,800	1	5SG60-KVS	662533 <b>63976</b>	32A60-KVBE	662533 <b>63932</b>			
	1,800	1	5SG80-JVS	662533 <b>63979</b>	32A60-LVBE	662533 <b>64035</b>			
	1,800	1	5SG80-KVS	662533 <b>64003</b>	32A80-JVBE	662533 <b>64038</b>			
	1,800	1			32A80-KVBE	662533 <b>64039</b>			
14 x 1 x 8	1,800	1			32A60-IVBE	662533 <b>63887</b>			
14 x 1-1/2 x 5	1,800	1	5NQ46-HVS3	662533 <b>87216</b>	32A46-GVBEP	662533 <b>64238</b>	1	38A46-HVBE	662533 <b>13968</b>
	1,800	1	5NQ46-IVS3	662533 <b>87219</b>	32A46-HVBE	662533 <b>64335</b>	B 1	38A46-HVBEP	662533 <b>13969</b>
	1,800	1	5NQ46-IVS	690831 <b>59119</b>	32A46-HVBEP	662533 <b>64243</b>	1	38A46-IVBE	662533 <b>64090</b>
	1,800	1	5NQ46-JVS	690831 <b>59120</b>	32A46-JVBE	662533 <b>64336</b>	1	38A46-JVBE	662533 <b>64240</b>
	1,800	1	5NQ46-JVS3	662434 <b>94095</b>	32A46-JVBE	662533 <b>64337</b>	1	38A60-IVBE	662533 <b>64247</b>
	1,800	1	5NQ60-GVS3P	662434 <b>95372</b>	32A46-KVBE	662533 <b>64339</b>			
	1,800	1	5NQ60-GVSP	690831 <b>59122</b>	32A60-HVBE	662533 <b>64340</b>			
	1,800	1	5NQ60-JVS	690831 <b>59124</b>	32A60-IVBE	662533 <b>64239</b>			
	1,800	1	5NQ60-JVS3	662434 <b>94096</b>	32A60-JVBE	662533 <b>64341</b>			
	1,800	1	3SGP46-GVSP	662533 <b>06780</b>	32A60-KVBE	662533 <b>64342</b>			
	1,800	1	3SGP46-HVSP	662533 <b>07025</b>	32A80-JVBE	662533 <b>64246</b>			
	1,800	1	3SGP46-JVH	662533 <b>13976</b>					
	1,800	1	5SG46-GVSP	662533 <b>64320</b>					
	1,800	1	5SG46-HVS3	662533 <b>87231</b>					
	1,800	1	5SG46-HVSP	662533 <b>02625</b>					
	1,800	1	5SG46-IVS	662533 <b>64097</b>					
	1,800	1	5SG46-IVS3	662533 <b>87234</b>					
	1,800	1	5SG46-IVSP	662533 <b>02498</b>					
	1,800	1	5SG46-JVS	662533 <b>64098</b>					
	1,800	1	5SG60-IVS	662533 <b>64100</b>					
	1,800	1	5SG60-JVS	662533 <b>64101</b>					
	1,800	1	5SG60-KVS	662533 <b>02160</b>					
	1,800	1	5SG80-KVS	662533 <b>63815</b>					
14 x 2 x 5	1,800	1	5SG60-JVS	662533 <b>64414</b>	32A46-IVBE	662533 <b>64323</b>			
	1,800	1			32A46-JVBE	662533 <b>64508</b>			
	1,800	1			32A46-KVBE	662533 <b>64509</b>			
	1,800	1			32A60-KVBE	662533 <b>64510</b>			

B Best Seller; performs well in a variety of applications for many satisfied customers

Dressing: Single Point Dressing Tool Starting Recommendations

WHEEL SIZES	TOOL SHANK DIAMETER	Ceramic (NQ, Norton SG, TG, etc.), 37C & 39C Wheels		25A, 32A, 38A, 48A, 53A, 57A, 64A, 86A Wheels	
		PRODUCT NO.	PART #	PRODUCT NO.	PART #
12" to 14"	3/8"	BCSG5M6	662601 <b>57009</b>	BC5M6	662601 <b>95004</b>
	7/16"	BCSG5M7	662601 <b>56907</b>	BC5M7	662601 <b>95005</b>

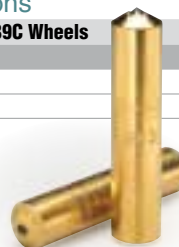

These tools are a standard recommendation; see the "Dressing Solutions" section for additional tools. See the Fliesen Tool section for Furioso tools, engineered specifically for Quantum vitrified wheel dressing.



Vitrified Wheels For Steel Applications *continued*



TIER:	BEST	BETTER	GOOD
TRADENAME:	<b>QUANTUM / NORTON SG</b>	<b>32A / 23A / 48A</b>	<b>38A / 53A / 57A</b>
ABRASIVE:	Ceramic Alumina	Aluminum Oxide	Aluminum Oxide

SIZE (D x T x H)	MAX. RPM	MIN./STD. PKG.	SPEC.	PART #	SPEC.	PART #	MIN./STD. PKG.	SPEC.	PART #
<b>Type O2 Cylinder</b> 									
6 x 1 x 4	3,600	1/10			32A46-KVBE	662528 <b>38308</b>	1/10	38A80-HVBE	662528 <b>38314</b>
Rim 1"	3,600	1/10			32A60-JVBE	662528 <b>38309</b>			
Plate A47466									
8 x 2 x 5-1/2	2,865						1/8	53A46-KVBE	662530 <b>44942</b>
Rim 1-1/4"									
Plate A50831									
10 x 2 x 7-1/2	2,295	1			32A54-JVG	662531 <b>61687</b>	1	53A60-KVG	662531 <b>61701</b>
Rim 1-1/4"									
(ME62845)									
Plate A110170									
11 x 5	1,910	1			32A30-HVBE	662531 <b>61800</b>			
Rim 1" (ME33437)									
Tape Wound									
11 x 5	1,740	1			32A36-EVBEP	662531 <b>61780</b>	1	38A46-GVBE	662531 <b>61807</b>
Rim 1" (ME52726)	1,910	1			32A36-GVBEP	662531 <b>61808</b>			
Tape Wound	1,910	1			32A46-HVBE	662531 <b>61893</b>			
18 x 5 Rim 1-1/2"	1,065	1			32A30-E19VCP	662534 <b>65142</b>			
(ME15536)									
Tape Wound									
18 x 5 Rim 1-1/2"	1,170	1			23A30-F19VCP	662534 <b>65235</b>			
(ME52719)									
Tape Wound									
Includes Strips									
<b>Type O5 Recessed One Side</b> 									
3/4 x 3/4 x 1/4	43,290	5/40			32A60-KVBE	662434 <b>27582</b>			
Recess 1/S 3/8 x 3/8									
1 x 1 x 1/4	32,470	5/40			32A60-KVBE	662434 <b>27769</b>			
Recess 1/S 1/2 x 1/2									
1 x 1 x 3/8	32,470	5/40			32A60-KVBE	662434 <b>27773</b>			
Recess 1/S 1/2 x 1/2									
1-1/4 x 1 x 3/8	25,975	5/40			32A60-KVBE	662434 <b>27799</b>			
Recess 1/S 5/8 x 1/2									
1-1/2 x 1 x 3/8	25,975	5/40			32A60-KVBE	662434 <b>27938</b>			
Recess 1/S 5/8 x 1/2									
1-1/2 x 1 x 3/8	21,645	5/40			32A60-KVBE	662434 <b>27937</b>			
Recess 1/S 3/4 x 1/2									
2 x 1 x 3/8	16,235	5/40			32A60-KVBE	662434 <b>28329</b>			
Recess 1/S 3/4 x 1/2									
2 x 1-1/2 x 5/8	16,235	10/30			32A60-KVBE	662434 <b>28332</b>			
Recess 1/S 1 x 3/4									
7 x 3/4 x 1-1/4	3,600	1/10	5SG46-IVS	662529 <b>41976</b>	32A46-HVBE	662529 <b>42209</b>	1/10	38A46-IVBE	662529 <b>42222</b>
Rec 1/S 2-3/4 x 1/4	3,600	1/10			32A46-IVBE	662529 <b>42211</b>	1/10	38A60-IVBE	662529 <b>42225</b>
	3,600	1/10			32A46-JVBE	662529 <b>42213</b>			
	3,600	1/10			32A60-IVBE	662529 <b>42217</b>			
	3,600	1/10			32A60-JVBE	662529 <b>42218</b>			
	3,600	1/10			32A60-KVBE	662529 <b>42205</b>			
	3,600	1/10			32A46-GVBEP	662529 <b>42826</b>			
7 x 1 x 1-1/4	3,600	1/10			32A46-HVBE	662529 <b>42688</b>			
Rec 1/S 2-3/4 x 1/2	3,600	1/10	3SGR46-HVP2	662529 <b>16228</b>	32A46-HVBE	662529 <b>42688</b>			
	3,600	1/10	5SG46-IVS	662529 <b>42318</b>	32A46-HVBEP	662529 <b>42828</b>			
	3,600	1/10			32A46-IVBE	662529 <b>42691</b>			
	3,600	1/10	5SG46-JVS	662529 <b>42427</b>	32A46-KVBE	662529 <b>42708</b>			
	3,600	1/10			32A60-IVBE	662529 <b>42699</b>			
	3,600	1/10	5SG60-JVS	662529 <b>42431</b>	32A60-JVBE	662529 <b>42701</b>			
	3,600	1/10			32A60-KVBE	662529 <b>42703</b>			
	3,600	1/10			48A46-HVP2	662529 <b>16232</b>			

Continued

For non-stock toolroom wheels: if you don't see the toolroom wheel you need in our stock listing, call your local authorized Norton distributor to check our made-to-order non-stock availability – including our revolutionary new Quantum ceramic and Vitrium<sup>3</sup> bond wheels.

Vitrified Wheels For Steel Applications *continued*



TIER: **BEST** **BETTER** **GOOD**  
 TRADENAME: **QUANTUM / NORTON SG** **32A / 48A** **38A / GEMINI**  
 ABRASIVE: Ceramic Alumina Aluminum Oxide Aluminum Oxide

SIZE (D x T x H)	MAX. RPM	MIN./STD. PKG.	SPEC.	PART #	SPEC.	PART #	MIN./STD. PKG.	SPEC.	PART #
<b>Type 05 Recessed One Side</b>									
7 x 1 x 1-1/4	3,600	1/10	5NQ46-IVS	662533 <b>50691</b>	32A46-HVBE	662529 <b>42689</b>	1/10	38A46-HVBE	662529 <b>42707</b>
Rec 1/S 3 x 1/2	3,600	1/10	5SG46-IVS	662529 <b>01814</b>	32A46-IVBE	662529 <b>42690</b>	1/10	38A46-IVBE	662529 <b>42809</b>
	3,600	1/10			32A60-IVBE	662529 <b>42686</b>	1/10	38A46-KVBE	662529 <b>42793</b>
	3,600	1/10	5SG60-IVS	662529 <b>06907</b>			1/10	38A60-IVBE	662529 <b>42815</b>
	3,600	1/10	5SG60-IVS3	662434 <b>94102</b>			1/10	38A60-JVBE	662529 <b>42816</b>
	3,600						1/10	38A60-KVBE	662529 <b>42817</b>
	3,600					10/10	Gemini 46-J	662532 <b>46835</b>	
7 x 1-1/4 x 1-1/4	3,600	1/5			32A46-HVBE	662529 <b>42833</b>			
Rec 1/S 2-3/4 x 5/8	3,600	1/5			32A60-IVBE	662529 <b>42859</b>			
	3,600	1/5			32A60-JVBE	662529 <b>42835</b>			
7 x 1-1/2 x 1-1/4	3,600	1/5			32A46-IVBE	662529 <b>42843</b>			
Rec 1/S 2-3/4 x 3/4	3,600	1/5			32A60-IVBE	662529 <b>42844</b>			
8 x 3/4 x 1-1/4	3,105	1/10			32A46-IVBE	662530 <b>44213</b>			
Rec 1/S 3-1/4 x 1/4									
8 x 1 x 1-1/4	3,600						10/10	Gemini 46-J	662532 <b>46850</b>
Rec 1/S 3 x 1/2									
8 x 1 x 1-1/4	3,105	1/10	5SG46-IVS	662530 <b>13543</b>	32A46-IVBE	662530 <b>44790</b>			
Rec 1/S 3-1/4 x 1/2	3,600	1/10			32A46-JVBE	662530 <b>44382</b>			
	3,600	1/10	5SG46-JVS	662530 <b>03301</b>	32A46-JVS3	662434 <b>95329</b>			
	3,600	1/10			32A60-IVBE	662530 <b>44753</b>			
	3,600	1/10			32A60-KVBE	662530 <b>44810</b>			
10 x 3/4 x 2	2,485	1			32A60-JVBE	662531 <b>60189</b>			
Rec Side A									
5 x 3/16 Face Bev									
Side A 75 Deg									
From 1/8" Flat									
12 x 1-1/2 x 3	2,070	1			32A46-IVBE	662532 <b>63186</b>			
Rec 1/S 6 x 1/2									
12 x 1-1/2 x 5	2,070 / 2,710*	1	3SGR46-HVP2	662532 <b>20904*</b>	32A46-HVBEP	662532 <b>63180</b>	1	38A46-IVBE	662532 <b>63175</b>
Rec 1/S 7-1/2 x 1/2	2,070	1	5SG46-GVSP	662532 <b>63127</b>	32A46-IVBE	662532 <b>63166</b>			
	2,070	1			32A46-JVBE	662532 <b>63169</b>			
	2,070	1	5SG46-IVS	662532 <b>02883</b>	32A46-KVBE	662532 <b>63170</b>			
	2,070	1			32A60-KVBE	662532 <b>63172</b>			
				5SG60-IVSP	662532 <b>63050</b>				
14 x 1-1/2 x 5	1,800 / 2,320*	1	3SGR46-GVP2	662533 <b>19953*</b>	32A46-HVBE	662533 <b>64359</b>			
Rec 1/S 8 x 1/2	1,800 / 2,320*	1	3SGR46-HVP2	662533 <b>19954*</b>	32A46-IVBE	662533 <b>64300</b>			
	1,800 / 2,320*	1	3SGR60-HVP2	662533 <b>19956*</b>	32A46-KVBE	662533 <b>64362</b>			
	1,800	1	5SG46-IVS	662533 <b>64102</b>	32A60-JVBE	662533 <b>64364</b>			
	1,800	1	5SG46-IVS3	662434 <b>94106</b>	32A60-KVBE	662533 <b>64365</b>			
	1,800	1	5SG46-JVS	662533 <b>64103</b>					
	1,800	1	5SG60-IVS	662533 <b>64104</b>					
	1,800	1	5SG60-JVS	662533 <b>64105</b>					
14 x 2 x 5	2,320	1	3SGR46-GVP2	662533 <b>19936</b>	48A46-HVP2	662533 <b>19941</b>	1	25A46-HVP2	662533 <b>19945</b>
Rec 1/S 8 x 1/2	2,320	1	3SGR46-HVP2	662533 <b>19937</b>			1	38A46-HVP2	662533 <b>19949</b>
	2,320						1	38A60-HVP2	662533 <b>19951</b>
14 x 2 x 5	1,800	1			32A60-KVBE	662533 <b>64390</b>			
Rec 1/S 8 x 1									

\* 12" Type 05 Wheel Maximum RPM: NORPOR VP2 Wheels = 2,710; all others = 2,070

\* 14" Type 05 Wheel Maximum RPM: NORPOR VP2 Wheels = 2,320; all others = 1,800

To maximize the performance of these wheels and finished part quality, refer to the beginning of this section and the "Dressing Solutions" section for truing and dressing products.

For non-stock toolroom wheels: if you don't see the toolroom wheel you need in our stock listing, call your local authorized Norton distributor to check our made-to-order non-stock availability – including our revolutionary new Quantum ceramic and Vitrium<sup>3</sup> bond wheels.

## Vitrified Wheels For Steel Applications *continued*



TIER: <b>BEST</b>	TIER: <b>BETTER</b>	TIER: <b>GOOD</b>
TRADENAME: <b>NORTON SG</b>	TRADENAME: <b>32A / 48A</b>	TRADENAME: <b>38A / 25A / 53A</b>
ABRASIVE: Ceramic Alumina	ABRASIVE: Aluminum Oxide	ABRASIVE: Aluminum Oxide

SIZE (D x T x H)	MAX. RPM	MIN./STD. PKG.	SPEC.	PART #	SPEC.	PART #	MIN./STD. PKG.	SPEC.	PART #
<b>Type 06 Straight Cup</b>									
3-1/2 x 1-1/2 x 1/2 Rim 1/2" Back 1/2"	6,550						1/10	38A60-KVBE	662435 <b>29372</b>
100mm x 50mm x 20mm Rim 10mm, Back 13mm	6,550						1/10	38A80-JVBE	662435 <b>30429</b>
4 x 1-1/2 x 1/2 Rim 1/2" Back 1/2"	5,730	1/10			32A60-KVBE	662435 <b>30218</b>			
4 x 1-1/2 x 1-1/4 Rim 1/2" Back 1/2"	5,730						1/10	38A60-KVBE	662435 <b>30221</b>
4 x 2 x 20mm Rim 3/8" Back 1/2"	5,730						1/10	38A80-JVBE	662435 <b>30523</b>
5 x 1-1/2 x 1-1/4 Rim 3/8" Back 3/8"	4,585	1/10			32A46-KVBE	662528 <b>30832</b>	1/10	38A46-KVBE	662528 <b>30842</b>
Face Y (ME19243)	4,585	1/10			32A60-JVBE	662528 <b>30837</b>	1/10	38A60-KVBE	662528 <b>30846</b>
5 x 2 x 5/8 Rim 1/2" Back 1/2"	4,585	1/10			32A60-KVBE	662528 <b>30838</b>			
5 x 2 x 5/8 Rim 1/2" Back 1/2"	4,585	1/10			32A60-JVBE	662528 <b>30987</b>			
6 x 1-1/2 x 1/2 Rim 1" Back 1/2"	3,820	1/10			32A46-KVBE	662528 <b>38458</b>			
6 x 2 x 1-1/4 Rim 1/2" Back 1/2"	3,820	1/10			32A46-IVBE	662528 <b>38544</b>	1/10	38A60-KVBE	662528 <b>38486</b>
7 x 2 x 1-1/4 Rim 1/2" Back 1/2"	3,275	1/8			32A60-JVBE	662528 <b>38538</b>			
7 x 2 x 1-1/4 Rim 1/2" Back 1/2"	3,275	1/8			32A46-JVBE	662529 <b>42856</b>			
9-1/2 x 1-1/2 x 1-1/2 Rim 1-1/2" Back 5/8"	2,415						1	53A46-LVBE	662531 <b>49136</b>
10 x 4 x 1-1/2 Rim 1-1/4" Back 1"	2,295						1	38A46-IVBE	662531 <b>61797</b>
Tape Wound									
12 x 2-1/2 x 7 Rim 1-1/2" Back 7/8"	1,910	1			32A46-LVBE	662532 <b>63614</b>			
<b>Type 07 Recessed Two Sides</b>									
12 x 2 x 3 Rec 2/S 5-1/2 x 3/8	2,070	1			32A46-IVBE	662532 <b>63588</b>			
12 x 2 x 3 Rec 2/S 7-1/4 x 1/2	2,070	1			32A46-HVBE	662532 <b>63590</b>			
12 x 2 x 5 Rec 2/S 7-1/4 x 1/2	2,070	1			32A46-JVBE	662532 <b>63348</b>			
12 x 2 x 5 Rec 2/S 7-1/4 x 1/2	2,070	1			32A46-IVBE	662532 <b>63594</b>			
12 x 2 x 5 Rec 2/S 7-1/2 x 1/2	2,070	1	5SG46-JVS	662532 <b>09930</b>	32A46-HVBE	662532 <b>63591</b>	1	38A46-IVBE	662532 <b>63600</b>
	2,070	1			32A46-HVBEP	662532 <b>63603</b>			
	2,070	1			32A46-JVBE	662532 <b>63483</b>			
	2,070	1			32A46-KVBE	662532 <b>63596</b>			
	2,070	1			32A60-IVBE	662532 <b>63597</b>			







Vitrified Wheels For Steel Applications *continued*

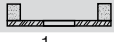

TIER: **BEST** **NORTON SG** **BETTER** **32A** **GOOD** **38A**  
 TRADENAME: **NORTON SG** **32A**  
 ABRASIVE: Ceramic Alumina Aluminum Oxide Aluminum Oxide

SIZE (D x T x H)	MAX. RPM	MIN./STD. PKG.	SPEC.	PART #	SPEC.	PART #	MIN./STD. PKG.	SPEC.	PART #
<b>Type 11 Flaring Cup</b> 									
3/2-1/4 x 1-1/4 x 3/4	7,640	1/10			32A60-JVBE	662435 <b>29183</b>	1/10	38A60-JVBE	662435 <b>29197</b>
Rim 1/4" Back 3/8"	7,640	1/10			32A60-KVBE	662435 <b>29187</b>			
Face Z (ME21560)									
3-1/2/2-3/4 x 1-1/2 x 1-1/4	7,640	1/10			32A60-KVBE	662435 <b>29358</b>			
Rim 1/4" Back 3/8"									
Face Z (ME24327)									
4/3 x 1-1/2 x 1-1/4	5,730	1/5	5SG46-IVSP	662435 <b>30127</b>	32A46-IVBE	662435 <b>30240</b>	1/10	38A46-KVBE	662435 <b>30378</b>
Rim 1/4" Back 1/2"	5,730	1/5	5SG46-KVS	662435 <b>03342</b>	32A46-KVBE	662435 <b>30246</b>	1/10	38A60-JVBE	662435 <b>30387</b>
Face Z (ME19237)	5,730	1/5			32A60-JVBE	662435 <b>30256</b>	1/10	38A60-KVBE	662435 <b>30390</b>
	5,730	1/5	5SG60-JVS	662435 <b>30415</b>	32A60-KVBE	662435 <b>30361</b>	1/10	38A80-JVBE	662435 <b>30393</b>
	5,730	1/5					1/10	38A80-KVBE	662435 <b>30395</b>
	5,730	1/5	5SG60-LVS	662435 <b>30417</b>	32A80-KVBE	662435 <b>30368</b>			
	5,730	1/5	5SG80-JVS	662435 <b>30419</b>					
	5,730	1/5	5SG80-KVS	662435 <b>30420</b>					
4-1/2/3-3/4 x 2 x 1-1/4	5,730	1/5			32A46-KVBE	662528 <b>30539</b>			
Rim 1/4"									
Back 1/2"(ME20115)									
5/3-3/4 x 1-3/4 x 1-1/4	4,585	1/5	5SG46-KVS	662528 <b>03291</b>	32A46-JVBE	662528 <b>30858</b>	1/5	38A46-KVBE	662528 <b>30971</b>
Rim 1/4" Back 1/2"	4,585	1/5	5SG60-KVS	662528 <b>30737</b>	32A46-KVBE	662528 <b>30859</b>	1/5	38A60-JVBE	662528 <b>30973</b>
Face Z (ME21563)	4,585	1/5					1/5	38A60-KVBE	662528 <b>30975</b>
	4,585	1/5	5SG60-LVS	662528 <b>30736</b>	32A60-JVBE	662528 <b>30962</b>			
	4,585	1/5			32A60-KVBE	662528 <b>30964</b>			
6/4-1/2 x 2 x 1-1/4	3,820	1/5			32A46-JVBE	662528 <b>38491</b>	1/5	38A46-KVBE	662528 <b>38495</b>
Rim 3/8" Back 1/2"	3,820	1/5			32A46-KVBE	662528 <b>38528</b>	1/5	38A60-KVBE	662528 <b>38497</b>
Face Z (ME19241)	3,820	1/5			32A60-JVBE	662528 <b>38492</b>			
7/5 x 2 x 1-1/4	3,275	1/8			32A46-JVBE	662529 <b>42959</b>	1/8	38A46-HVBE	662529 <b>42963</b>
Rim 3/4" Back 1/2"									
(ME19242)									
<b>Type 12 Dish</b> 									
4 x 1/2 x 3/4	6,207	1/10			32A60-KVBE	662435 <b>30067</b>			
(ME19226)									
6 x 1/2 x 1-1/4	4,140	1/10	5SG60-LVS	662528 <b>36574</b>	32A46-JVBE	662528 <b>36860</b>	1/10	38A60-JVBE	662528 <b>36977</b>
(ME19229)	4,140	1/10			32A60-JVBE	662528 <b>36966</b>			
6 x 3/4 x 1-1/4	4,140	1/10	5SG60-KVS	662528 <b>37771</b>	32A46-KVBE	662528 <b>37732</b>			
(ME19230)	4,140	1/10			32A60-JVBE	662528 <b>37734</b>			
	4,140	1/10			32A60-KVBE	662528 <b>37735</b>			
	4,140	1/10			32A60-KVBE	662528 <b>37735</b>			
7 x 1/2 x 1-1/4	3,600	1/10			32A46-KVBE	662529 <b>41644</b>			
(ME13717)	3,600	1/10			32A60-KVBE	662529 <b>41647</b>			
8 x 3/4 x 1-1/4	3,600						1/10	38A60-KVBE	662530 <b>44319</b>
(ME19231)									
10 x 1 x 1	2,485	1			32A54-JVBE	662531 <b>61196</b>			
(ME38702)									
10 x 1 x 1-1/4	2,485	1			32A54-JVBE	662531 <b>61197</b>			
(ME38702)									
<b>Type 20 Concave One Side</b> 									
14 x 1-1/2 x 5	1,800	1	5SG60-JVS	662533 <b>02265</b>	32A60-JVBE	662533 <b>64250</b>			
Concave from Periphery	1,800	1			32A60-KVBE	662533 <b>64332</b>			
1/2" Deep to 8" Flat Spot									
<b>Type 35 Plate Mounted Disc</b> 									
9 x 2 x 4-15/16	2,550	1			32A46-MVBE	662530 <b>49115</b>			
Rim 2-1/32" (ME31130)	2,550	1			32A60-J25VCF2	662530 <b>06557</b>			
Plate A47248	2,550	1			32A70-JVBEP	662530 <b>49112</b>			

For non-stock toolroom wheels: if you don't see the toolroom wheel you need in our stock listing, call your local authorized Norton distributor to check our made-to-order non-stock availability – including our revolutionary new Quantum ceramic and Vitrium<sup>3</sup> bond wheels.



These sharp silicon carbide, vitrified wheels are used for grinding non-ferrous applications.

**Applications:**

Use 39C (green silicon carbide) for cemented carbides, titanium, metal matrix composites and plasma sprayed materials.  
Use 37C (black silicon carbide) on 300 series stainless steels, irons, nonferrous metals (aluminum, brass, bronze and copper) and non-metallic materials (stone, marble, rubber, ceramics and glass).

**Shapes:**

Type 01 Straight, Type 02 Cylinder, and Type 05 Recessed 1 Side

**Size Range:**

3" – 14" diameter

**Grit Range:**

24 – 120

**Abrasive Grain:**



39C Green Silicon Carbide, 37C Black Silicon Carbide

Vitrified Wheels For Non-Ferrous Applications

TIER: **GOOD**  
TRADENAME: **39C / 37C**  
ABRASIVE: Silicon Carbide

SIZE (D x T x H)	MAX. RPM	MIN./STD. PKG.	SPEC.	PART #	
<b>Type 01 Straight</b> 					
3 x 1/2 x 1/2	10,825	10/50	37C60-MVK	662435 <b>29041</b>	
3 x 1 x 1/2	10,825	10/10	37C60-MVK	662435 <b>29166</b>	
	10,825	10/10	37C80-HVK	662435 <b>29170</b>	
	10,825	10/10	37C80-MVK	662435 <b>29171</b>	
	10,825	10/10	37C100-HVK	662435 <b>29172</b>	
	10,825	10/10	37C100-MVK	662435 <b>29070</b>	
3-1/2 x 1-1/2 x 7/8 (ME622)	7,095	1/10	37C24-SVK	662435 <b>29339</b>	
	7,095	1/10	37C30-SVK	662435 <b>29338</b>	
4 x 1/2 x 1/2	8,120	1/10	37C60-MVK	662435 <b>29960</b>	
	8,120	1/10	39C100-IVK	662435 <b>30064</b>	
6 x 1/2 x 1-1/4	4,140	1/10	39C60-IVK	662528 <b>36706</b>	
	4,140	1/10	39C80-IVK	662528 <b>36816</b>	
	4,140	1/10	39C100-IVK	662528 <b>36827</b>	
	4,140	1/10	39C120-IVK	662528 <b>36836</b>	
6 x 3/4 x 1-1/4	4,140	1/10	39C60-IVK	662528 <b>37584</b>	
	4,140	1/10	39C80-IVK	662528 <b>37598</b>	
	4,140	1/10	39C100-IVK	662528 <b>37717</b>	
	4,140	1/10	39C60-IVK	662528 <b>38161</b>	
6 x 1 x 1-1/4	4,140	1/10	39C80-IVK	662528 <b>38173</b>	
	3,600	1/10	39C80-JVK	662529 <b>40007</b>	
7 x 1/4 x 1-1/4	3,600	1/10	39C100-IVK	662529 <b>40109</b>	
	3,600	1/10	39C120-IVK	662529 <b>40111</b>	
	3,600	1/10	37C46-JVK	662529 <b>41488</b>	
	3,600	1/10	37C60-OVK	662529 <b>41498</b>	
7 x 1/2 x 1-1/4	3,600	1/10	39C60-IVK	662529 <b>41609</b>	
	3,600	1/10	39C60-JVK	662529 <b>41611</b>	
	3,600	1/10	39C60-KVK	662529 <b>41613</b>	
	3,600	1/10	39C80-IVK	662529 <b>41617</b>	
	3,600	1/10	39C80-JVK	662529 <b>41618</b>	
	3,600	1/10	39C100-HVK	662529 <b>41622</b>	
	3,600	1/10	39C100-IVK	662529 <b>41624</b>	
	3,600	1/10	39C120-IVK	662529 <b>41632 B</b>	
	7 x 3/4 x 1-1/4	3,600	1/10	39C80-JVK	662529 <b>42096</b>
		3,600	1/10	39C100-JVK	662529 <b>42104</b>
7 x 1 x 1-1/4	3,600	1/10	39C60-IVK	662529 <b>42666</b>	
	3,600	1/10	39C80-IVK	662529 <b>42413</b>	
	3,600	1/10	39C120-IVK	662529 <b>42416</b>	
8 x 1/4 x 1-1/4	3,600	1/10	39C80-IVK	662530 <b>14526</b>	
8 x 3/8 x 1-1/4	3,600	1/10	39C80-IVK	699366 <b>64144</b>	
8 x 1/2 x 1-1/4	3,600	1/10	39C60-IVK	662530 <b>44013</b>	
	3,600	1/10	39C80-IVK	662530 <b>44015</b>	
	3,600	1/10	39C100-IVK	662530 <b>44017 B</b>	

TIER: **GOOD**  
TRADENAME: **39C / 37C**  
ABRASIVE: Silicon Carbide

SIZE (D x T x H)	MAX. RPM	MIN./STD. PKG.	SPEC.	PART #
<b>Type 01 Straight</b> 				
8 x 3/4 x 1-1/4	3,600	1/10	39C60-JVK	662530 <b>44312</b>
	3,600	1/10	39C80-IVK	662533 <b>50645</b>
	3,600	1/10	39C100-IVK	662530 <b>44314</b>
8 x 1 x 1-1/4	3,600	1/10	39C60-JVK	662530 <b>44770</b>
	3,600	1/10	39C80-IVK	662530 <b>44425 B</b>
	3,600	1/10	39C100-IVK	662530 <b>44379</b>
	2,485	1	39C60-JVK	662531 <b>160348</b>
	2,485	1	39C60-JVK	662531 <b>161640</b>
10 x 1 x 3	2,485	1	39C60-IVK	662532 <b>62985</b>
12 x 1 x 3	2,070	1	39C60-IVK	662532 <b>62884</b>
	2,070	1	39C80-JVK	662532 <b>62988</b>
14 x 1 x 5	1,800	1	39C60-JVK	662533 <b>64206</b>
	1,800	1	39C80-JVK	662533 <b>64208</b>
	1,800	1	39C60-JVK	662533 <b>64242</b>
14 x 1-1/2 x 5	1,800	1	39C60-JVK	662533 <b>64242</b>
14 x 2 x 5	1,800	1	39C60-JVK	662533 <b>64322</b>
<b>Type 02 Cylinder</b> 				
6 x 1 x 4	3,600	1/10	39C60-IVK	662528 <b>38322</b>
Rim 1"	3,600	1/10	39C60-JVK	662528 <b>38324</b>
Plate A47466	3,600	1/10	39C80-IVK	662528 <b>38327</b>
	3,600	1/10	39C100-IVK	662528 <b>38330</b>
	3,600	1/10	39C120-IVK	662528 <b>38193</b>
6 x 1-1/4 x 4	3,600	1/10	39C60-IVK	662528 <b>38345</b>
Rim 1"				
Plate A47466				
10 x 2 x 7	2,100	1	39C60-HVK	662531 <b>161675</b>
Rim 1-1/2"	2,295	1	39C60-JVK	662531 <b>161678</b>
Plate A83831				
<b>Type 05 Recessed One Side</b> 				
14 x 1-1/2 x 5	1,800	1	39C60-IVK	66253364328
Rec 1/5 8 x 1/2				

B = Best Seller, performs well in a variety of applications for many satisfied customers





Large surface grinding wheels are generally used to grind flat stock or flat surfaces within a workpiece. These wheels are typically used on horizontal spindle machines. Applications can vary from heavy, rapid stock removal to precision tolerance operations.

- Applications:**
- Producing flat stock
  - Grinding large molds and dies
  - Sharpening knives, blades and cutlery
  - Manufacturing broaches
- Shape:** Type 01 Straight, Type 07 Recessed 2 Sides
- Size Range:** Stock: 20" diameter  
1" – 6" thickness
- Abrasive Grain:** Aluminum Oxide

### Cross Reference Guide

NORTON	GOOD GEMINI
Camel	91A
Cincinnati Milacron	29A, 97A
Radiac	WAA, 97A, 45A



Good choice when a broad range of parts are ground on a few machines

## GEMINI ALUMINUM OXIDE BLEND

- Specially blended aluminum oxide abrasive for many surface grinding applications
- Porous bond is cool cutting on medium to wide contact areas; high chip clearance and stock removal
- Faster grinding rates remove stock, lower rates produce finer finishes; ideal when a broad range of tool steel parts are ground on a few machines

TIER: **GOOD**  
TRADENAME: **GEMINI**  
ABRASIVE: Aluminum Oxide

SIZE (D x T x H)	RECESS	MAX. RPM	STD. PKG.	SPEC.	PART #
<b>Type 01 Straight Wheels</b>					
20 x 1 x 8	–	1,625	1	Norton Gemini A46-H	662532 <b>46937</b>
20 x 2 x 10	–	1,625	1	Norton Gemini A36-J	662532 <b>46956</b>
<b>Type 07 Recessed Two Sides</b>					
20 x 2 x 8	Recess 2 Sides 11-1/2 x 1/2	1,625	1	Norton Gemini 59A46-I	662532 <b>46949</b>
	Recess 2 Sides 11-1/2 x 1/2	1,625	1	Norton Gemini A46-G VSP	662532 <b>46953</b>
20 x 3 x 8	Recess 2 Sides 11-1/2 x 1/2	1,625	1	Norton Gemini A46-G VSP	662532 <b>46972</b>
	Recessed 2 Sides 11-1/2 x 1/2	1,625	1	Norton Gemini A46-H	662532 <b>46969</b>
	Recess 2 Sides 11-1/2 x 1/2	1,625	1	Norton Gemini A46-I	662532 <b>46960</b>
20 x 3 x 10	Recess 2 Sides 12-1/4 x 3/4	1,625	1	Norton Gemini 59A46-I VSP	662530 <b>58315</b>
	Recess Side A 12-1/2 x 1/2, Side B 12-1/2 x 1	1,625	1	Norton Gemini A36-J VSP	662532 <b>46980</b>
	Recess Side A 12-1/2 x 1/2, Side B 12-1/2 x 1	1,625	1	Norton Gemini A46-D VSP	662532 <b>46988</b>

There are many more sizes and specifications available made-to-your-order. Contact your Norton representative with your custom requirements.

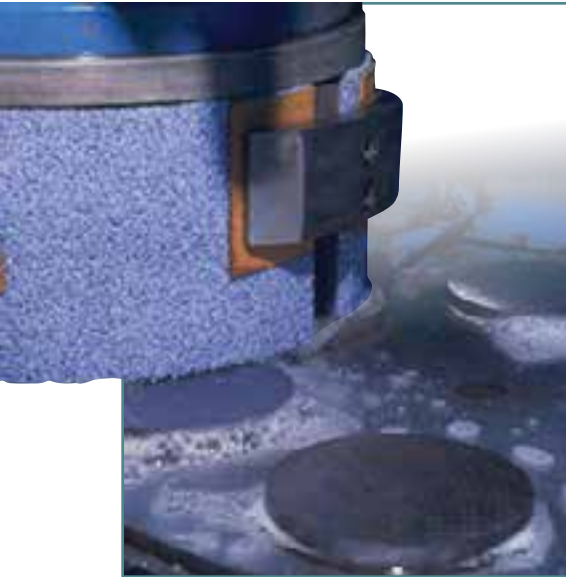

Surface grinding segments are generally used to grind flat stock or flat surfaces within a workpiece. The segment moves over the workpiece in a flat plane or vice versa. Applications can vary from heavy, rapid stock removal to precision tolerance operations.

- Applications:**
- Vertical spindle surface grinding
  - Grinding large molds, dies and plates
  - Producing flat stock
  - Sharpening knives, blades, cutlery
- Abrasive Grain:** Ceramic Alumina, Aluminum Oxide

### Material-to-Product Recommendation Guide

MATERIAL	HEAVY-DUTY				GENERAL-DUTY		
	QuantumX 20-G	QuantumX 30-F	86A24-G20VTX2	86A30-E20VTX2	Gemini 30-E	Gemini 30-F	Gemini 30-G
Aluminum				◆	◆		
Bronze (hard)							◆
Cast Iron	◆						◆
Hastalloy			◆		◆		
Inconel		◆			◆		
Hardened Steel	◆				◆		
High Speed Steel	◆				◆		
Soft Steel			◆	◆			◆
Stainless Steel 300				◆	◆		
Stainless Steel 400						◆	

### Segment Blueprints

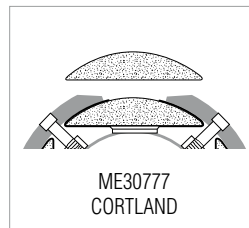
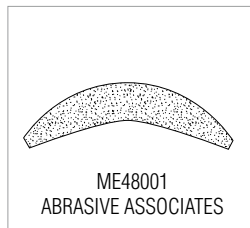
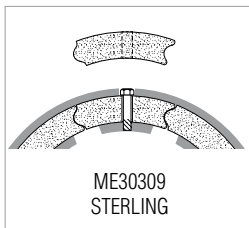
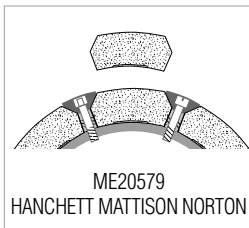

### Troubleshooting Guide

PROBLEM	CORRECTION
Segment acting too hard	Increase rate of downfeed Increase table rotation speed (watch amp-meter) Dress more frequently Consider reducing area of table load
Segment acting too soft	Decrease rate of downfeed Decrease table rotation speed Check for abnormal machine vibration
Glazing and/or burning	Choose a softer grade Increase table speed (watch amp-meter)

### TECH TIP

- Choose as coarse a grit size as possible in order to remove stock as quickly as possible (in big chips).
- To maximize production, choose the hardest grade possible that will not overload the machine.



It is the user's responsibility to refer to and comply with ANSI B7.1

Best choice for all low-, medium-, and high-force applications ranging from cast iron, to stainless steel and hard-to-grind alloys

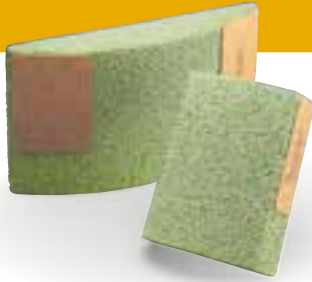

### QUANTUM AND QUANTUM X CERAMIC ALUMINA

- Revolutionary, versatile engineered ceramic grain shape and chemistry produce highest productivity with the lowest total grinding costs
- 33% to 100% longer life versus competitive ceramic products, 30% plus higher metal removal rate, with 15% plus lower threshold power
- Excellent performance on both old and new machines

Better choice for versatile, consistent performance



### 86A ALUMINUM OXIDE

- Sharper aluminum oxide abrasive grain delivers cooler-cutting, consistent performance
- Segments available for Hanchett, Mattison Norton, Sterling, Abrasive Associates, Cortland, and Cortland Bonus Grind machines
- Better choice with porous vitrified bond for increased chip clearance and cool cutting in heat-sensitive applications

Good choice when a broad variety of parts are ground on a few machines



### GEMINI ALUMINUM OXIDE BLEND

- Specially blended aluminum oxide abrasive for many surface grinding applications
- The porous vitrified bond increases chip clearance and maximizes coolant flow, reduces loading, and is cool cutting in heat-sensitive applications
- For use in Hanchett, Mattison, and Norton, and Cortland and Cortland Bonus Grind chucks on surface grinding machines



		TIER: <b>BEST</b>		TIER: <b>BETTER</b>		TIER: <b>GOOD</b>				
		TRADENAME: <b>QUANTUM/QUANTUM X</b>		TRADENAME: <b>86A</b>		TRADENAME: <b>GEMINI</b>				
		ABRASIVE: Ceramic Alumina		ABRASIVE: Aluminum Oxide		ABRASIVE: Aluminum Oxide Blend				
WIDTH	THICK	HEIGHT	BLUEPRINT NO.	STD. PKG.	SPEC.	UPC NO.	SPEC.	UPC NO.		
5	1-1/2	6	ME20579	8	QUANTUMX 20-G	662533 <b>50603</b>				
				8			86A24-H20VTX2	662533 <b>50602</b>	Gemini 30-E	662530 <b>50295</b>
				8			86A30-F12VBEP	614636 <b>50273</b>	Gemini 30-F	662530 <b>50297</b>
				8			86A24-G20VTX2	662533 <b>50595</b>	Gemini 30-G	662530 <b>50299</b>
6-13/16	1-1/2	6	ME30309	8						
				8			86A24-G20VTX2	662533 <b>50595</b>		
11	2-1/8	6	ME48001	5			86A24-G20VTX2	662533 <b>50586</b>		
11-1/4	2-1/4	6	ME30777	5	QUANTUMX 20-G	662533 <b>50607</b>	86A24-E12VBEP	614636 <b>50279</b>	Gemini 30-E	699366 <b>99706</b>
				5	QUANTUMX 20-H	662533 <b>50608</b>	86A24-G20VTX2	662533 <b>50605</b>	Gemini 30-F	699366 <b>99709</b>
				5	3NQP36-G12VSP	662532 <b>51527</b>			Gemini 30-G	699366 <b>99710</b>
				5			86A30-E12VBEP	614636 <b>50285</b>	Gemini 30-H	662434 <b>47588</b>
				5			86A30-F12VBEP	614636 <b>50287</b>		
				5			86A30-G12VBEP	614636 <b>50289</b>		
11-1/4	2-1/4	8	ME30777	5	QUANTUMX 20-G	662533 <b>50612</b>	86A24-G20VTX2	662533 <b>50609</b>	Gemini 30-E	699366 <b>99712</b>
				5	QUANTUMX 20-H	662533 <b>50615</b>			Gemini 30-F	699366 <b>99716</b>
				5	QUANTUMX 30-E	662533 <b>87810</b>	86A30-E20VTX2	662533 <b>87812</b>	Gemini 30-G	699366 <b>99717</b>
				5	QUANTUMX 30-F	662533 <b>87811</b>	86A30-F20VTX2	662533 <b>87813</b>	Gemini 30-H	662434 <b>47591</b>
				5	3NQP30-F12VSP	662532 <b>38276</b>			Gemini 30-I	662434 <b>47592</b>
				5			86A46-D12VBEP	614636 <b>50442</b>		
11-1/4	3	8	ME100703B	4	QUANTUMX 20-G	662533 <b>50623</b>	86A24-G20VTX2	662533 <b>50617</b>	Gemini 30-E	699366 <b>99725</b>
				4	QUANTUMX 20-H	662533 <b>50624</b>			Gemini 30-F	699366 <b>99727</b>
				4	QUANTUMX 30-E	662533 <b>87808</b>			Gemini 30-G	699366 <b>99728</b>
				4	QUANTUMX 30-F	662533 <b>87809</b>			Gemini 30-H	662434 <b>47594</b>
				4	3NQP30-F12VSP	690831 <b>56473</b>			Gemini 30-I	662434 <b>47595</b>
							Vitrified Burr Remover	614636 <b>50268*</b>		

\*Minimum Quantity = 2



Cylindrical wheels are used most often when the part is held between centers and in chucks. There are three methods of cylindrical grinding: plunge, traverse, and angular.

- Plunge grinding – wheel is thrust or plunged into the part
- Traverse grinding – wheel moves across the part
- Angular grinding – wheel contacts the part at an angle

**Typical Industries:** Automotive, shipbuilding, engine building, bearing, land- and air-based turbine blades, and toolroom

**Shape:** Type 01 Straight, Type 05 Recessed One Side, and Type 07 Recessed 2 Sides

**Size Range:** 16", 18", 20", 24" and 30" diameter

**Abrasive Grain:** Ceramic Alumina and Aluminum Oxide

### Stationary Dressing Tool Recommendations for Cylindrical Wheels

Grinding Wheel Diameter	Diamond Carat Weight	Single Point		Multi-Point (Grit)					
		Tool Product/Part #	0° Angle	Tool Product/Part #	Shape	Tool Product/Part #	Shape		
16" - 20"	3/4	BC7M7	662601 <b>95007</b>	BC62	662601 <b>95012</b>	1/4 x 1/2 Rect.	BC63	662601 <b>95013</b>	1/4 x 1/2 Rect.
		NS7M7	662601 <b>95132</b>	2A6D7	662601 <b>95046</b>		2A6E7	662601 <b>95049</b>	
21" +	1	BC10M7	662601 <b>95009</b>	BC61	662601 <b>95011</b>	1/4 x 3/4 Rect.	BC60	662601 <b>95010</b>	1/4 x 3/4 Rect.
		NS10M7	662601 <b>95137</b>	1A6A7	662601 <b>95031</b>		1A6C7	662601 <b>95039</b>	

*NS Single Point Diamond Tools are resettable. BC Diamond Tools are not resettable. All tools specified above have 7/16" diameter shanks.*

### Troubleshooting Guide

PROBLEM	POSSIBLE CAUSES	SUGGESTED CORRECTION
Burn or cracks on workpiece	Wheel too hard	Try softer wheel or make wheel act softer (see Tech Tip on next page)
	Dress is too fine	Dress faster
	Nozzle not directing coolant properly	Redirect flow
	Work speed too slow or wheel speed too fast	Adjust speeds
	Wheel feed too slow causing excess contact time	Increase feed rate
Chatter marks on workpiece	Loose spindle, end play, bearing failure	Check wheel spindle on assembly
	Work drive faults, out-of-truth plate	Check gear action, truth, drive on pin pressure
	Wheel too hard, poor truing, poor mounting	Use softer grade; dress wheel correctly; secure mounting
Poor quality finish	Poor quality dressing	Reduce final depth of dress on wheel
	Diamond insecurely held	Check and replace diamond and secure properly
	Misalignment of head and tail stocks	Check for properly aligned workpiece
	Dirty coolant	Clean coolant frequently; use efficient filter
	Scored workpiece centers	Check and lap center holes as required

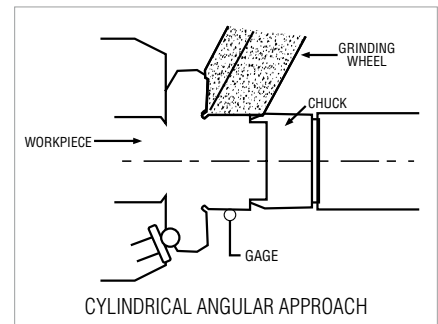
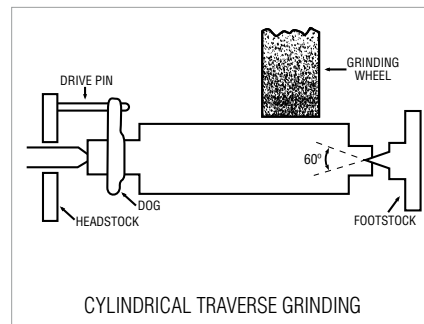
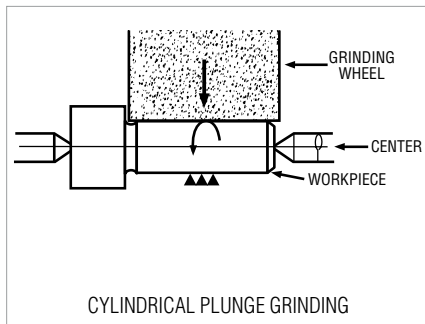

Best choice for highest productivity, lowest total per-part grinding cost

## 5SG CERAMIC ALUMINA/ALUMINUM OXIDE BLEND

- Exceptionally high-performing seeded gel ceramic alumina and friable aluminum oxide abrasive blend for fast stock removal, cool, superior cutting; 3 - 5 times more life than aluminum oxide wheels; 2 times stock removal rate vs. conventional abrasives
- High-performance versatile bond for cylindrical and surface grinding high-speed tool steels, hardened and soft steels, and aerospace alloys: exceptional form holding
- Self-sharpening abrasive minimizes burn and required dressing, to maximize sharp edge on tools and dies for longer life in production

Better choice for medium to heavy stock removal

## 32A ALUMINUM OXIDE

- Exceedingly strong, sharp monocrystalline aluminum oxide grain, for precision production medium to heavy stock removal applications
- The most versatile vitrified bond, especially recommended for toolroom, cylindrical, and surface grinding
- Grinds with an exceptional cool; fast cutting action, requires minimum dressing

Better choice for longer wheel life

## 86A ALUMINUM OXIDE

- Premium abrasive and superior bond system produce high grinding G-Ratios (metal removal/wheel wear) for increased productivity
- Hold form for better part geometry; decreased dress frequency and/or dress compensation
- Engineered for easy use, grind cycles do not need to be altered, no special operator training is needed

Good choice for versatile performance at an economical price

## 64A ALUMINUM OXIDE BLEND

- Specially blended aluminum oxide abrasive for production cylindrical applications
- A superior vitrified bond that maintains high grinding rates without wheel breakdown
- Good choice for small job shops grinding numerous materials on a few machines

Good choice for smallest volume, lowest initial price applications

## GEMINI 2 ALUMINUM OXIDE

- Upgraded aluminum oxide abrasive blend delivers an efficient cut rate and improved grinding wheel life to your precision operations
- Made in the USA, these quality, low initial price wheels are ideal for small- to medium-sized manufacturing facilities that perform a variety of jobs
- Carefully chosen, versatile specifications and sizes meet many cylindrical and surface grinding requirements



		TIER: <b>BEST</b>		BETTER		GOOD	
TRADENAME: <b>5SG</b>		Ceramic Alumina / Aluminum Oxide		Aluminum Oxide		Aluminum Oxide	
SIZE (D x T x H)	STD. PKG.	SPEC.	PART #	SPEC.	PART #	SPEC.	PART #
<b>Type O1 Straight</b>							
16 x 1 x 5	1	5SG60-JVS	662534 <b>67007</b>	32A60-J8VBE	662534 <b>64836</b>	64A60-K8V127	662534 <b>66722</b>
	1			32A60-K5VBE	662534 <b>64837</b>	Gemini2 60-I	662434 <b>97801</b>
	1					Gemini2 60-K	662434 <b>95077</b>
	1					Gemini2 60-M	662434 <b>97802</b>
	1					Gemini2 100-I	662434 <b>97804</b>
	1					Gemini2 100-K	662434 <b>97806</b>
	1					Gemini2 100-M	662434 <b>97807</b>
16 x 1 x 8	1			32A60-K5VBE	662534 <b>64826</b>		
16 x 1-1/2 x 5	1	5SG60-KVS	662534 <b>67010</b>	32A46-H8VBE	662534 <b>64925</b>		
16 x 2 x 5	1			32A46-J8VBE	662534 <b>64995</b>	64A60-K8V127	662534 <b>66721</b>
	1			32A60-K5VBE	662534 <b>64960</b>	Gemini2 60-I	662434 <b>97810</b>
	1					Gemini2 60-K	662434 <b>95078</b>
	1					Gemini2 100-I	662434 <b>97812</b>
16 x 3 x 5	1					Gemini2 100-K	662434 <b>97815</b>
	1					Gemini2 60-I	662434 <b>97820</b>
	1					Gemini2 100-I	662434 <b>97821</b>
18 x 1 x 5	1					Gemini2 60-I	662434 <b>83777</b>
	1					Gemini2 60-K	662434 <b>97610</b>
	1					Gemini2 60-M	662434 <b>97611</b>
	1					Gemini2 100-I	662434 <b>97612</b>
	1					Gemini2 100-K	662434 <b>97613</b>
	1					Gemini2 100-M	662434 <b>97615</b>
	1						
18 x 2 x 5	1					64A60-K8V127	662534 <b>66719</b>
	1					Gemini2 60-I	662434 <b>83779</b>
	1					Gemini2 60-K	662434 <b>97618</b>
	1					Gemini2 100-I	662434 <b>97619</b>
18 x 3 x 5	1					Gemini2 100-K	662434 <b>97620</b>
	1					Gemini2 60-I	662434 <b>83780</b>
	1					Gemini2 100-I	662434 <b>97621</b>
20 x 1 x 8	1			86A60-J8V127	690786 <b>08982</b>	Gemini2 60-I	662434 <b>83782</b>
	1			86A80-J8V127	690786 <b>08983</b>	Gemini2 60-K	662434 <b>97840</b>
	1					Gemini2 60-M	662434 <b>97841</b>
	1					Gemini2 100-I	662434 <b>97842</b>
	1					Gemini2 100-K	662434 <b>97843</b>
	1					Gemini2 100-M	662434 <b>97846</b>
20 x 1 x 10	1					Gemini2 60-I	662434 <b>95332</b>
	1					Gemini2 60-K	662434 <b>97789</b>
	1					Gemini2 60-M	662434 <b>97791</b>
	1					Gemini2 100-I	662434 <b>97793</b>
	1					Gemini2 100-K	662434 <b>97796</b>
	1					Gemini2 100-M	662434 <b>97798</b>
20 x 1 x 12	1					Gemini2 60-I	662434 <b>83787</b>
	1					Gemini2 60-K	662434 <b>97827</b>
	1					Gemini2 60-M	662434 <b>97831</b>
	1					Gemini2 100-I	662434 <b>97835</b>
	1					Gemini2 100-K	662434 <b>97837</b>
	1					Gemini2 100-M	662434 <b>97838</b>
20 x 1-1/2 x 5	1			32A46-H8VBE	690786 <b>65382</b>		
20 x 2 x 5	1					64A60-J8V127	690786 <b>66713</b>
20 x 2 x 8	1			32A46-I8VBE	690786 <b>65433</b>	64A60-K8V127	690786 <b>66712</b>
	1			32A60-K5VBE	690786 <b>65490</b>	Gemini2 60-I	662434 <b>83785</b>
	1					Gemini2 60-K	662434 <b>97855</b>
	1					Gemini2 100-I	662434 <b>97856</b>
	1					Gemini2 100-K	662434 <b>97857</b>
20 x 2 x 10	1					Gemini2 60-I	662434 <b>95334</b>
	1					Gemini2 60-K	662434 <b>97848</b>
	1					Gemini2 100-I	662434 <b>97849</b>
	1					Gemini2 100-K	662434 <b>97850</b>
	1						
20 x 2 x 12	1			32A46-I8VBE	690786 <b>65455</b>	Gemini2 60-I	662434 <b>83788</b>
	1					Gemini2 60-K	662434 <b>97851</b>
	1					Gemini2 100-I	662434 <b>97852</b>
	1					Gemini2 100-K	662434 <b>97854</b>

For additional stock cylindrical wheels, see the large surface grinding wheel section of this catalog

Contact your Norton representative with your custom cylindrical wheel requirements. There are many more sizes and specifications available made-to-your-order, including wheels made from Norton 55A and Quantum blank stock. Our revolutionary Norton Quantum and Vitrium<sup>3</sup> bond ceramic wheels bring a quantum leap in technology to your operation. See 55A and Quantum Blank Stock FastTrack Service catalog sections for more details.



TIER: <b>BEST</b>		<b>BETTER</b>		<b>GOOD</b>	
TRADENAME: <b>55G</b>		<b>32A, 86A</b>		<b>64A, GEMINI, OR GEMINI2</b>	
ABRASIVE: Ceramic Alumina / Aluminum Oxide		Aluminum Oxide		Aluminum Oxide	
SIZE (D x T x H)	STD. PKG.	SPEC.	PART #	SPEC.	PART #
<b>Type 01 Straight</b>					
20 x 3 x 8	1			64A46-18V127	690786 <b>66447</b>
	1			64A60-J8V127	690786 <b>08140</b>
	1			Gemini2 60-I	662434 <b>83786</b>
20 x 3 x 10	1			Gemini2 100-I	662434 <b>97862</b>
	1			Gemini2 60-I	662434 <b>95333</b>
	1			Gemini2 100-I	662434 <b>97859</b>
20 x 3 x 12	1			Gemini2 60-I	662434 <b>83789</b>
	1			Gemini2 100-I	662434 <b>97860</b>
	1			Gemini2 60-I	662434 <b>83790</b>
24 x 1 x 12	1			Gemini2 60-K	662434 <b>97863</b>
	1			Gemini2 100-I	662434 <b>97866</b>
	1			Gemini2 100-K	662434 <b>97868</b>
	1			Gemini2 100-M	662434 <b>97870</b>
	1			Gemini2 60-I	662434 <b>97871</b>
24 x 2 x 12	1			64A60-K8V127	690831 <b>66710</b>
	1			64A80-K8V127	690831 <b>66711</b>
	1			Gemini2 60-I	662434 <b>83792</b>
	1			Gemini2 60-K	662434 <b>97872</b>
	1			Gemini2 100-I	662434 <b>97873</b>
24 x 3 x 12	1			Gemini2 100-K	662434 <b>97874</b>
	1			Gemini2 60-I	662434 <b>83793</b>
	1			Gemini2 100-I	662434 <b>97877</b>
30 x 2 x 12	1			64A60-J8V127	692104 <b>66704</b>
	1			Gemini2 60-J	662434 <b>97878</b>
	1			Gemini2 60-L	662434 <b>97986</b>
30 x 3 x 12	1			64A60-J8V127	692104 <b>66697</b>
	1			64A60-K8V127	692104 <b>66698</b>
	1			Gemini2 60-J	662434 <b>97987</b>
	1			Gemini2 60-L	662434 <b>97988</b>
	1			64A60-J8V127	692104 <b>01774</b>
30 x 4 x 12	1			Gemini2 60-J	662434 <b>97989</b>
	1			Gemini2 60-L	662434 <b>97990</b>
	1				
<b>Type 07 Recessed Two Sides</b>					
18 x 2 x 8	1		32A46-18VBE	662534 <b>65110</b>	
Rec 2/S 10-1/2 x 1/2					
20 x 2 x 8	1		32A46-18VBE	690786 <b>65537</b>	
Rec 2/S 11-1/2 x 1/2					
20 x 3 x 8	1		32A46-18VBE	690786 <b>65686</b>	
Rec 2/S 11-1/4 x 1/2					
20 x 3 x 8	1			Gemini 46-H	662532 <b>46969</b>
Rec 2/S 11-1/2 x 1/2					
20 x 3 x 10	1		32A46-18VBE	690786 <b>65575</b>	
Rec 2/S 12-1/4 x 5/8					
20 x 6 x 10	1		32A46-18VBE	690786 <b>65854</b>	
Rec Side A 12-1/4 x 2					
Rec Side B 12-1/4 x 1					

For additional stock cylindrical wheels, see the large surface grinding wheel section of this catalog

Contact your Norton representative with your custom cylindrical wheel requirements. There are many more sizes and specifications available made-to-your-order, including wheels made from Norton 55A and Quantum blank stock. Our revolutionary Norton Quantum and Vitrium<sup>3</sup> bond ceramic wheels bring a quantum leap in technology to your operation. See 55A and Quantum Blank Stock FastTrack Service catalog sections for more details.

### TECH TIP

To make a wheel act softer:

- Increase work speed
- Increase traverse speed
- Increase infeed
- Decrease wheel speed
- Increase dresser traverse rate
- Increase depth of dress per traverse
- Dress more often

To make a wheel act harder:

- Decrease work speed
- Decrease traverse speed
- Decrease infeed
- Increase wheel speed (do not exceed MAX RPM marked on wheel)
- Dress at slower traverse rate
- Decrease depth of dress per traverse



It is the user's responsibility to refer to and comply with ANSI B7.1



Centerless grinding is a production process that produces extremely close tolerances on metal cylindrical forms or parts. Centerless grinding is used on a wide variety of workpieces. The key components in the process are the grinding wheel, the work rest blade (used to support the work) and the regulating or “feed” wheel (the drive mechanism for the workpiece).

**Applications:**

- High production operations on large volume continuous grinding
- Parts ranging from miniature roller bearings to train axles and bearings
- Fastener and tool manufacturing
- Steel mills
- Automotive related components
- Bearing
- Machine tools
- Aircraft
- Turbine blades – land- and air-based

**Shape:**

Centerless wheels: Type 01 Straight  
 Feed wheels: Type 01 Straight and Type 07 Recessed 2 Sides

**Size Range:**

Centerless wheels: 16", 20", and 24" diameter  
 Feed wheels: 12" and 14" diameter

**Abrasive Grain:**

Ceramic Alumina, Aluminum Oxide, Aluminum Oxide/Silicon Carbide Blend

### Material-to-Product Recommendation Guide

	55A60-KVS3	55A80-LVS3	32AC90-QB	32AC54-QB	2NQMC54-QB45
<b>Alnico</b>	◆			◆	
<b>Cast Iron</b>	◆			◆	
<b>Hastalloy</b>	◆				
<b>Inconel</b>	◆				
<b>Stainless</b>	◆				
<b>Stainless Steel 300</b>	◆				
<b>Stainless Steel 400</b>	◆				
<b>Steel - Hard or Soft</b>					
Less than 1/2" Diameter		◆			
5/8" to 2 1/2" Diameter	◆				
Over 2 1/2" Diameter	◆				◆
High Speed (commercial finish)	◆				◆
High Speed (fine finish)			◆		

### Stationary Dressing Tool Recommendations for Centerless Wheels

Grinding Wheel Diameter	Diamond Carat Weight	Single Point		Indexable Single Point		Multi-point (Grit)	
		Tool Product # Part # 0° Angle	Tool Product # Part # 0° Angle	Tool Product # Part # 0° Angle	Shape	Tool Product # Part # 15° Angle	Shape
11" - 14"	1/2	BC5M7 662601 <b>95005</b>	BCUD5 662601 <b>95025</b>	BC65 662601 <b>95015</b>	3/8 Round	BC63 662601 <b>95013</b>	1/4 x 1/2
		NS5M7 662601 <b>95127</b>	NSUD5 662601 <b>95163</b>	2R6K7 662601 <b>95096</b>		2A6E7 662601 <b>95049</b>	
15" - 20"	3/4	BC7M7 662601 <b>95007</b>	N/A	BC62 662601 <b>95012</b>	1/4 x 1/2	BC63 662601 <b>95013</b>	1/4 x 1/2
		NS7M7 662601 <b>95132</b>	NSUD7 662601 <b>95164</b>	2A6D7 662601 <b>95046</b>		Rectangle	
21" +	1	BC10M7 662601 <b>95009</b>	N/A	BC61 662601 <b>95011</b>	1/4 x 3/4	BC60 662601 <b>95010</b>	1/4 x 3/4
		NS10M7 662601 <b>95137</b>	NSUD10 662601 <b>95165</b>	1A6A7 662601 <b>95031</b>		Rectangle	

### Stationary Dressing Tool Recommendations for Feed Wheels

Feed Wheel Diameter	Tool Carat Weight	Tool Shank Diameter	Indexable Single Point	
			Tool Product #	Tool Part #
Up to 14"	1/2	7/16"	NSUD5	662601 <b>95163</b>

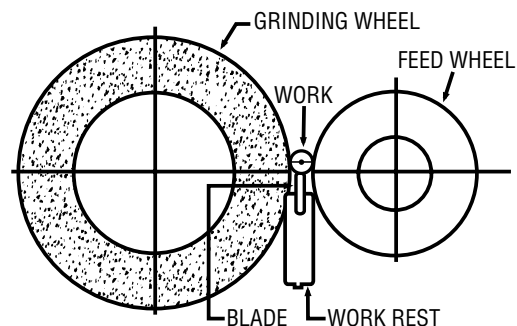

## TECH TIP

### Proper Wheel Mounting

1. Thoroughly clean spindle and flange bearing area of all dirt and foreign material.
2. Inspect for worn, distorted or damaged areas on flanges and spindle.
3. If mounting a wide centerless wheel on a spindle (i.e., twin-grip), do not use grease or other petroleum lubricants. Use a silicone spray lubricant on the spindle to ease mounting the wheel, if necessary.
4. Ensure mount up arrow is at the top of the wheel. In the case of butted sets, assemble so that the arrow is formed across the top of the wheel face.
5. Ensure proper blotters are installed; one on each flange mating surface. Always use new blotters.
6. Install blotter flange and snug up the bolts only finger tight.
7. Using a torque wrench, tighten all bolts in an alternating pattern from side to side to 15 foot pounds.
8. Repeat the same tightening sequence, increasing the torque to 35 foot pounds.
  - » for wide wheels (18"-20"), torque the bolts at 45 to 50 foot pounds
  - » for narrower wheels (2"-12"), a torque of 35 foot pounds is sufficient
9. Retorque the flange bolts to specification after the first eight hours of operation.

## TECH TIP

- Use vitrified bond wheels for form holding and plunge grinding
- Use resinoid bond wheels for stock removal, long irregular parts and faster throughfeed grinding
- Vitrified Centerless Wheel Speeds:
  - » 64A46-KVCE wheels: 6,500 SFPM max. operating speed
  - » All other vitrified centerless stock products: 8,500 SFPM max. operating speed
  - » Always check wheel speed markings on wheels before running wheel



It is the user's responsibility to refer to and comply with ANSI B7.1

## TECH TIP

### To make a wheel act softer:

- Increase work speed/regulating wheel speed
- Increase throughput speed/regulating wheel speed
- Increase infeed
- Decrease wheel speed
- Dress at a faster traverse rate

### To make a wheel act harder:

- Decrease work speed/regulating wheel speed
- Decrease throughput speed/regulating wheel speed
- Decrease infeed
- Increase wheel speed (observe safe limits)



Best choice for cast iron to stainless and hard-to-grind materials and alloys (titanium, Inconel...)

## QUANTUM (2NQ) CENTURY45 CERAMIC ALUMINA

- Proprietary 2NQ ceramic abrasive and Century45 (B45) resin bond formulation engineered specifically to maximize productivity of centerless applications
- Achieve over 30% improvement of stock removal, and up to 50% reduction in cycle time
- Less grinding noise significantly improves operator safety

Better choice for performance to price ratio



## 55A-VS3 ALUMINUM OXIDE

- Monocrystalline 55A aluminum oxide offers superior performance on centerless plunge and throughfeed surface grinders with 2 plus times the life of competitive aluminum oxide wheels
- Vitrium 3 VS3 bond allows cool cutting, high-speed, and precise form holding
- Ideal for simple- to complex-shaped components, with increased productivity; more quality parts at low cost per part

Better choice when one wheel is used to grind several different materials

## 32AC ALUMINUM OXIDE / SILICON CARBIDE BLEND

- Aluminum oxide/silicon carbide abrasive blend in a strong resin bond is ideal when one wheel is used to grind several different materials from high-to-low tensile strength
- Norton resin bond centerless wheels are the choice for stock removal, long irregular paths, and faster through feed grinding
- Ideal for full range of simple- to complex-shaped components

Good choice for hard-to-grind fasteners

## 57A ALUMINUM OXIDE WITH FINE / HARD SIDE

- Tough, durable aluminum oxide abrasive for heavy duty work
- Superior vitrified bond system for longer wheel life and excellent form holding when toolroom and centerless grinding
- 3/16 inch thick fine/hard side provides good form holding while grinding stainless and Inconel fasteners

Good choice for grinding a variety of materials, economically

## 64A ALUMINUM OXIDE BLEND

- Good intermediate type aluminum oxide abrasive blend for production centerless applications
- A superior vitrified bond that maintains high grinding rates without wheel breakdown
- Good choice for small job shops grinding numerous materials on a few machines

Good choice for smallest volume, lowest initial price applications

## GEMINI 2 ALUMINUM OXIDE

- Upgraded aluminum oxide abrasive blend delivers an efficient cut rate and improved grinding wheel life to your precision operations
- Made in the USA, these quality, low initial price wheels are ideal for small- to medium-sized manufacturing facilities that perform a variety of jobs
- Carefully chosen, versatile specifications and sizes meet many centerless grinding requirements

### Centerless Wheels

		TIER: <b>BEST</b>		BETTER		BETTER		EXPANDED OFFERING		GOOD	
TRADENAME:		<b>QUANTUM CENTURY45</b>		<b>32AC / 32AC CENTURY 45</b>		<b>55A</b>		<b>53A, 57A, 64A, GEMINI, GEMIN2</b>		<b>CENTERLESS RESINOID WHEELS</b>	
ABRASIVE:		Ceramic Alumina		Aluminum Oxide/Silicon Carbide		Aluminum Oxide		Aluminum Oxide		Aluminum Oxide	
SIZE (D x T x H)	STD. PKG.	SPEC.	PART #	SPEC.	PART #	SPEC.	PART #	SPEC.	PART #	SPEC.	PART #
<b>Type 01 Straight</b>											
16 x 4 x 10	1							57A80-L8VCN	662534	<b>65001</b>	
20 x 2 x 12	1										
20 x 4 x 12	1							64A60-KVCE	690786	<b>66723</b>	
	1							64A80-LVCE	690786	<b>66727</b>	
20 x 6 x 12	1	2NQMC54-QB45	662434 <b>96406</b>	32AC80-NB45	662434 <b>96398</b>	55A60-KVS3	662533 <b>87817</b>	64A60-KVCE	690786	<b>66729</b>	
	1			32AC54-QB	690786 <b>66545</b>	55A80-LVS	662534 <b>90781</b>	Gemini 60-L	662532	<b>46994</b>	
	1					55A80-MVS	662534 <b>90788</b>				
20 x 8 x 12	1	2NQMC54-QB45	662434 <b>96407</b>	32AC80-NB45	662434 <b>96400</b>	55A60-KVS3	662533 <b>87819</b>	64A60-KVCE	690786	<b>66748</b>	
	1			32AC54-QB	690786 <b>66546</b>	55A80-LVS	662534 <b>90783</b>	64A60-LVCE	690786	<b>66749</b>	
	1					55A80-MVS	662534 <b>90785</b>	64A80-KVCE	690786	<b>66751</b>	
	1							Gemini 54-J	662532	<b>47001</b>	
	1							Gemini2 60-K	662534	<b>51857</b>	
24 x 1-1/2 x 12	1							57A 80/120 O/Q	662531	<b>193575</b>	
w/ 3/16" fine/hard layer	1							57A 80/120 P/R	662533	<b>54449</b>	
24 x 2-1/2 x 12	1							57A A80/120 P/R	662534	<b>91223</b>	
24 x 2-1/2 x 12	1							57A 80/120 O/Q	662532	<b>85629</b>	
w/ 3/16" fine/hard layer	1							57A 80/120 P/R	662533	<b>40540</b>	
24 x 3 x 12	1							64A60-K8V127	690831	<b>66708</b>	
24 x 4 x 12	1							Gemini2 60-K	662534	<b>51860</b>	
	1							Gemini2 100-L	662534	<b>51861</b>	
24 x 6 x 12	1	2NQMC54-QB45	662434 <b>96408</b>	32AC80-NB45	662434 <b>96401</b>	55A80-LVS3	662533 <b>87821</b>	Gemini 60-K	662532	<b>47047</b>	
	1			32AC54-QB	690831 <b>66547</b>			Gemini2 60-K	662534	<b>51862</b>	
24 x 8 x 12	1	2NQMC54-QB45	662434 <b>96409</b>	32AC80-NB45	662434 <b>96403</b>	55A60-KVS	662534 <b>90791</b>	Gemini2 60-K	662534	<b>51864</b>	
	1			32AC54-QB	690831 <b>66548</b>	55A60-LVS	662534 <b>90762</b>				
	1					55A80-LVS3	662533 <b>87825</b>				
	1					55A60-MVS	662534 <b>90782</b>				
24 x 10 x 12	1	2NQMC54-QB45	662434 <b>96410</b>	32AC80-NB45	662434 <b>96404</b>	55A60-KVS3	662533 <b>87830</b>	Gemini2 60-K	662534	<b>51866</b>	
	1			32AC54-QB	690831 <b>66549</b>	55A80-LVS3	662533 <b>87828</b>				
24 x 20 x 12	1			32AC54-QB	690831 <b>66552</b>						
Composed of 2 Wheels	1			32AC54-SB	690831 <b>66553</b>						
10" Thick (ME90362)											

### Rubber Bond Feed Wheels

		TIER: <b>BETTER</b>	
ABRASIVE:		Aluminum Oxide	
SIZE (D x T x H)	STD. PKG.	SPEC.	PART #
<b>Type 01 Straight</b>			
12 x 2 x 5	1	57A80-RR51	662532 <b>22840</b>
<b>Type 07 Recessed Two Sides</b>			
12 x 4 x 5	1	57A80-RR51	662532 <b>22844</b>
Rec 2 Sides 7-1/2 x 1/2			
12 x 6 x 5	1	57A80-RR51	662532 <b>22846</b>
Rec Side A 7-1/2 x 1-1/2			
Rec Side B 7-1/2 x 1/2			
12 x 6 x 5	1	57A80-RR51	662532 <b>22847</b>
Rec 2 Sides 7-1/2 x 1-1/2			
12 x 8 x 5	1	57A80-RR51	662532 <b>22850</b>
Rec Side A 7-1/2 x 2-1/2			
Rec Side B 7-1/2 x 1-1/2			
14 x 8 x 5	1	57A80-RR51	662533 <b>22859</b>
Rec Side A 8 x 2			
Rec Side B 8 x 1-1/2			
14 x 20 x 6	1	57A80-RR51	662533 <b>22196</b>
Rec 2 Sides 8-1/2 x 1-1/2			
Butted Feed Wheels			
Composed of 2 Wheels			
10" Thick (ME91512)			

### Plastic Bond Feed Wheels

		TIER: <b>BETTER</b>	
ABRASIVE:		Aluminum Oxide	
SIZE (D x T x H)	STD. PKG.	SPEC.	PART #
<b>Type 07 Recessed Two Sides</b>			
12 x 8 x 5	1	57A80-RP4	662532 <b>22199</b>
Rec Side A 7-1/2 x 2-1/2			
Rec Side B 7-1/2 x 1-1/2			

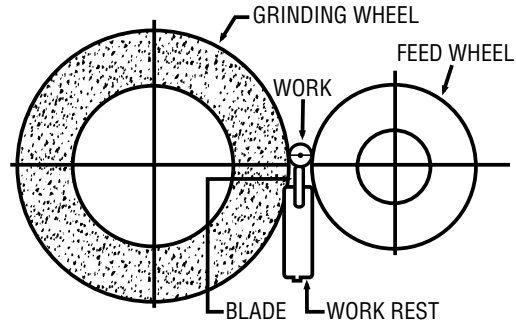

There are many more sizes and specifications available made-to-your-order, including wheels made from our blank stock FastTrack Service for rush orders. Contact your Norton representative with your custom centerless requirements.

# Creepfeed Blank Stock FastTrack Service



Norton creepfeed wheels are the best performing creepfeed wheels in the industry. These high-performance blank stock wheels can be altered to your dimensional requirements.

- Applications:** Heat-sensitive, porous grinding of difficult-to-grind alloys
- Typical Industries:** Aerospace, automotive, toolroom, gear, energy
- Size Range:** Blank Stock: 16" – 25" diameter  
Finished Wheel: 14" – 25" diameter
- Grade/Porosity:** C28 – F26
- Abrasive Grain:** Ceramic Alumina, Fused Aluminum Oxide

**Best choice for versatility, maximum performance, and highest productivity**



## QUANTUM X CERAMIC ALUMINA AND VORTEX ALUMINUM OXIDE BLEND

- Leading Norton technologies produce the most free-cutting creepfeed wheel: patented pore-induced construction, a blend of Norton Quantum ceramic and Vortex aluminum oxide abrasives, and the newest, strongest Norton bond: Vitrium
- Excel on large area of contact applications with exceptional form and corner-holding and 20+% less power draw; best MRR vs. all other ceramic creepfeed wheels, with reduced cycle times of up to 50%
- Versatile; for all low-, medium- and high-force applications on hard-to-grind Inconel, titanium, and aerospace alloys

**Better choice for heat-sensitive, porous grinding of difficult-to-grind alloys**



## VORTEX ENGINEERED ALUMINUM OXIDE

- High-performance, engineered and optimally spaced fused aluminum oxide abrasive
- High metal removal rates; able to grind large areas of contact with exceptional part integrity and quality and superior surface finish
- Long wheel life: dramatically shorter grinding cycles = less wheel changes and more parts/wheel = high productivity

### Key Program Features

- Standard lead-time: 2 weeks
- Alteration Parameters:
  - » Diameter may be altered to 2" smaller than the original blank stock diameter
  - » Thickness may be altered to 1/2 the original blank stock thickness
  - » Bore may be altered to these parameters 5" altered up to 8" max. 8" altered up to 12" max.

TIER: <b>BEST</b>		BETTER		
TRADENAME: <b>QUANTUM X 3NQX, TG CERAMIC UNFINISHED BLANK STOCK</b>		<b>VORTEX A/O UNFINISHED BLANK STOCK</b>		
SIZE (D x T x H)	SPEC.	UF BLANK PART #	SPEC.	UF BLANK PART #
<b>Type O1 Straight</b> 				
12 x 1.750 x 3	3NQX60/1-D24VTX2	003105	<b>01586</b>	
12 x 3.500 x 3	3NQX60/1-E24VTX2	003105	<b>01589</b>	
12 x 1 x 3	3NQX60/1-E24VTX2	003105	<b>01590</b>	
12 x 3 x 3	TG2120/1-E24VTX2	003105	<b>01591</b>	
12 x 3.500 x 3	3NQX60/1-C28VTX2	003105	<b>03234</b>	
12 x 1.500 x 3	3NQX60/1-C28VTX2	003105	<b>03235</b>	
16 x 1 x 5	3NQX60-C28VTX2	003104	<b>38575</b>	
	3NQX60-D28VTX2	003104	<b>25238</b>	
	3NQX60-D+28VTX2	003104	<b>79157</b>	
	3NQX60-E24VTX2	003104	<b>25239</b>	
	3NQX80-E+28VTX2	003104	<b>79160</b>	
16 x 3 x 5	3NQX60-C28VTX2	003104	<b>38656</b>	
	3NQX60-D28VTX2	003104	<b>25240</b>	
	3NQX60-D+28VTX2	003104	<b>79158</b>	
	3NQX60-E24VTX2	003104	<b>25241</b>	
	3NQX80-D+28VTX2	003104	<b>79163</b>	
16 x 4 x 5				IPA60-D29VTX 003103 <b>12485</b>
				IPA60-E26VTX 003103 <b>12486</b>
16 x 5 x 5	3NQX60-D28VTX2	003104	<b>25242</b>	
	3NQX60-E24VTX2	003104	<b>25243</b>	
16 x 6 x 5	3NQX60-C28VTX2	003104	<b>38657</b>	
	3NQX80-D+28VTX2	003104	<b>79164</b>	
	3NQX80-E+28VTX2	003104	<b>79162</b>	
20 x 1 x 8	3NQX60-C28VTX2	003104	<b>38658</b>	
	3NQX60-D28VTX2	003104	<b>25244</b>	
	3NQX60-E24VTX2	003104	<b>25245</b>	
20 x 2-1/2 x 8				IPA60-E26VTX 003103 <b>03130</b>
				IPA60-F17VTX 003103 <b>03131</b>
				IPA80-D29VTX 003103 <b>03132</b>
20 x 3 x 8	3NQX60-C28VTX2	003104	<b>38659</b>	
	3NQX60-D28VTX2	003104	<b>25256</b>	
	3NQX60-E24VTX2	003104	<b>25257</b>	
20 x 4 x 8				IPA60-D29VTX 003103 <b>03133</b>
				IPA60-E26VTX 003103 <b>03134</b>
20 x 5 x 8	3NQX60-D28VTX2	003104	<b>25258</b>	
	3NQX60-E24VTX2	003104	<b>25259</b>	
20 x 6 x 8	3NQX60-C28VTX2	003104	<b>38660</b>	
24 x 4 x 8				IPA60-C29VTX 031039 <b>25091</b>
				IPA60-D29VTX 003104 <b>06547</b>
				IPA60-F26VTX 003103 <b>03135</b>
25 x 2-1/2 x 8				IPA60-E26VTX 003104 <b>04613</b>
25 x 3-1/2 x 8				IPA60-E26VTX 003104 <b>04678</b>



# Quantum Blank Stock FastTrack Service



The newest-generation ceramic Norton Quantum vitrified wheels deliver the highest productivity of any wheel in the marketplace. They will grind with superior results in many applications. They can be altered to your specific needs within two weeks of receipt of your order.

- Applications:**
- Centerless plunge and throughfeed grinding
  - Surface grinding
  - Cylindrical grinding
- Size Range:**  
Blank Stock: 18" – 30" diameter  
Finished Wheel: 16" – 30" diameter
- Grit Range:** 60, 80, and 120
- Grade Range:** I – M
- Abrasive Grain:** Ceramic Alumina

Best choice for versatility, maximum performance, and cost savings



## QUANTUM CERAMIC ALUMINA

- Revolutionary, sharp, durable engineered ceramic alumina grain shape and chemistry; highly-porous
- Perform well on old and new machines with 30%+ higher metal removal rate and 15%+ lower threshold power; achieve highest productivity with lowest total grinding cost
- Versatile; for all low-, medium- and high-force applications ranging from cast iron, to stainless steel and hard-to-grind Inconel and titanium

TIER: **BEST**

TRADENAME: **QUANTUM CERAMIC UNFINISHED BLANK STOCK**

SIZE (D x T x H)	SPEC.	UNFINISHED BLANK PART #
<b>Type 01 Straight</b>		
18 x 1 x 5	3NQ80-K10VS	003104 <b>05993</b>
18 x 2 x 5	3NQ80-K10VS	003104 <b>05994</b>
18 x 3 x 5	3NQ80-K10VS	003104 <b>05995</b>
20 x 1 x 8	3NQ80-K10VS	003104 <b>05985</b>
20 x 1 x 12	3NQ80-K10VS	003104 <b>06017</b>
	3NQ120-MVS	003104 <b>05924</b>
20 x 2 x 8	3NQ80-K10VS	003104 <b>06036</b>
20 x 3 x 8	3NQ80-K10VS	003104 <b>06037</b>
20 x 6 x 12	3NQ80-L10VS	003104 <b>06018</b>
20 x 8 x 12	3NQ80-L10VS	003104 <b>06026</b>
24 x 1 x 8	3NQ80-K10VS	003104 <b>06034</b>
24 x 1 x 12	3NQ80-K10VS	003104 <b>06038</b>
24 x 2 x 8	3NQ80-K10VS	003104 <b>06035</b>
24 x 2 x 12	3NQ80-K10VS	003104 <b>06029</b>
24 x 3 x 8	3NQ60-J10VS	003104 <b>25121</b>
	3NQ80-K10VS	003104 <b>06046</b>
24 x 3 x 12	3NQ60-J10VS	003104 <b>25120</b>
	3NQ80-K10VS	003104 <b>06030</b>
24 x 6 x 12	3NQ80-L10VS	003104 <b>06031</b>
24 x 8 x 12	3NQ80-L10VS	003104 <b>06032</b>
24 x 10 x 12	3NQ80-L10VS	003104 <b>06033</b>
30 x 2 x 12	3NQ80-I10VS	003104 <b>27211</b>
	3NQ80-J10VS	003104 <b>06047</b>
	3NQ80-K10VS	003104 <b>06048</b>
30 x 3 x 12	3NQ60-I10VS	003104 <b>27212</b>

There are many finished sizes and specifications available. Contact your local Norton distributor or salesperson with your size and specification requirements for quantity guidelines, quotations and helpful ordering instructions.

Please note "2-week delivery request" if needed, on your order.



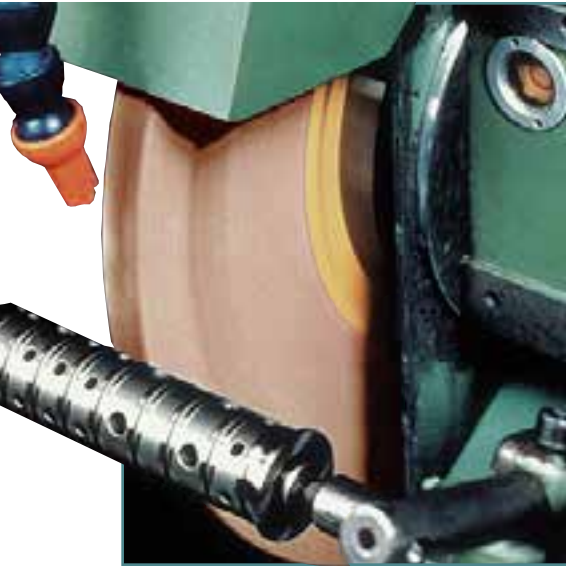

55A-VH blank stock wheels are competitively-priced, monocrystalline grain wheels specifically engineered for numerous carbon steel applications requiring moderate to heavy stock removal rates. They can be altered to your specific needs within two weeks of receipt of your order.

- Applications:** Centerless plunge and throughfeed grinding  
Surface grinding  
Cylindrical grinding
- Size Range:** Blank Stock: 18" – 42" diameter  
Finished Wheel: 16" – 42" diameter
- Grit Range:** 60 – 120
- Grade Range:** I – M
- Abrasive Grain:** Aluminum Oxide

Better choice for precision grinding of carbon steel and cast iron



### 55A-VH ALUMINUM OXIDE

- Advanced combination of monocrystalline 55A aluminum oxide abrasive and superior VH bond
- Superior performance on centerless plunge and throughfeed, surface, and cylindrical grinders with up to 2X the life of competitive aluminum oxide wheels
- Ideal for simple- to complex-shaped components with increased productivity, more quality parts, and lowest cost per part

TIER: **BETTER**  
OTHER: **55A-VH ALUMINUM OXIDE UNFINISHED BLANK STOCK**

SIZE (D x T x H)	GRIT	GRADE	UNFINISHED BLANK PART #
<b>Type 01 Straight</b>			
18 x 1 x 5	80	K	003104 <b>04552</b>
18 x 2 x 5	80	K	003104 <b>04554</b>
18 x 3 x 5	80	K	003104 <b>04555</b>
20 x 1 x 8	60	K	003100 <b>20910</b>
20 x 1 x 12	100	K	003103 <b>02177</b>
	120	K	003103 <b>02220</b>
	120	M	003100 <b>64512</b>
20 x 1-1/2 x 12	80	K	003103 <b>02221</b>
	100	K	003103 <b>02222</b>
20 x 2 x 8	80	K	003100 <b>20918</b>
	100	K	003100 <b>20920</b>
	120	M	003100 <b>64252</b>
20 x 3 x 8	80	K	003104 <b>25116</b>
20 x 3 x 12	80	K	003104 <b>25117</b>
20 x 6 x 12	80	K	003100 <b>20965</b>
24 x 1 x 8	80	K	003100 <b>21884</b>
24 x 1 x 12	60	K	003100 <b>20921</b>
	80	M	003100 <b>20923</b>
24 x 1-1/4 x 12	60	M	003103 <b>02224</b>
24 x 1-1/2 x 8	80	K	003103 <b>02223</b>
24 x 1-1/2 x 12	80	K	003103 <b>02225</b>
	80	M	003103 <b>02226</b>
24 x 2 x 8	80	K	003100 <b>21885</b>
24 x 2 x 12	60	K	003100 <b>20924</b>
	80	I	003100 <b>20926</b>
24 x 3 x 8	80	K	003100 <b>21757</b>
24 x 5 x 12	60	L	003103 <b>02227</b>
24 x 6 x 12	60	K	003100 <b>20968</b>
24 x 8 x 12	100	K	003103 <b>02228</b>
24 x 10 x 12	80	K	003100 <b>20972</b>
30 x 2 x 12	60	L	003100 <b>20929</b>
30 x 3 x 12	60	L	003100 <b>20930</b>
42 x 1-1/2 x 12	60	M	003100 <b>20931</b>

There are many finished sizes and specifications available. Contact your local Norton distributor or salesperson with your size and specification requirements for quantity guidelines, quotations and helpful ordering instructions.

*Please note "2-week delivery request" if needed, on your order.*

# Gear Wheel Blank Stock FastTrack Service



Norton quality non-stock gear wheels are designed to produce high metal removal rates with less power draw. The blank stock wheels below comprise our FastTrack alteration service. All Norton FastTrack wheels are altered on state-of-the-art CNC controlled machines and are finished using Norton dressing wheels. The Norton dressing wheels and machines give these wheels excellent accuracy and repeatability.

## Vitrium<sup>3</sup> VS3G Bond Wheels

Our revolutionary, exclusive bond platform provides unprecedented wheel performance and finished part accuracy across many precision grinding applications – while lowering process time and cost in three ways:

1. Coolest cutting with maximum chip clearance
2. Optimized precision profile delivers ultra radius accuracy
3. Able to run at higher operating speeds (maximizing your older and newer machines' performances)

<b>Size Range:</b>	Blank Stock: 120mm – 450mm diameter Finished Wheel: 115mm – 450mm diameter
<b>Grit Range:</b>	60 – 120
<b>Abrasive Grain:</b>	Ceramic Alumina and Aluminum Oxide

## Key Program Features

- Standard lead time:
  - » 2 weeks
- Alteration Parameters:
  - » Diameter may be altered to 2" smaller than the original blank stock diameter
  - » Thickness may be altered to 1/2 the original blank stock thickness

Best choice for versatility, highest productivity, and lowest total cost

## QUANTUM X CERAMIC ALUMINA AND VORTEX ALUMINUM OXIDE BLEND

- Leading Norton technologies produce the most free-cutting gear wheels: patented pore-induced construction, Norton Quantum X ceramic alumina and Vortex aluminum oxide abrasive blend, and strong Norton bond
- Best MRR (metal removal rate) versus all other ceramic gear wheels; reduce grinding cycle times up to 50%, best choice for grinding from solid
- Versatile; for all low-, medium- and high-force applications on hard-to-grind Inconel, titanium, and aerospace alloys; excel on large area of contact applications with exceptional form and corner-holding; 20+% less power draw

Excellent choice for the most demanding operations

## TARGA TG, 3TG, 5TG CERAMIC ALUMINA

- The unique elongated shape of our second generation Norton seeded gel ceramic alumina abrasive offers exceptional durability for the most demanding applications and materials
- Consider Targa (TG) when your requirements for SG have been exceeded
- VS3G Vitrium<sup>3</sup> bond is the newest, strongest bond in the Norton portfolio: patented pore-induced construction; for all low-, medium- and high-force applications; excels on hard-to-grind aerospace alloys and large areas of contact; exceptional form and corner-holding

Excellent choice for high productivity, low total per-part grinding cost

## SG CERAMIC ALUMINA

- High-performance seeded gel ceramic aluminum oxide abrasive provides fast stock removal, cool, superior cutting, and 3X - 5X more life than aluminum oxide wheels, and double rough stock removal rate versus conventional abrasives
- Self-sharpening abrasive for less burn, less dressing; very consistent performing wheel
- 5SG – durable Norton SG and aluminum oxide blend – blue, for high stock removal rates, excellent productivity, long wheel life, low overall grinding cost; versatile, high-performance VS and VSP bonds provide exceptional form holding

Better choice for versatile, consistent performance

## 86A ALUMINUM OXIDE

- Sharper aluminum oxide abrasive for cooler cutting
- VS3G Vitrium<sup>3</sup> bond is the newest, strongest bond in the Norton portfolio: patented pore-induced construction; for all low-, medium- and high-force applications
- Excels on hard-to-grind aerospace alloys and large areas of contact; exceptional form and corner-holding

TIER:	BEST		BEST		BETTER		BETTER	
TRADENAME:	<b>NORTON QUANTUM X: 5NQX</b> <b>NORTON QUANTUM:</b> <b>NQ, 3NQ, 5NQ</b> <b>VS3G = VITRIUM<sup>3</sup> BOND</b>		<b>NORTON SEEDED GEL:</b> <b>3TGP, SG, 5SG</b> <b>VS3G = VITRIUM<sup>3</sup> BOND</b>		<b>BRGL</b> <b>VS3G = VITRIUM<sup>3</sup> BOND</b>		<b>86A, 25A, X25A</b> <b>VS3G = VITRIUM<sup>3</sup> BOND</b>	
ABRASIVE:	Ceramic Alumina Unfinished Blank Stock		Ceramic Alumina Unfinished Blank Stock		BRGL – Ceramic Alumina Unfinished Blank Stock		86A, 25A, X25A – Aluminum Oxide Unfinished Blank Stock	
SIZE (D x T x H)	SPEC.	BLANK PART #	SPEC.	BLANK PART #	SPEC.	BLANK PART #	SPEC.	BLANK PART #
<b>Type O1 Straight</b> 								
<b>Worm Profile Wheels</b>								
220mm x 180mm x 76.2mm					BRGL80-GVPHS	00310048274		
275mm x 125mm x 160mm							86A90-J10VS3G	00310477165
							86A100/5-110VTX2	00310458402
275mm x 160mm x 160mm	5NQM90-J10VS3G	00310491163					86A90-J10VS3G	00310486397
							25A100-110VS3G	00310460909
280mm x 160mm x 115mm	NQ80-H8VS3G	00310448492	SG80-HVX	00310419856			X25A70-G16VPAP	00310410369
							25A80-H8VS3G	00310448494
							86A80-H10VS3G	00310470137
300mm x 125mm x 160mm	3NQ90-J10VH	00310394338					86A100/5-J10VTX2	00310458405
	3NQ90-J10VS3G	00310477165					86A100/5-110VTX2	00310458404
300mm x 160mm x 160mm							86A90-J10VS3G	00310486981
							86A120-J10VS3G	00310486983
320 x 125 x 115	NQ80-H8VS3G	00310472371						
350mm x 104mm x 160mm					BRGL80-GVPHS	00310066976		
					BRGL100-GVPLS	00310066991		
350mm x 125mm x 160mm	3NQ90-H10VS3G	00310448495					25A90-H10VS3G	00310448496
<b>Single Rib Wheels</b>								
120mm x 30mm x 20mm	5NQX100-G20VTX2	00310490920	3TGP80/3-G12VS3G	00310448502				
300mm x 30mm x 50.8mm	5NQX60-G20VTX2	00310490863	3TGP80/3-G12VS3G	00310448501				
300mm x 60mm x 50.8mm	5NQX60-G20VTX2	00310490864	3TGP80/3-G12VS3G	00310448500				
400mm x 50mm x 127mm			3TGP60-G20VSPF	00310404596				
400mm x 60mm x 127mm	5NQX60-G20VTX2	00310490865						
400mm x 75mm x 127mm			3TGP60-G20VSPF	00310404597				
400mm x 100mm x 127mm	5NQX60-G20VTX2	00310490916	3TGP60-G20VSPF	00310404598				
400mm x 150mm x 127mm	5NQX60-G20VTX2	00310490917						
450mm x 50mm x 127mm			3TGP80/3-G12VS3G	00310448499				
450mm x 60mm x 127mm	5NQX60-G20VTX2	00310490918						
450mm x 100mm x 127mm	5NQX60-G20VTX2	00310490921	3TGP80/3-G12VS3G	00310448498				
450mm x 150mm x 127mm	5NQX60-G20VTX2	00310490919	3TGP80/3-G12VS3G	00310448497				

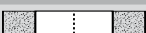
TIER:	BEST		
TRADENAME:	<b>NORTON SEEDED GEL: TG, 5TG, 5SG</b>		
ABRASIVE:	Ceramic Alumina Unfinished Blank Stock		
SIZE (D x T x RIM)	PLATE #	SPEC.	BLANK PART #
<b>Type O2 Plate-Mounted Cylinder</b> 			
3.000 x 3.000 x .600	A311220	5SG80-JVS	00310485211
3.350 x 3.000 x .650	A311220	5SG80-JVS	00310485212
3.750 x 3.000 x .650	A311220	5SG80-JVS	00310485213
4.100 x 3.000 x .700	A311220	5SG80-JVS	00310485214
5.200 x 3.500 x .800	A311250	5SG80-JVS	00310485215
5.700 x 3.500 x .800	A311250	5SG80-JVS	00310485226
7.000 x 3.500 x 1.050	A311251	5SG80-JVS	00310485227
8.400 x 3.500 x 1.050	A311384	5SG80-JVS	00310485228
		TG280-H12V-X575	00310485229
8.346 x 3.500 x 1.043	A311384	5TG80-3-J8VH	00310480245

Gear blank stock alteration orders must include complete blueprint information.

Please ask your Norton representative for appropriate blueprint worksheet to fill in:

- Worm wheel blueprint worksheet: ME161508
- Single rib wheel blueprint worksheet: ME161178



# ID, Race and Superfinishing Wheels and Sticks



The most extensive line of Pressed-To-Size ID and Race wheels to choose from to maximize performance and cost savings.

In addition to VFL wheels, VS3L-bonded wheels are also available. VS3L is the Vitrium3 high-strength, cool-cutting bond with improved cutting efficiency, productivity, and wheel life. VFL and VS3L wheels are the fastest way to get Make-to-Order Norton ID and Race Grinding wheels. Norton VFL and VS3L wheels are available in both ceramic abrasives and conventional aluminum oxide abrasives in diameters up to 5".

Additional dimensions and grinding faces are available as made-to-order products with 4-week lead-times.

**Wheel Types:** Type 01 and 05  
**Abrasive Types:** Ceramic Alumina, Aluminum Oxide

## ID and Race Wheels

### ID and Race Wheel FastTrack Availability

<b>Type 01 Straight</b>	
Diameter: 0.172" thru 4.532"	Maximum thickness: 3.75"
<b>Type 05 Recessed One Side</b>	
Diameter: 0.407" thru 5"	Maximum thickness: 3.10"

For more program details, ask your Norton sales representative to review the FirstLine VFL & VS3L ID and Race Wheels Brochure #6981 with you.

### VFL Availability

ABRASIVE	25A, 32A, 38A, 48A, 53A, 57A, 86A	5TG*	1SG, 3SG, 5SG	32AA	NQ, 1NQ, 3NQ, 5NQ, 1NQP, 3NQP, 5NQP, 1NQM, 3NQM, 5NQM
GRIT	54 - 120	80/1, 120/1	54-120	54-80	54-150
GRADE	J - P	I - M	I - N	I - M	I - N
STRUCTURE	6 (Not Shown)				
BOND	VFL				
WHEEL TYPES	01, 05				
SHAPES	Special faces not available				
SPEED	8,500 SFPM***				
TREAT 22	Not Available				

\* 5TG is available in /1 combination, only  
 \*\*Speeds up to 12,500 SFPM by request and Safety approval

### VS3L Availability

ABRASIVE	25A, 32A, 38A, 55A, 86A	5TG*	1SG, 3SG, 5SG	NQ, 1NQ, 3NQ, 5NQ, 1NQP, 3NQP, 5NQP, 1NQM, 3NQM, 5NQM
GRIT	54-120	80/1, 120/1	54-120	54-150
GRADE	H - P	I - K	I - N	I - N
STRUCTURE	8, 10	8	8, 10	8, 10
BOND	VS3L			
WHEEL TYPES	01, 05			
SHAPES	Special faces not available			
SPEED	8,500 SFPM***			
TREAT 22	Not Available			

\* 5TG is available in /1 combination, only  
 \*\*Speeds up to 12,500 SFPM by request and Safety approval

### Dimensional Tolerances

IF DIAMETER IS:	DIAMETER	THICKNESS	HOLE
0.532" and less	+/- .003"	+ .004" - .000	+ .001" + .006"
> 0.532" - 2.907"	+/- .005"	+/- .005"	+ .001" + .006"
> 2.907" - 4.407"	+/- .015"	+/- .015"	+ .001" + .006"



# ID, Race and Superfinishing Wheels and Sticks

## Blank Stock FastTrack Made-to-Order Microabrasive Superfinishing Sticks



Superfinishing blank stock encompasses a wide range of different specifications. These blanks can be finished to your dimensional requirements within two weeks from the date that the order is received at Norton Customer Service. Small lots, for test purposes, can be express shipped.

APPLICATIONS	ABRASIVE TYPE – BOND	GRIT RANGE	TREATMENT TYPE
Superfinishing / Finishing	NLA – V	240 – 1200	Sulfur, Wax
	NMVC – VCA		
	NSA – V		
Honing	SG – VS	54 – 220	
	SGG – VS1		

## Rubber Finishing Sticks

These sticks are used for manual or mechanical honing on machines where they are mounted in holders or fixtures. Intended for use where precision dimensional limits and grade controls are required, such as die polishing.



SIZE (T x W x L)	STD. PKG./CASE	SPEC.	PART #
<b>Rubber Finishing Sticks</b>			
1/2 x 1/2 x 6	5/20	57A120-B2RR	614636 <b>10608</b>
1/2 x 1 x 6	5/20	57A120-B2RR	614636 <b>10609</b>

our dressing tools  
**MAKE THE  
PERFECT POINT**

The Norton Winter full line of expertly-crafted stationary and rotary dressing tools - whether stock or custom-engineered - delivers your every application need. And, our expert resetting and relapping services renew used tools to reduce your "cost per dress."

# Diamond Stationary Dressing Tools



Our Norton Winter offering is the industry's most comprehensive line of stock and made-to-order products to true (restore the wheel's profile) and dress (opening – to remove stock – or closing to finish) the face of the wheel. In addition to these catalog stock stationary tools, Norton Winter manufactures a full line of custom stationary tools, rotary diamond dressers and truing/dressing devices to meet all your specific application needs.

**Applications:**

Truing and dressing conventional and superabrasive wheels, straight, step, radius and form dressing

**Tool Types:**

Stationary: Single Point, Toolroom, Multi-Point, Blade, Form, and Cluster Tools, and Truing Devices

Rotary: Reverse Plated and Infiltrated Form Plunge Diamond Rolls, Diamond CNC Traversing Discs, and Dressing Spindles

## Determining the Best Value

Remember that diamonds are a rare commodity—the larger the stone and the better the quality, the higher the initial cost. The key to successful diamond tool productivity and use is based on the "cost per dress." Normally, higher quality diamonds and a proactive resetting program will result in the lowest "cost per dress."

In those situations where a resetting program is not feasible or low initial cost is the primary purchasing consideration, Norton Winter offers a complete line of non-resettable tools.

## Resetting Your Used Diamond Tools

Resetting – Minimizing Your Cost

**Buying a higher quality diamond is your best value, especially if you participate in a proactive resetting program. Although initial cost may be higher, the payback comes through several factors:**

- Diamond durability, providing longer tool life
- Tighter form tolerances
- Consistent finish rates
- Resetting the diamond lowers the overall tooling cost

Used properly, the overall cost of a higher quality, resettable diamond will compare favorably with that of an inexpensive, non-resettable diamond. Initially, the best diamond point is selected for use. When returned, the next best diamond point is selected for resetting, and so on.

**To ensure you get the best value for your diamond:**

- Rotate the diamond tool ¼ turn periodically to maintain a sharp point
- Use proper flow of coolant to protect the diamond from heat which can create fracturing of the diamond
- Excessive wear on the diamond point may impact the ability to reset the diamond. The widest point of the diamond is referred to as the girth. The diamond girth is buried in a powder metal matrix. Using a diamond into the girth zone might impact the ability to reset other diamond points

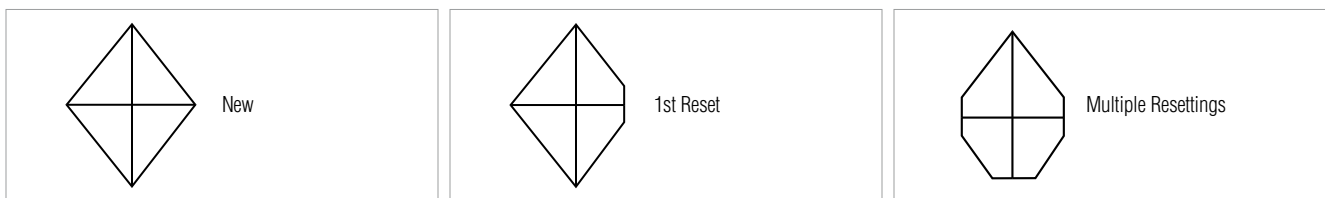

## TECH TIP

### Selecting the Correct Diamond Tool

To determine the type of dressing tool to use, it is best to think about the desired shape of the wheel face. Finished wheel face shapes are generally categorized into six types, as illustrated below.

### Typical Wheel Forms Dressed by Stationary Diamond Tools

Look for the applicable wheel forms beside each product type to help you choose the correct product for your application.

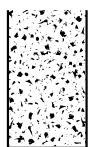

Straight



Tapered



Convex

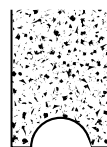

Concave

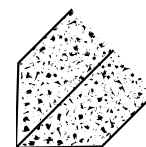

Angled

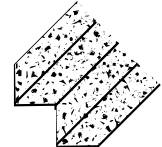

Multi-Angled



### Single Point Tools

Our Norton Winter line of single point tools is used in straight and simple form dressing applications. It includes: resettable and non-resettable products, tools for all abrasive types (conventional and advanced ceramic grains) and the technology-leading "Indexable" tool design.

#### Wheel Forms Dressed by These Tools



STRAIGHT



TAPERED



CONVEX

## SPEC CHECK

### Selection Guide

#### Stock Tools for Ceramic Abrasive Wheels

**SG/Ceramic** Engineered for use on ceramic (SG, NQ, Targa, etc.) wheels but may also provide significant benefits when used on conventional abrasive products. These tools are furnished with top quality specially selected diamonds.

**BCSG/Ceramic** Economical alternative to an "SG" tool. Best choice when a disposable tool is preferred.

#### Stock Tools for Conventional Abrasive Wheels

**NS** Engineered for use on conventional abrasives. These high quality, value-priced tools can be used for a variety of dressing applications.

**BC** Economical alternative to an "NS" tool. Best choice when a disposable tool is preferred.

#### Selecting the Correct Single Point Tool:

- Identify the wheel abrasive type: aluminum oxide, silicon carbide, or ceramic
- Determine the wheel diameter – to select the optimum carat weight
- Determine the tool holder size – to select appropriate shank diameter

#### Examples of Single Point Tool Selection

Conventional Wheel Spec:	32A46-IVBE 7" x 1/2" x 1-1/4"
	Machine has a 7/16" tool holder
Tool Selections:	Resettable: NS2M7 or NSUD2 (Indexable)
	Non-Resettable: BC2M7 or BCUD2 (Indexable)
Ceramic Wheel Spec:	5SG60-JVS or 5NQ60-IVS 10" x 1" x 3"
	Machine has a 3/8" tool holder
Tool Selections:	Resettable: SG3M6
	Non-Resettable: BCSG3M6

## TECH TIP

- Rigidly mount single point tools at a 10° - 15° angle to the wheel centerline with a line drawn through the center of the wheel, pointing in the direction of wheel travel
- Point of contact should be slightly below centerline of wheel as shown
- Use coolant whenever possible
- Normal infeed is .001" per pass
- Lead selections range from .002" – .010" per wheel revolution
- Rotate the tool 1/4 turn periodically to maintain a sharp point

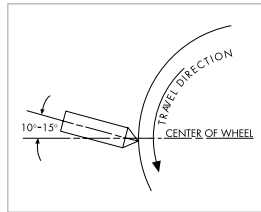

To optimize applications using ceramic abrasives and/or tools, normal dressing parameters must change. Reduce infeed by 25%. Significant reductions in the amount of infeed and frequency of dress will result in substantially lower cost per part ground.

### Single Point Dress Traverse Rate

Select a Lead Value based on desired Surface Finish and run the formula below.

Finish	Lead Value (Per Wheel Revolutions)
For Coarse Finish (approx. 64 RMS)	.008" to .010"
For Medium Finish (approx. 32 RMS)	.005" to .009"
For Fine Finish (approx. 16 RMS)	.002" to .004"

Lead Value x Wheel Speed (RPM) = Traverse Rate in Inches/Minute

- Slower traverse rates result in a closed wheel face and lower surface finish readings on the workpiece.
- Faster traverse rates result in an open wheel face that produces greater stock removal and a rougher workpiece finish.



It is the user's responsibility to refer to and comply with ANSI B7.1



Single Point Tools for Truing/Dressing Ceramic Abrasives



SINGLE POINT TOOLS FOR SG/CERAMIC

- Specially selected broad-shaped, diamond withstands the increased grinding pressures of ceramic abrasives
- Each diamond is hand selected for stone shape, quality and structural integrity for consistent tool performance
- Multi-purpose - can accommodate most straight dressing and simple form dressing applications; stands up to the sharpness of ceramic abrasives (SG, Quantum, Targa, etc.) but can also be used to dress conventional abrasives

Resettable Single Point Tools for SG/Ceramic

- High quality diamond and a proactive resetting program will result in the lowest dressing cost per part for ceramic abrasives

Non-Resettable Single Point Tools for BCSG/Ceramic

- The best selection for ceramic abrasives when a resetting program is not feasible or low initial cost is the primary purchasing consideration

WHEEL DIAMETER	TOOL CARAT WEIGHT	TOOL DIAMETER	TOOL LENGTH	TIER: BEST		GOOD	
				PRODUCT #	3 SETTABLE PTS (2 RESETS) PART #	PRODUCT #	NON-RESETTABLE PART #
<b>Stock Single Point Tools for Truing/Dressing Ceramic Abrasives</b>							
Up to 7"	1/4 (.25)	3/8"	2"	SG2M6	662601 <b>95365</b>	BCSG2M6	662601 <b>57007</b>
		7/16"	2"	SG2M7	662601 <b>95366</b>	BCSG2M7	662601 <b>56905</b>
8" to 10"	1/3 (.33)	3/8"	2"	SG3M6		BCSG3M6	662601 <b>57008</b>
		7/16"	2"	SG3M7	662601 <b>95368</b>	BCSG3M7	662601 <b>56906</b>
11" to 14"	1/2 (.50)	3/8"	2"	SG5M6	662601 <b>95369</b>	BCSG5M6	662601 <b>57009</b>
		7/16"	2"	SG5M7	662601 <b>95370</b>	CSG5M7	662601 <b>56907</b>
15" to 20"	3/4 (.75)	7/16"	2"	SG7M7	662601 <b>95372</b>	BCSG7M	662601 <b>56908</b>
21"+	1 (1.00)	7/16"	2"			BCSG10M7	662601 <b>57010</b>

Standard Package = 1 tool

Wheel Forms Dressed by These Tools

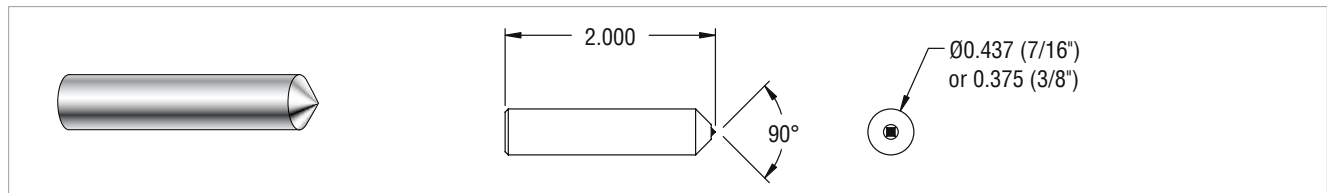
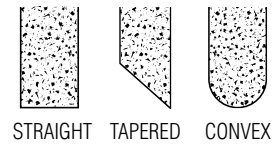

**TECH TIP**

Stock Single Point Tool Marking System

Diamond Quality	Diamond Size	Shank Design	Shank Diameter
SG/Ceramic	1 = 1/5 (.20) carat	M	6 = 3/8"
BCSG/Ceramic	2 = 1/4 (.25) carat	J	7 = 7/16"
NS	3 = 1/3 (.33) carat		
BC	5 = 1/2 (.50) carat		
	7 = 3/4 (.75) carat		
	10 = 1 carat		

Example: **NS 2 M 6**

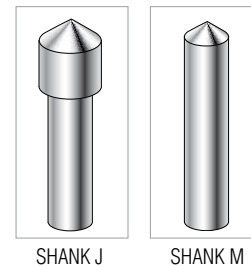

Single Point Tools for Truing/Dressing Conventional Abrasives



SINGLE POINT TOOLS FOR CONVENTIONAL ABRASIVES

- Consistent diamond structure and shape for repeatable dressing performance on conventional abrasives
- Well defined, sharp, durable diamond point offers maximum cost effectiveness
- Steeper 60 degree angle head design allows for greater machine and part clearance to produce forms with tighter tolerances

Resettable NS (Norton Standard) Single Point Tools

- Selection of the correct tool and a proactive resetting program will usually result in the lowest dressing cost per part on conventional abrasives with these value priced, high quality diamonds

Non-resettable BC Single Point Tools

- The best selection for conventional abrasives when a resetting program is not feasible or low initial cost is the primary purchasing consideration

		TIER: <b>BETTER</b>			GOOD		
		TRADENAME: <b>NS (NORTON STANDARD)</b>			<b>BC</b>		
WHEEL DIAMETER	TOOL CARAT WEIGHT	TOOL DIAMETER	PRODUCT #	2 SETTABLE PTS (1 RESET) PART #	PRODUCT #	NON RESETTABLE PART #	
<b>Stock Single Point Tools for Truing/Dressing Conventional Abrasives</b>							
Internal Wheel	1/5 (.20)	3/8"			BC1M6	662601 <b>95021</b>	
		7/16"			BC1M7	662601 <b>95022</b>	
Up to 7"	1/4 (.25)	3/8"	NS2M6	662601 <b>95116</b>	BC2M6	662601 <b>95000</b>	
		7/16"	NS2M7	662601 <b>95117</b>	BC2M7	662601 <b>95001</b>	
8" to 10"	1/3 (.33)	3/8"	NS3M6	662601 <b>95121</b>	BC3M6	662601 <b>95002</b>	
		7/16"	NS3M7	662601 <b>95122</b>	BC3M7	662601 <b>95003</b>	
11" to 14"	1/2 (.50)	3/8"	NS5M6	662601 <b>95126</b>	BC5M6	662601 <b>95004</b>	
		7/16"	NS5M7	662601 <b>95127</b>	BC5M7	662601 <b>95005</b>	
15" to 20"	3/4 (.75)	3/8"			BC7M6	662601 <b>95006</b>	
		7/16"	NS7M7	662601 <b>95132</b>	BC7M7	662601 <b>95007</b>	
		7/16"	NS7J7*	662601 <b>95130</b>			
21" +	1 (1.00)	3/8"	NS10M6	662601 <b>95136</b>	BC10M6	662601 <b>95008</b>	
		7/16"	NS10M7	662601 <b>95137</b>	BC10M7	662601 <b>95009</b>	
		7/16"	NS10J7 *	662601 <b>95135</b>			

\* J-shank tools are available in 7/16" diameter with 5/8" head. Standard Package = one tool

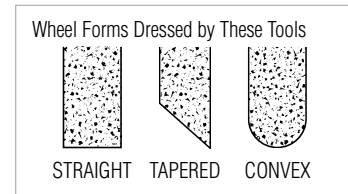
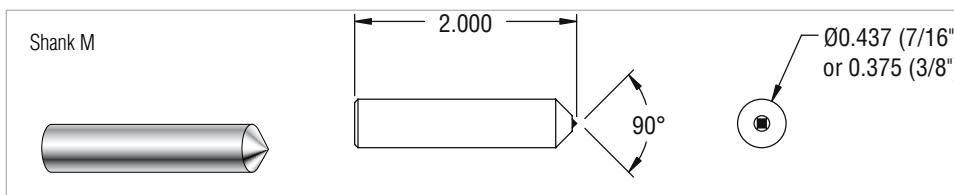
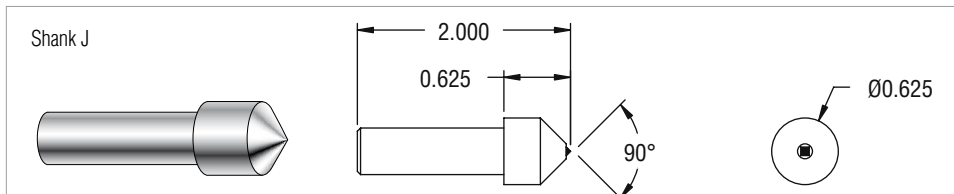

Refer to our Diamond and cBN Superabrasive Standard Product Catalog #8068 sections on [www.nortonabrasives.com](http://www.nortonabrasives.com) or your Norton representative for more in-depth information on all Norton Winter superabrasive stock and made-to-order products.

## Indexable Single Point Tools

Indexable tools are specifically designed to alleviate any misalignment issues and are the tools of choice for CNC grinders. They feature a two-part construction with the head and shank as separate pieces. After the initial installation, operators simply turn the indexable head with a wrench, while the tool shank remains secure (and aligned) in the tool holder.



## INDEXABLE SINGLE POINT TOOLS

- These indexable tools are easily turned without having to remove the tool from the holder, making it easier to turn than conventional tools and increasing frequency of beneficial tool turning
- U-Dex-It and Mini-Dex tools have a 60° included angle head design providing additional form versatility through better machine and part clearance
- Offers an excellent choice for regulating wheels

### Indexable Single Point Tools for Truing/Dressing Conventional Abrasives

#### Resettable NS (Norton Standard) Indexable Single Point Tools

- Selection of the correct tool and a proactive resetting program will usually result in the lowest dressing cost per part on conventional abrasives with these value priced, high quality diamonds
- Ideal for centerless grinders; using standard 5/8" wrench, the head can be turned through the hole in the side of the wheel guard without removing the guard

#### Resettable NS (Norton Standard) Mini-Dex Indexable Single Point Tools

- Selection of the correct tool and a proactive resetting program will usually result in the lowest dressing cost per part on conventional abrasives with these value priced, high quality diamonds
- Use a standard 7/16" wrench to turn; designed for internal, bearing race, and twist drill flute machines

#### Non-Resettable Indexable Single Point Tools

- The best selection for conventional abrasives when a resetting program is not feasible or low initial cost is the primary purchasing consideration
- Ideal for centerless grinders; using standard 5/8" wrench, the head can be turned through the hole in the side of the wheel guard without removing the guard

WHEEL DIAMETER	TOOL CARAT WEIGHT	TOOL SIZE	TIER: BETTER		GOOD	
			PRODUCT #	2 SETTABLE PTS (1 RESET) PART #	PRODUCT #	NON-RESETTING PART #
<b>Stock Indexable Single Point Tools for Truing/Dressing Conventional Abrasives</b>						
Up to 7"	1/4 (.25)	7/16" x 1-7/16" with 5/8" head			BCUD2	662601 <b>95023</b>
		1/4" x 1-3/16" with 7/16" head	NSMD2	662601 <b>95171</b>		
8" to 10"	1/3 (.33)	7/16" x 1-7/16" with 5/8" head	NSUD3	662601 <b>95162</b>		
11" to 14"	1/2 (.50)	7/16" x 1-7/16" with 5/8" head	NSUD5	662601 <b>95163</b>	BCUD5	662601 <b>95025</b>
15" to 20"	3/4 (.75)	7/16" x 1-7/16" with 5/8" head	NSUD7	662601 <b>95164</b>		

Standard Package = one tool

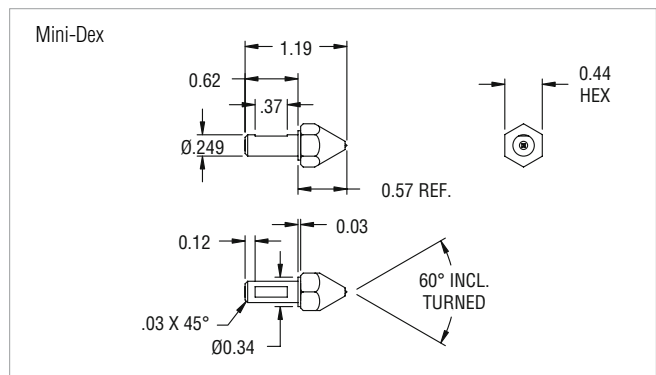
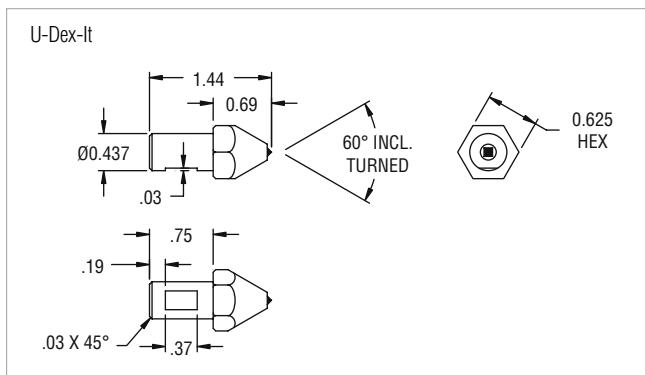

**Indexable Single Point Tools *continued***

**Indexable Single Point Tools for Truing / Dressing Ceramic Abrasives**

Non-Resettable Ceramic Indexable Single Point Tools

- U-Dex-It BCSG tool contain specially selected diamonds to withstand increased ceramic (SG, Quantum, Targa, etc.) grinding pressures
- Ideal for centerless grinders; using standard 5/8" wrench, the head can be turned through the hole in the side of the wheel guard without removing the guard
- The best selection when a resetting program is not feasible or low initial cost is the primary purchasing consideration

			TIER: <b>GOOD</b>	
WHEEL DIAMETER	TOOL CARAT WEIGHT	TOOL SIZE	PRODUCT #	NON-RESETTABLE PART #
<b>Stock Indexable Single Point Tools for Truing/Dressing Ceramic Abrasives</b>				
11" to 14"	1/2 (.50)	7/16" x 1-7/16" with 5/8" head	BCSGUD5	66260159894
<i>Standard Package = one tool</i>				

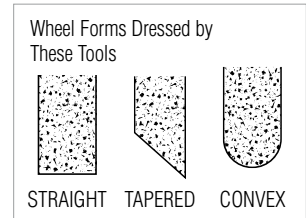
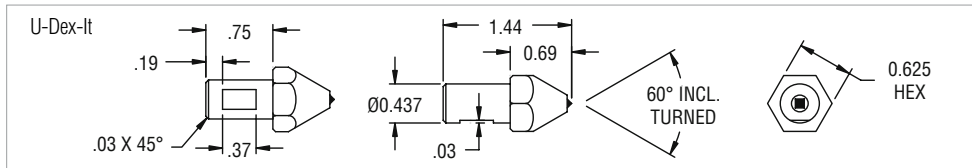

Refer to our Diamond and cBN Superabrasive Standard Product Catalog #8068 sections on [www.nortonabrasives.com](http://www.nortonabrasives.com) or your Norton representative for more in-depth information on all Norton Winter superabrasive stock and made-to-order products.

### Internal Grinding Tools



Resettable Tools For Internal Grinding

- Q style shank is used on a Heald internal grinder (resettable)

Wheel Forms Dressed by These Tools

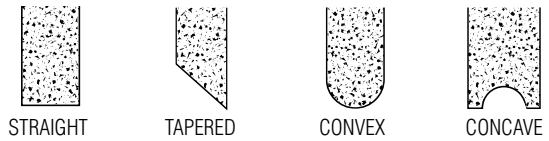

TIER: BEST					
MACHINE TYPE	CARAT WEIGHT	SHANK DIAMETER	TOOL LENGTH	PRODUCT #	2 SETTABLE PTS (1 RESET) PART #
<b>Stock Internal Grinding Tools</b>					
Heald	1/5 (.20)	7/16"	1"	NI21Q7	662601 <b>95180</b>
Standard Package = 1 Tool					

Shank Q for Heald Machine

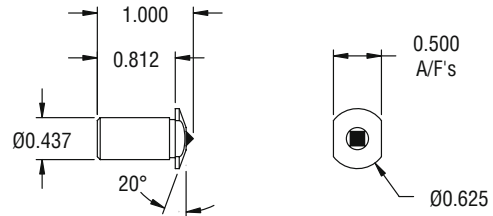

### Thread Grinding Tools



Thread Grinding Tools For SG / Ceramic Abrasives

- These wheels are used on J & L and Excello thread grinding machines to accurately dress the grinding wheels that form the desired thread configuration (non-resettable)

TIER: BEST						
MACHINE TYPE	SHANK DIAMETER	TOOL LENGTH	INCLUDED ANGLE	MAX. RADIUS ON POINT	PRODUCT #	NON-RESETTABLE PART #
<b>Stock Thread Grinding Tools</b>						
J & L	1/4"	1"			38RL4*	662601 <b>95100</b>
J & L	1/4"	1"	80°	.010"	NT1L4	662601 <b>95187</b>
EXCELLO	3/8"	1-5/8"	60°	.010"	NT106	662601 <b>95190</b>

\* 38RL4 is a multi-point (grit) 30 - 40 mesh tool  
Standard Package = 1 Tool

Wheel Forms Dressed by These Tools

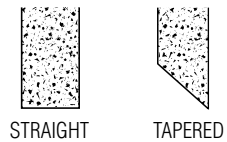

NT1L4 for Jones & Lamson Machine

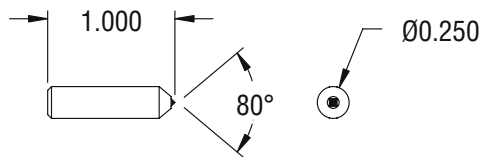

NT106 for Excello Machine

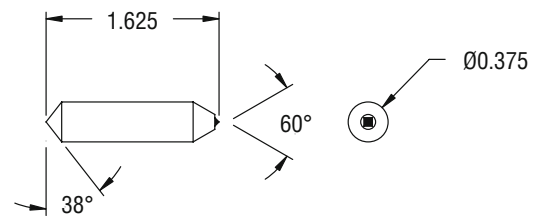

38RL4 for Jones & Lamson Machine

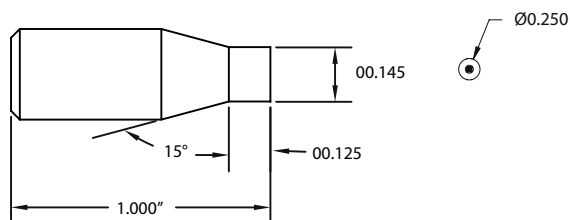

Refer to our Diamond and cBN Superabrasive Standard Product Catalog #8068 sections on [www.nortonabrasives.com](http://www.nortonabrasives.com) or your Norton representative for more in-depth information on all Norton Winter superabrasive stock and made-to-order products.



### Toolroom Tools

Norton Winter Toolroom Dressing Tools are primarily used on surface grinders to form the grinding wheel to an exact concave or convex radius. Although some tools are designed for use on a specific machine, many radius tools can be used on any grinder having the correct set-up.

Used generally on 8" diameter and smaller vitrified toolroom wheels, our Norton Winter offering includes phono-point, conventional radius, and full ball radius tools.

#### Wheel Forms Dressed by These Tools



STRAIGHT



CONCAVE



CONVEX

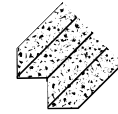

MULTI-ANGLED

### Phono-Point Tools

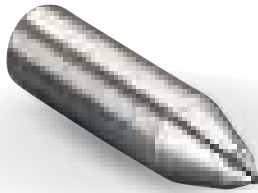

#### Non-Resettable Phono-Point Tools

- For general toolroom concave and convex dressing on small diameter grinding wheels

INCLUDED ANGLE	SHANK DIAMETER	TOOL LENGTH	TIER: BETTER		GOOD	
			PRODUCT #	NON-RESETTABLE PART #	PRODUCT #	NON-RESETTABLE PART #
<b>Stock Phono-Point Tools</b>						
60°	1/8"	1"	NP1M2	662601 <b>95225</b>	BCPP-60	662601 <b>95017</b>
	3/16"	1"	NP1M3	662601 <b>95226</b>		
	1/4"	1"	NP1M4	662601 <b>95227</b>		
75°	1/8"	1"	NP2M2	662601 <b>95228</b>	BCPP-75	662601 <b>95018</b>
	1/4"	1"	NP2M4	662601 <b>95230</b>		
90°	1/8"	1"	NP3M2	662601 <b>95231</b>	BCPP-90	662601 <b>95019</b>
	3/16"	1"	NP3M3	662601 <b>95232</b>		
	1/4"	1"	NP3M4	662601 <b>95233</b>		

Standard Package = one tool

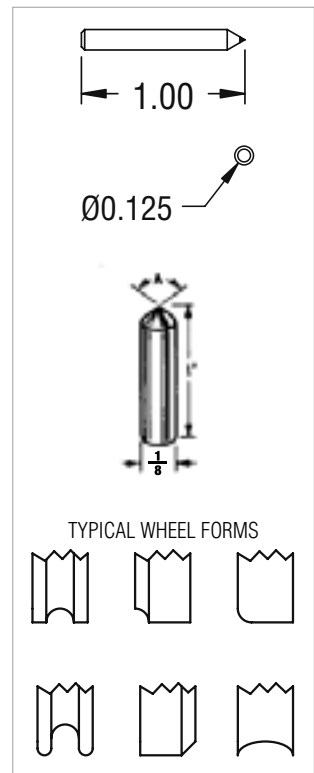

Wheel Forms Dressed by These Tools



CONVEX

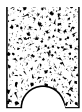

CONCAVE

### SPEC CHECK

#### Phono-Point Tool Marking System

Diamond Type	Included Angle On Diamond	Shank Style	Shank Diameter
NP	1 = 60°	M	2 = 1/8"
BCPP	2 = 75°		3 = 3/16"
	3 = 90°		4 = 1/4"

Example: **NP 1 M 3**

### TECH TIP

#### How to Use Toolroom Tools

- We recommend dressing with coolant. However, if dressing totally dry, allow three to five seconds between passes for diamond to cool.
- Use extremely light cuts from .0002" to .001" maximum.
- Rotate tool if the application and set-up allow.
- Custom Full Ball Radius Tools should be returned for relap after minimum wear.

## Radius Tools

### Concave Radius Tools

- This line offers a specially-shaped single point diamond, designed for forming concave radii on small diameter grinding wheels; not resettable.

### Convex Radius Tools

- This line offers a specially-shaped single point diamond, designed for forming convex radii on small diameter grinding wheels; not resettable.

### Half-Circle Concave Radius Tools (Available as Non-stock Only)

- This line offers a specially-shaped diamond set in the side of the shank for forming half-circle radii on small diameter grinding wheels.
- The tool is rotated to form the radius. Commonly called a "rat tail dresser"; not resettable.

RADIUS SIZE TO BE DRESSED	SHANK DIAMETER	TOOL LENGTH	TIER: <b>BEST</b>		<b>GOOD</b>	
			PRODUCT #	NON-RESETTABLE PART #	PRODUCT #	NON-RESETTABLE PART #
<b>Stock Concave Radius Tools</b>						
.010" to .015"	3/8"	2"	NR1P6	662601 <b>95210</b>		
.016" to .020"	3/8"	2"	NR2P6	662601 <b>95211</b>		
.021" to .032"	3/8"	2"	NR3P6	662601 <b>95212</b>		
.033" to .062"	3/8"	2"	NR4P6	662601 <b>95213</b>	BCRD	662601 <b>95016</b>
.063" to .125"	3/8"	2"	NR5P6	662601 <b>95214</b>	BCRD	662601 <b>95016</b>
.126" to .250"	3/8"	2"	NR6P6	662601 <b>95215</b>	BCRD	662601 <b>95016</b>
<b>Stock Convex Radius Tools</b>						
.020" to .125"	3/8"	2"	NR2M6	662601 <b>95216</b>		
.126" to .250"	3/8"	2"	NR12M6	662601 <b>95217</b>		

Standard Package = one tool

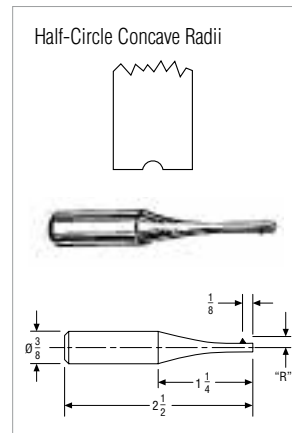
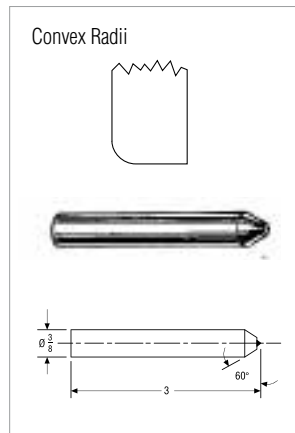
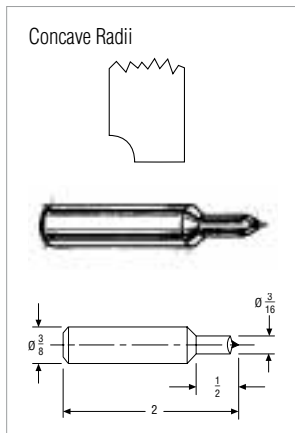

Full-Ball Radius Tools for precision plunge form dressing of concave radii in the center of a grinding wheel are available made to your custom requirements. Ask your Norton representative for details.

Refer to our Diamond and cBN Superabrasive Standard Product Catalog #8068 sections on [www.nortonabrasives.com](http://www.nortonabrasives.com) or your Norton representative for more in-depth information on all Norton Winter superabrasive stock and made-to-order products.



### Multi-Point (Grit) Tools

Since Norton Winter conventional and high-performance Multi-Point tools never need turning or resetting, they are the most economical way to accomplish a variety of straight, tapered, and step dressing operations on all sizes of cylindrical, centerless, surface, and toolroom grinding wheel applications.

#### Wheel Forms Dressed by These Tools



STRAIGHT



TAPERED

## SPEC CHECK

### Selection Guide

- Identify the wheel abrasive type: ceramic (SG, Quantum, Targa), aluminum oxide, or silicon carbide
- Determine the wheel diameter and grit size
- Determine the tool's approach angle to the centerline of the wheel
- Identify the tool holder diameter
- Use 1E shape for angular wheel slide, cylindrical grinding and for shoulder or step truing

### Examples of Multi-Point Tool Selection

Conventional Wheel Spec:	32A46-IVBE 7" x 1/2" x 1-1/4" Machine has a 3/8" tool holder
Tool Selection:	1R6J6
Ceramic Wheel Spec:	5SG60-JVS or 5NQ60-IVS 10" x 1" x 3" Machine has a 7/16" tool holder
Tool Selections:	SG1R6J7

## TECH TIP

### Multi-Point Tools – Straight Face Dressing and Truing

- Most multi-point tools are used for straight face dressing
- Tool should have full face contact with the wheel
- With new tool, 3–5 passes at .005" per pass should be taken to expose diamonds
- Infeed per pass .001" – .002"
- Use coolant whenever possible
- Use appropriate lead (and traverse rate)
- Contact your Norton representative for proper tool selection for Targa wheels

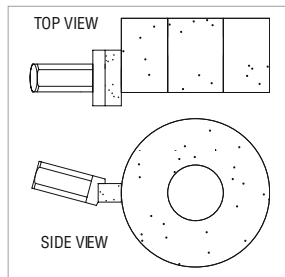

### Multi-Point Dress Traverse Rate

Select a Lead Value based on desired Surface Finish and run the formula below.

FINISH	LEAD VALUE (PER WHEEL REVOLUTIONS)
For Coarse Finish (approx. 64 RMS)	.023" to .030" (.58mm – .76mm)
For Medium Finish (approx. 32 RMS)	.013" to .022" (.33mm – .57mm)
For Fine Finish (approx. 16 RMS)	.006" to .012" (.15mm – .33mm)

*Lead Value x Wheel Speed (RPM) = Traverse Rate in Inches/Minute*

- Slower traverse rates result in a closed wheel face that produces less stock removal and improved workpiece finish.
- Faster traverse rates result in an open wheel face that produces greater stock removal and a rougher workpiece finish.



It is the user's responsibility to refer to and comply with ANSI B7.1

## TECH TIP

### Optimizing SG Multi-Point Tool Performance

- To optimize applications using ceramic abrasives/tools, normal dressing parameters must change. Significant reductions in the amount of infeed and frequency of dress will result in significantly lower cost per part ground.
- While all SG/Ceramic tools have been designed to improve the efficiency of ceramic grinding applications, they can also offer significant benefits in many applications using conventional abrasives.
- When first using a SG/Ceramic tool, make 3 to 5 passes at .005" infeed to ensure full face contact between the dressing tool and wheel face.
- Reduce normal dressing infeed by half. Do not exceed infeed of .002" per pass.
- The lead selection should be between .006"–.030" per wheel revolution. Faster traverse with a SG/Ceramic tool generally provides an open wheel face that can maximize productivity of the ceramic abrasive.



**TECH TIP**

Multi-Point Tool Diamond Section Specifications

SHAPE	WIDTH	LENGTH	DEPTH	TOOL APPROACH ANGLE TO WHEEL	FOR WHEEL DIAMETER
1A	1/4"	3/4"	5/16"	0°	Over 20"
2A	1/4"	1/2"	3/8"	0°	15" – 20"
3A	5/32"	3/8"	1/4"	0°	Over 20"
1E	5/32"	3/8"	5/16"	–	
2E	1/4"	1/2"	1/2"	–	20" x 2" and up
1R	1/4" Round		1/4"	0°	Up to 10"
2R	3/8" Round		3/8"	0°	11" – 14"

Multi-Point Tool Marking System

Diamond Shape	Tool Diamond Size	To Dress Grinding Wheels With Grit Size Of:	Shank Design	Shank Diameter
1A	4	= 46 grit	See the following pages for shank configurations	6 = 3/8"
2A	6	= 54 - 100 grit		7 = 7/16"
3A	8	= 120 - 150 grit		8 = 1/2"
1E	12	= 150+ grit		
2E	14	= Special Applications		
1R				
2R				

Example: **1A 6 A 7**

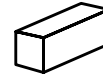

Shape A is used primarily for straight face dressing.



Shape E (double angle top face) [is used for standard N-Face wheels, angular wheels, face and side truing of cylindrical wheels, and in step dressing.



Shape R is used for straight face dressing where the tool holder is perpendicular to the wheel face (no drag angle), and on thread grinding machines.

Multi-Point Tools for Straight Dressing

SG MULTI-POINT TOOL SHAPE AND SHANK AVAILABILITY

SHAPE SG1A SHANK A	SHAPE SG1A SHANK C	SHAPE SG2A SHANK D
SHAPE SG2A SHANK E	SHAPE SG1R SHANK J	SHAPE SG2R SHANK K

CONVENTIONAL TOOLROOM MULTI-POINT TOOL SHAPE AND SHANK AVAILABILITY

SHAPE 1A BC-60	SHAPE 1A BC-61	SHAPE 2A BC-62
SHAPE 2A BC-63	SHAPE 1R BC-64	SHAPE 1R BC-65

CONVENTIONAL ABRASIVE MULTI-POINT TOOL SHAPE AND SHANK AVAILABILITY

SHAPE 1A SHANK A	SHAPE 1A SHANK B	SHAPE 1A SHANK C	SHAPE 2A SHANK D	SHAPE 2A SHANK E	SHAPE 3A SHANK F
SHAPE 3A SHANK G	SHAPE 1E SHANK F	SHAPE 1R SHANK J	SHAPE 2R SHANK K	SHAPE 3R SHANK L	

Shapes 3A (F and G Shanks) are used for form, shape, and step truing. Shape 1E is used for angle dressing



## MULTI-POINT TOOLS

- Uniformly distributed diamonds in a tough, durable matrix for consistent performance throughout tool life
- Fresh, multiple diamond points exposed in truing operation; no turning or resetting required for faster, more consistent straight face dressing and longer tool life than single point tools
- Overall diamond weight exceeds equivalent single point tool making this the most economical way to dress straight and tapered forms

### Multi-Point Tools for Truing and Straight Dressing

Multi-Point Tools For SG/Ceramic Abrasives

- Designed specifically for use on ceramic (SG, Quantum, Targa, etc.) abrasives, SG tools contain a higher diamond concentration to withstand the increased grinding pressures generated by the ceramic abrasives
- These tools have improved life and dress quality; they can also offer significant benefits in many applications when used on conventional abrasives

Standard Multi-Point Tools

- The ideal selection for use on conventional abrasives in high-production applications

BC Multi-Point Tools

- General-purpose tools ideal for conventional toolroom applications with a specially selected diamond size for a broad range of dressing applications

WHEEL DIAMETER	WHEEL GRIT SIZE	TOOL APPROACH ANGLE	TOOL DIAMETER	TIER: <b>BEST</b> SG/CERAMIC		TIER: <b>BETTER</b> STANDARD		TIER: <b>GOOD</b> BC	
				PRODUCT #	PART #	PRODUCT #	PART #	PRODUCT #	PART #
<b>Multi-Point Tools for Straight Dressing</b>									
Up to 10"	54 to 100	0°	7/16"			1R6J7	662601 <b>95088</b>	BC64	662601 <b>95014</b>
		0°	3/8"			1R6J6	662601 <b>95085</b>		
11" to 14"	54 to 100	0°	7/16"	SG2R6K7	662601 <b>95378</b>	2R6K7	662601 <b>95096</b>	BC65	662601 <b>95015</b>
15" to 20"	46	15°	7/16"			2A4E7	662601 <b>95048</b>		
		0°	7/16"	SG2A6D7	662601 <b>95375</b>	2A6D7	662601 <b>95046</b>	BC62	662601 <b>95012</b>
	120 to 150	15°	7/16"	SG2A6E7	662601 <b>95376</b>	2A6E7	662601 <b>95049</b>	BC63	662601 <b>95013</b>
		0°	7/16"			2A8D7	662601 <b>95047</b>		
21" +	46	15°	7/16"			2A8E7	662601 <b>95050</b>		
		0°	7/16"			1A4C7	662601 <b>95038</b>		
	54 to 100	0°	7/16"	SG1A6A7	662601 <b>95373</b>	1A6A7	662601 <b>95031</b>	BC61	662601 <b>95011</b>
		15°	7/16"			1A6B7	662601 <b>95035</b>		
	120 to 150	15°	7/16"	SG1A6C7	662601 <b>95374</b>	1A6C7	662601 <b>95039</b>	BC60	662601 <b>95010</b>
		0°	7/16"			1A8C7	662601 <b>95040</b>		



Standard Package = one tool

### Multi-Point Tools for Form, Shape, or Step Dressing Conventional Abrasives

WHEEL DIAMETER	WHEEL GRIT SIZE	TOOL APPROACH ANGLE	TOOL DIAMETER	TIER: <b>BETTER</b>	
				PRODUCT #	PART #
<b>Stock Multi-Point Tools for Form, Shape, and Step Dressing</b>					
All	54 to 100	0°	7/16"	3A6F7	662601 <b>95055</b>
		15°	7/16"	3A6G7	662601 <b>95975</b>

Standard Package = one tool

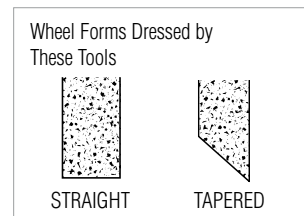

WHEEL DIAMETER	WHEEL GRIT SIZE	TOOL APPROACH ANGLE	TOOL DIAMETER	TIER: <b>BETTER</b>	
				PRODUCT #	PART #
<b>Stock Multi-Point Tools for Angular Dressing Conventional Abrasives</b>					
All	54 to 100	0°	7/16"	1E6F7	662601 <b>95080</b>

Standard Package = one tool

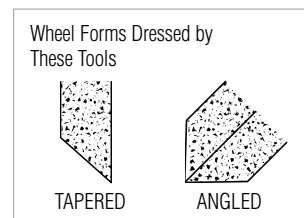



### High Performance Grit Tools

Norton Winter High Performance grit tools are used in the same manner as multi-point tools, but are designed to produce a superior finish. They are used on 120 - 150 grit wheels. The traverse rates are equal to or faster than ordinary tools. Mounted on standard shanks, standard High Performance grit tools have a 3/8" wide by .100" thick diamond impregnated blade with a greater number of sharp points than in ordinary multi-point tools.

Since High Performance grit tools contain a higher concentration of diamond than found in standard multi-point tools, they are well suited for ceramic abrasive applications.

### Typical Machines and Applications

- HP4439: cylindrical machines, grinding thrust walls, bearing diameters and multi-diameter shafts with radii
- HP4511: angular machines plunge grinding multi-diameter shafts and plunge grinding on dual-wheel forms
- HP4595: cylindrical machines grinding main bearing and lobes on camshafts
- HP4596: centerless machines step grinding and machines dual-wheel grinding transmission shafts

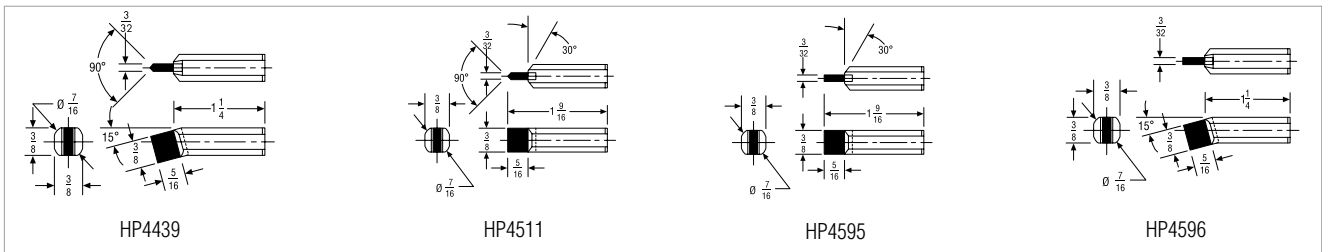

TIER: BEST					
WHEEL DIAMETER	WHEEL GRIT SIZE	SHANK DIAMETER	TOOL LENGTH	PRODUCT #	PART #
<b>Stock High Performance Grit Tools</b>					
Up to 20"	120 to 150	7/16"	1-9/16"	HP4439	662601 <b>95270</b>
Up to 20"	120 to 150	7/16"	1-9/16"	HP4511	662601 <b>95271</b>
Up to 20"	120 to 150	7/16"	1-9/16"	HP4595	662601 <b>95272</b>
Up to 20"	120 to 150	7/16"	1-9/16"	HP4596	662601 <b>95273</b>

Standard Package = one tool

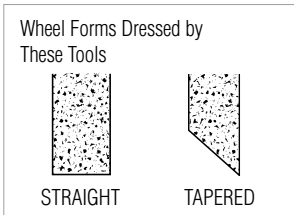

Refer to our Diamond and cBN Superabrasive Standard Product Catalog #8068 sections on [www.nortonabrasives.com](http://www.nortonabrasives.com) or your Norton representative for more in-depth information on all Norton Winter superabrasive stock and made-to-order products.



**Blade Tools**

With the choice of natural and synthetic diamond in three performance/price tiers, blade tools can meet all your angle, step, and radius dressing requirements for cylindrical, surface, and centerless grinding.

Wheel Forms Dressed by These Tools

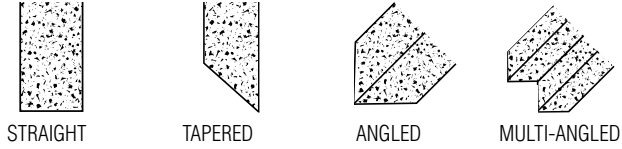

**Synthetic Blade Tools – For USB and Quantum**

- Synthetic diamond with a controlled diamond shape provides a constant cross section of diamond to the wheel throughout the life of the tool
- Provides consistent wheel conditioning from the first dress to last; economical, long-lasting alternative to chisel-type tools for centerless form grinding
- USB (made-to-order) - for dressing aluminum oxide wheels; Quantum (made-to-order) - for dressing ceramics and silicon carbide wheels

**Multi-Cut Blade Tools (Available in Stock and Made-To-Order)**

- Manufactured with top quality natural or processed elongated diamond
- Customizable diamond type depending on wheel specification and application requirements
- Durable performing tools in a medium price range

		TIER: <b>BEST</b>			BETTER	
		TRADENAME: <b>SYNTHETIC BLADE TOOLS</b>			<b>MULTI-CUT TOOLS</b>	
WHEEL DIAMETER (WIDTH <= 9")	TOOL APPROACH ANGLE	SHANK DIAMETER	PRODUCT #	PART #	PRODUCT #	PART #
<b>Blade Tools</b>						
12" to 17"	0°	7/16"	NQ20A7	079587 <b>47944</b> NS		
	15°	7/16"	NQ215A7	079587 <b>47945</b> NS	MC355	662601 <b>95266</b>
18" to 29"	0°	7/16"	NQ30A7	079587 <b>47946</b> NS		
	15°	7/16"	NQ315A7	079587 <b>47947</b> NS		
30" - 36"	0°	7/16"	NQ50A7	079587 <b>47948</b> NS		
	15°	7/16"	NQ515A7	079587 <b>47950</b> NS		

*These stock tools are composed of 1 layer with 3 diamonds. These tools are not resettable or relappable.*

*NS Non-Stock: Please contact your Norton representative for current lead-times.*

*Standard Package = one tool*

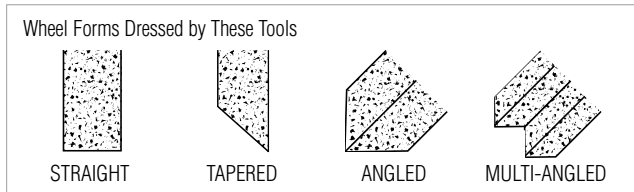

### Form Tools

Norton Winter Form Tools have diamond lapped to specific angles and radii required for a particular application, machine, contour dressing system, or CNC operation. Due to the high degree of accuracy necessary, the diamond is of special shape and quality.

Used tools can be relapped - the tip geometry can be restored on worn tools at a reduced cost.

Wheel Forms Dressed by These Tools



CONVEX



CONCAVE

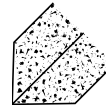

ANGLED



MULTI-ANGLED

### TECH TIP

How to Use Form Dressing Tools

- Proper centerline and light infeeds are essential to minimize side pressure. Excessive pressure will cause the diamond to fracture.
- Cone point tools should be rotated approximately 1/4 turn daily.

Refer to our Diamond and cBN Superabrasive Standard Product Catalog #8068 sections on [www.nortonabrasives.com](http://www.nortonabrasives.com) or ask your Norton representative for information on our made-to-order form tools for the following machines:

- Jones & Lamson
- Hoglund
- Moore Pantograph
- Dia-Form

### Cone Point Tools



### CONE POINT TOOLS

- Norton Winter vacuum braze technology used in the manufacturing surpasses all traditional diamond retention methods
- Absolute diamond retention, diamond pullout prevention during the dressing cycle, and longer tool life through multiple relaps
- Diamond is accurately coned to the specific included angle and radius making these tools ideal when the most intricate, precise forms and radii are required

#### U-Dex-It Cone Point Tool

- Used for precision dressing of intricate forms and radii
- Specially designed with 5/8" indexable head for easy turning during use
- These tools can be relapped

TIER: **BEST**

INCLUDED ANGLE ON DIAMOND	RADIUS ON DIAMOND	TOOL CARAT WEIGHT	SHANK DIAM.	TOOL LENGTH	PRODUCT #	RELAPPABLE PART #
75°	.020"	.50	7/16"	1.678"	CPUD720-7	66260158981

Standard Package = one tool

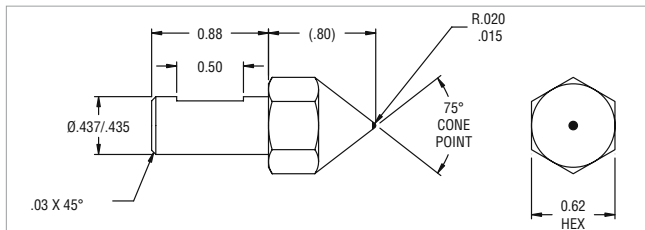

WHEEL FORMS DRESSED BY THESE TOOLS



CONVEX



CONCAVE

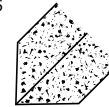

ANGLED



MULTI-ANGLED

### SPEC CHECK

Cone Point Tool Marking System

Tool Type	Included Angle On Diamond	Radius On Diamond	Carat Weight	Shank Diameter
CP	6 = 60°	05 = .005"	L = .10 - .15	6 = 3/8"
	7 = 75°	10 = .010"	M = .20 - .25	7 = 7/16"
	9 = 90°	15 = .015"	H = .33	
		20 = .020"	X = .50	
		25 = .025"		
		30 = .030"		

Example: **CP 6 10 M-6**

### Cone Point Tools *continued*

#### Standard Cone Point Tool

- These tools are used for precision dressing when the most intricate forms and radii are required; can be relapped

TIER: **BEST**

INCLUDED ANGLE ON DIAMOND	RADIUS ON DIAMOND	TOOL CARAT WEIGHT	SHANK DIAM.	TOOL LENGTH	PRODUCT #	RELAPABLE PART #
60°	.010"	.20 - .25	3/8"	2"	CP610M-6	662601 <b>95240</b>

Standard Package = one tool

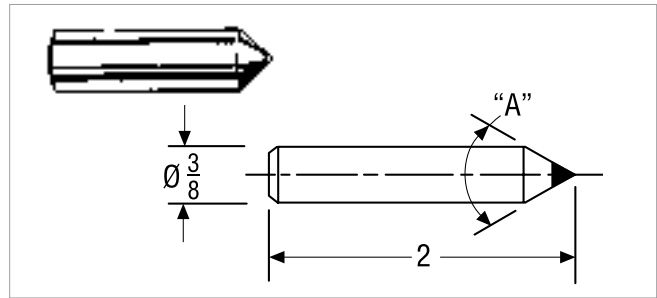

#### Wheel Forms Dressed by These Tools

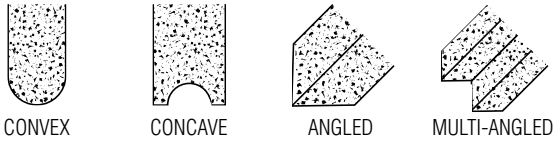

### Chisel Point Tools

#### Chisel Point Tool for Toyoda Grinders

- High-precision chisel point tool designed for forming intricate shapes and radii
- Specifically engineered to fit Toyoda machine series GL32 and GL4, it can also be used on various straight and angle-head grinders – for dressing conventional and ceramic abrasive wheels, sizes 12" to 24"
- This tool can be reset/relapped

TIER: **BEST**

INCLUDED ANGLE ON DIAMOND	RADIUS ON DIAMOND	TOOL CARAT WEIGHT	SHANK DIAM.	TOOL LENGTH	PRODUCT #	RELAPABLE PART #
55°	.020"	.75	7/16"	1.10"	CHT520-7	662601 <b>03741</b>

Standard Package = one tool

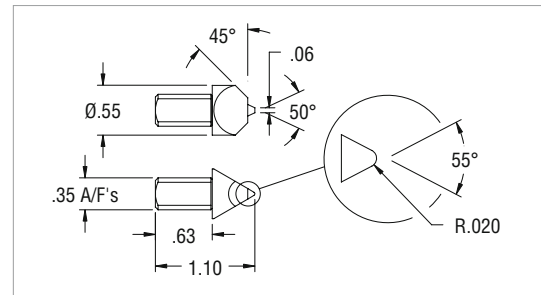

#### Wheel Forms Dressed by These Tools

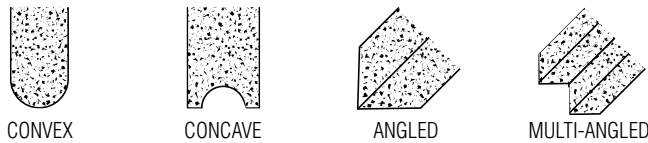

## SPEC CHECK

#### Chisel Point Tool Marking System

Tool Type	Included Angle On Diamond	Radius On Diamond	Carat Weight	Shank Diameter
CH	6 = 60°	05 = .005"	L = .10 - .15	6 = 3/8"
(Natural)	7 = 75°	10 = .010"	M = .20 - .25	7 = 7/16"
Diamond)	9 = 90°	15 = .015"	H = .33	
		20 = .020"	X = .50	
		25 = .025"		
		30 = .030"		

Example: **CH 9 5 M-6**

## TECH TIP

#### Chisel Point Tools

Chisel Point Tools should be rotated 180° when dulling or contour problems occur.

Refer to our Diamond and cBN Superabrasive Standard Product Catalog #8068 sections on [www.nortonabrasives.com](http://www.nortonabrasives.com) or your Norton representative for more in-depth information on all Norton Winter superabrasive stock and made-to-order products.



### Cluster Tools

Norton Winter Cluster tools are designed specifically for straight face dressing of large diameter, coarse grit grinding wheels on single or double disc, centerless, or surface grinders.

Wheel Forms Dressed by These Tools



STRAIGHT TAPERED

### Multi-Point Cluster Tools

- Multi-Point Cluster tools are typically used for straight face dressing on disc and centerless operations
- For greatest efficiency, these tools should be mounted at a 15° angle so that three diamonds are in contact with the wheel face at all times
- The tool should be rotated at frequent intervals; not resettable

TIER: **BETTER**

DIAMONDS ON FACE	SHANK DIAMETER	TOOL LENGTH	PRODUCT #	NON-RESETTABLE PART #
<b>Stock Multi-Point Cluster Tools</b>				
7	7/16"	1-5/16"	NC7K7	662601 <b>95206</b>

Standard Package = 1 Tool

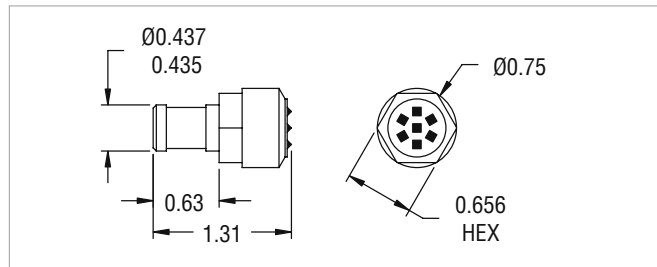

Wheel Forms Dressed by These Tools



STRAIGHT TAPERED

### Dia-Pak Tools

- Dia-Pak tools are primarily used in straight face disc grinding, but are extremely versatile and may also be used in centerless and surface operations
- Designed for maximum economy, three layers of diamond are carefully arranged so that a new layer is exposed before the previous layer is completely worn away; not resettable

TIER: **BETTER**

FOR WHEEL DIAMETERS	DIAMONDS PER LAYER	SHANK DIAMETER	TOOL LENGTH	PRODUCT #	NON-RESETTABLE PART #
<b>Stock Dia-Pak Tools</b>					
Up to 14"	5-4-5	7/16"	2"	DP20	662601 <b>95200</b>
Up to 20"	7-6-7	7/16"	2"	DP30	662601 <b>95201</b>
Any	7-6-7	7/16"	2"	DP35	662601 <b>95202</b>

Standard Package = 1 Tool

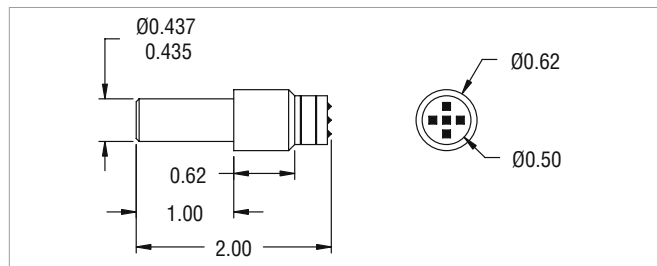

Wheel Forms Dressed by These Tools



STRAIGHT TAPERED

## TECH TIP

Cluster and Dia-Pak Tools – Straight face dressing of hard / coarse wheels:

- Tool should approach the wheel at a 15° angle and be rotated periodically to keep three diamonds in contact with the wheel at all times.
- Tools can also be used at a 90° to the wheel face.
- Multi-Point Cluster tools should be rotated at frequent intervals.
- Infeed per pass should not exceed .0015" (.001" with ceramic – Norton SG, Quantum, Targa TG, etc. – wheels).
- Use coolant whenever possible.
- These tools permit a faster traverse rate providing a freer cutting wheel than when dressed by a single-point tool.



### Tool Holder/Hand Dresser

- Designed for use when offhand truing and dressing on tool and cutter, or benchstand grinders.
- This stock hand dresser will not rust, and is 10-1/2" long, with a hollow shaft that accepts any tool shank length from 3/4" to 9". The 1-3/4" diameter plastic knob ensures a firm grip. The collet accepts a 7/16" diameter tool shank.

DESCRIPTION	PART NUMBER
Hand Dresser	662601 <b>95020</b>

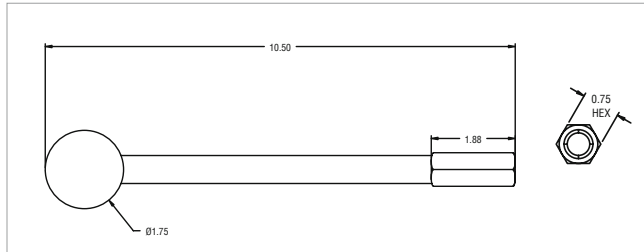



**Open or Closed Dressing... You Can Count on Fliesen Tools**

Whether dressing a wheel OPEN or CLOSED you can count on Fliesen tools. Open wheels (sharp, free-cutting abrasive grains are exposed) are created by increasing the speed a Fliesen tool moves across the wheel when dressing. Generally considered the most favorable wheel conditioning, open wheels avoid workpiece burn while maximizing a wheel's ability to remove metal quickly when grinding.

Slowing a Fliesen tool as it moves across the wheel creates a closed wheel condition (abrasive grains are smoother, less sharp); a very helpful condition when trying to lower part surface finish readings.

- Harder, H-bond metal formulation tools have been specifically engineered to efficiently dress durable silicon carbide and ceramic wheels
- Furioso Fliesen tools have a unique bond system developed for optimal performance when dressing Norton Quantum (NQ) ceramic wheels
- W-bond Fliesen tools are designed for conventional aluminum oxide wheels



**The Benefits of Fliesen Tools**

**Spend More Time Grinding**

Single point, chisel, and cone point tools require operator attention to ensure proper tool rotation at regular intervals. Fliesen tools require no adjustments. Simply install the tool, dress the wheel to break it in, and the tool will do the rest. Operators spend more time grinding – rather than making non-productive dressing adjustments.

**Longer Tool Life**

Expect long life when using a Fliesen tool. Other stationary tools, made with a single diamond stone, develop flat spots ("wear flats") over time – which create chatter and burn. Fliesen tools use hand-set, fine diamond grit, eliminating the creation of wear flats.

**Fliesen Tool Configurations: Plate and Shank**

Fliesen tools are available in two basic tool configurations. The most common is a plate configuration, which is somewhat rectangular-shaped with a mounting hole. Fliesen shank tool configurations are plates mounted in shanks of varying sizes and shapes. Most grinding machines accommodate one or the other tool configuration. To find the correct tool configuration for your machine, check the existing dressing tool, or consult your grinding machine manual.

**Choosing The Correct Fliesen Tool**

Using the chart below, find your desired wheel form – then locate the preferred diamond position. Next, find the correct tool configuration for your machine: plate or shank tool. Follow down that column to find the Fliesen page for your plate or standard shank tool configuration. Go to the appropriate page. Locate the corresponding zone for your wheel diameter and width on the graph. Find that zone number in the part number chart. Next, moving to the right, find your wheel abrasive type and grit size. Locate the part number for your Fliesen tool.

Desired Wheel Form					
Diamond Positions	 Blade Only FR	 Side-Mounted FRS, FAS, FBS, FCS & FDS	 Center-Mounted FAS, FBS, FCS & FDS	 Double-Sided FCSD & FDSD	 Twin FDST, FSST & 1TFAS
<b>TOOL CONFIGURATION</b>					
Plates	 Consult Customer Service	Page 282 – 283	Consult Customer Service	Consult Customer Service	Page 282 – 283
Shank Tools	 Consult Customer Service	Consult Customer Service	Consult Customer Service	Consult Customer Service	Consult Customer Service

**Furioso Tools**

The new generation of highly wear-resistant stationary diamond dressing tools for dressing modern ceramic abrasives

**PERFORMANCE ADVANTAGE**

Furioso vs. Standard Blade

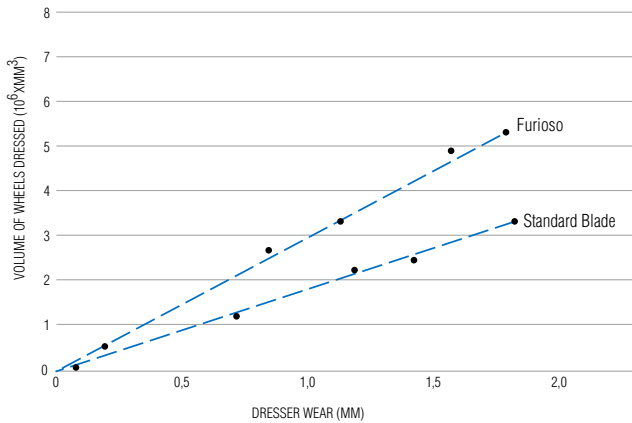

Best choice for optimum performance of Norton Quantum or other ceramic wheels



**FLIESEN FURIOSO TOOLS**

- The optimized combination of diamond quality, bond and setting pattern when dressing Norton Quantum (NQ) or other ceramic grinding wheels
- Improved wear-resistance and enhanced tool life; excellent dressing behavior with optimum consistency
- Constant surface roughness

Standard Furioso Plate Drawings

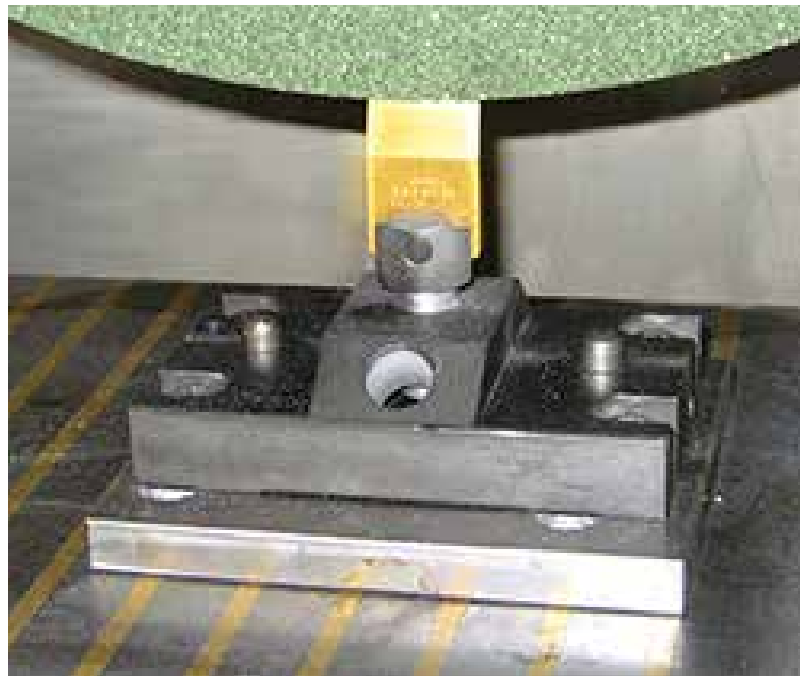
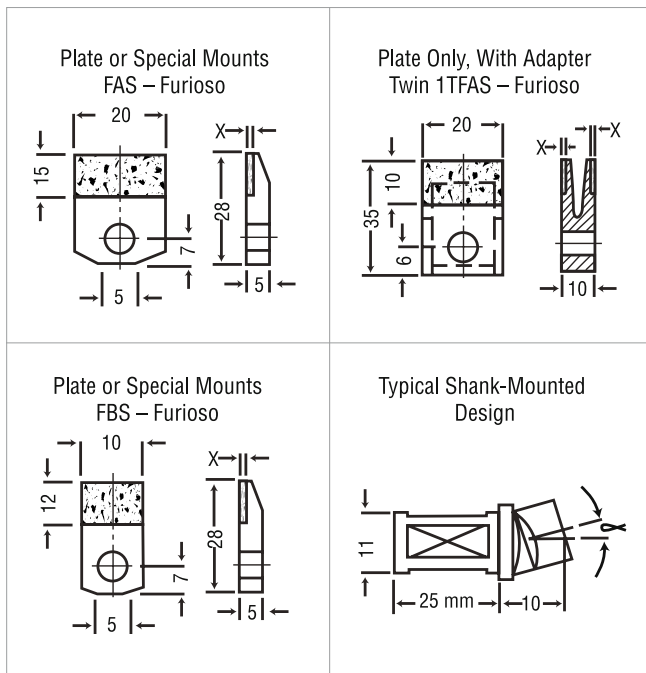

These three pages highlight a small sample of our Fliesen tool offering. Refer to our Diamond and cBN Superabrasive Standard Product Catalog #8068 sections on [www.nortonabrasives.com](http://www.nortonabrasives.com) or ask your Norton representative for complete product listing and information on these tools.

## Furioso Plates; Side-Mounted and Twin

Use the Wheel/Tool Graph to identify your grinding wheel's Zone number, and the chart below to find the Furioso tool for your application.

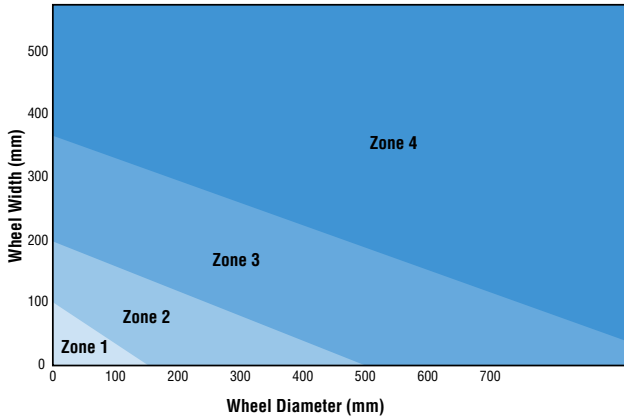

### Wheel / Furioso Tool Graph

Select Zone based on wheel diameter and width



TIER: **BEST**

TO DRESS: **NORTON QUANTUM NQ CERAMIC WHEELS**

ZONE NO. / SERIES	WHEEL GRIT SIZE	TOOL #	PART #	DESCRIPTION
<b>Side-Mounted</b>				
 <b>Zone 2</b> FBS Series	36 - 54	DT1463	690141 <b>22948</b> *	FBS 140 Furioso
	54 - 80	DT1462	690141 <b>22947</b> *	FBS 115 Furioso
	80 - 120	DT1461	690141 <b>22946</b> *	FBS 90 Furioso
	120 - 180	DT1460	690141 <b>22944</b> *	FBS 75 Furioso
 <b>Zone 3</b> FAS Series	36 - 54	DT1467	690141 <b>22952</b> *	FAS 140 Furioso
	54 - 80	DT1466	601576 <b>90579</b> *	FAS 115 Furioso
	80 - 120	DT1465	601576 <b>93885</b> *	FAS 90 Furioso
 <b>Twin</b> <b>Zone 4</b> 1TFAS Series	36 - 54	DT1471	690141 <b>22956</b> *	1TFAS 140 Furioso
	54 - 80	DT1470	690141 <b>22955</b> *	1TFAS 115 Furioso
	80 - 120	DT1469	690141 <b>22954</b> *	1TFAS 90 Furioso
	120 - 180	DT1468	690141 <b>22953</b> *	1TFAS 75 Furioso

\* All Furioso Plates shown ship in 10 business days from receipt of order.

### SPEC CHECK

#### Blade Size

DESCRIPTION	DIMENSION
1 FBS	10 mm thick, 15 mm usable length
2 FAS	20 mm thick, 15 mm usable length
3 TFAS	Twin blade with cooling duct

#### Diamond Grit Size

DESCRIPTION	FEPA
140	D1181
115	D1001
90	D711
75	D501

## Furioso Shank Tools

Made-to-order Furioso shank tools are also available. Ask your Norton representative for ordering assistance.

### Side-Mounted Diamond Sections

Tools are available in different offset positions and angles.



Offset Left,  
Specify  
angle amount

Zero Offset

Offset Right,  
Specify  
angle amount

### Tipping the Diamond Plates on Shank Tools

Diamond sections can be tipped right or left.



Diamond  
Tipped Left,  
Specify angle

Diamond  
Tipped Right,  
Specify angle

There are many different diamonds making up a single plate as this cut-away view shows.



Norton Winter diamond rotary truing and dressing tools provide a very efficient way to modify the shape and topography of your grinding wheels.

**Products:**

- Form Rolls: Plunge Dressing
  - Infiltrated diamond form rolls
  - Reverse plated diamond form rolls
- Dressing Discs: CNC Traverse Dressing
  - Infiltrated dressing discs
  - BPR dressing discs (for dressing superabrasive wheels)
  - IDW dressing discs (for dressing superabrasive wheels)
- Truing and Dressing Spindles and Devices

**Form Roll: Plunge Dressing**

- Diamond roll geometry matches geometry of part to be ground
- Roll is fed into grinding wheel to generate the desired form and wheel surface condition
- Used where lowest cycle time and highest accuracy is required

**Dressing Disc: CNC Traverse Dressing**

- Diamond dressing disc has a thin diamond section that is traversed across the face of the grinding wheel
- Profile is generated with a CNC program or template
- Used for simple profiles or where flexibility is necessary

**How to Order Rotary Dressing Tools**

Provide the following information to your local sales representative or customer service representative

**Legible blueprint of roll, wheel, or part with the following geometry:**

- Overall diameter
- Overall length
- Bore size and tolerances required
- Mounting pattern
- Any feature with tolerances less than 0.0002" (5 um) must be clearly defined for engineering review
- If designing from a part, a fully dimensioned part drawing is required
- Abrasive type (natural diamond, synthetic diamond, CVD stones, etc.)
- Specification of wheel to be dressed (need at least the grit type and size)
- Dressing type (Plunge or CNC Profiling)

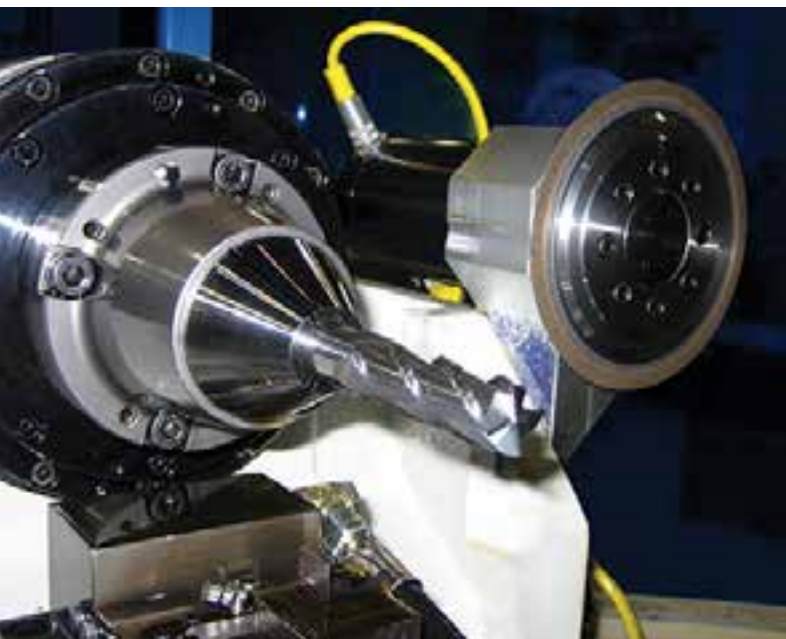

Request the "Rotary Truing and Dressing" brochure, form # 8535, and contact your Norton representative for more information and expert assistance with your dressing operation.



### Brake Controlled Truing Devices

Designed for truing diamond and cBN wheels rapidly, effectively, and with a minimum of superabrasive loss. Recommended for wheels up to 12" in diameter.

**Applications:**

- Truing straight, cup and cylinder wheels:
- Straight wheels, used on chip breaker, tool and cutter, surface, and cylindrical grinding machines
  - Cup wheels, used on vertical spindle surface grinders
  - Internal grinding wheels
  - Cut-off wheels



Visit <https://nortonsga.us/qnfx2> to watch our True to Form, Dress to Cut video.

### Non-Stock 4597 Brake Controlled Truing Device

The 4597 is engineered for heavier and more frequent truing applications. The adjustable speeds allow for varying conditions (between 1050 and 1500 SFPM). It comes complete with a reusable case, two 3" 38A60-M8VBE\* vitrified wheels, Truing Device Tips book and a dressing stick. It can be rebuilt using the 4597RK Rebuild Kit.

Worn #4597 Brake Controlled Truing Devices (UPC 662601**95350**) in need of reconditioning (beyond new shoes and springs) may be returned to be rebuilt. Contact Customer Service for return instructions and quote.

### Stock 3597 Pacesetter Brake Controlled Truing Device

The Pacesetter model is ideal for light-duty use. The pre-set brake speed requires no adjusting. This model includes one 3" 38A60-M8VBE\* vitrified wheel and can be rebuilt using the 3597RK Rebuild Kit.

### Stock 4597RK and 3597RK Rebuild Kits

The truing devices can be rebuilt with these kits, consisting of 3 brake shoes, 3 springs, and 3 screws.

ITEM	TIER: BETTER		GOOD	
	PRODUCT NO.	PART #	PRODUCT NO.	PART #
<b>Truing Devices</b>				
4597 Brake Controlled Truing Device	4597	662601 <b>95350</b> NS		
3597 Pacesetter Brake-Controlled Truing Device	3597	662601 <b>35578</b>		
<b>Truing Device Rebuild Kits</b>				
4597 Rebuild Kit	4597RK	662601 <b>95351</b>		
3597 Pacesetter Rebuild Kit	3597RK	662601 <b>35595</b>		
<b>Replacement Wheels</b>				
3 x 1 x 1/2			38A60-MVBE	662435 <b>29145</b>
			38A80-MVBE	662435 <b>29146</b>
			37C60-MVK	662435 <b>29166</b>
			37C80-HVK	662435 <b>29170</b>
			37C80-MVK	662435 <b>29171</b>
			37C100-HVK	662435 <b>29172</b>
			37C100-MVK	662435 <b>29070</b>

NS Non-Stock: Please contact your Norton representative for current lead-times.

## SPEC CHECK

### Truing Diamond and cBN Wheels

SUPERABRASIVE WHEEL	TRUING WHEEL SPECIFICATION
<b>Resin and Vitrified Bond</b>	
80, 100, and 120 grits	38A60-MVBE 37C60-MVK
150, 180, and 220 grits	38A80-MVBE 37C80-MVK
320 and finer grits	37C100-HVK
<b>Metal Bond</b>	
80, 100, and 120 grits	38A60-MVBE
150, 180, and 220 grits	38A80-MVBE
240 and finer grits	37C80-HVK

## TECH TIP

- Prior to truing the wheel, run a wax crayon over the wheel face. Important: do NOT use any liquid-based ink on superabrasive wheels.
- Any crayon left on the wheel face after truing will reveal untrued areas.
- Indicate the superabrasive wheel runout before starting... usually within .001" to .002", to minimize wheel loss.
- Mount the device spindle parallel to the wheel spindle to ensure proper straight face truing.
- For cup-shaped wheels, the device spindle will be mounted perpendicular to the wheel spindle.
- Always use the brake-controlled truing device dry.
- Bring the diamond/cBN wheel and the truing wheel together until they almost touch.
- Start the diamond/cBN wheel to normal speed; spin the truing wheel in the same direction at point of contact.
- Bring the two wheels together until they touch.
- Make sure the truing wheel is spinning at time of contact.
- Traverse the wheel back and forth at 30 to 60 inches/minute.
- Downfeed .0005" to .001" at the end of each traverse.
- At the end of truing, the diamond/cBN wheel should be smooth and in truth.
- Apply a dressing stick to sharpen the wheel.



It is the user's responsibility to refer to and comply with ANSI B7.1



Regular use of properly selected dressing sticks will help you achieve maximum performance from your grinding wheels.

**Applications:**  
**Grit range:**  
**Abrasive grain:**  
**Shape:**  
**Machine Used:**

Truing, cleaning, and dressing diamond, cBN, and conventional abrasive grinding wheels  
16 – 1200  
Aluminum Oxide, Boron Nitride, Silicon Carbide  
Square, rectangular, and round



HAND DRESSING

## Grinding Wheel-to-Product Recommendation Guide

Selecting the appropriate dressing stick for each application depends on the wheel size, type, speed, specification, and grit size, as well as the workpiece material. Initial starting specifications are listed below. We recommend testing several sticks to find the best one for your application.



	Product	Specification
<b>Superabrasive Wheels - Resin and Vitrified Bond</b>		
- 80, 100, and 120 grits	Dressing Stick	38A150-HVBE
- 150, 180, and 220 grits	Dressing Stick	38A220-HVBE
- 320 and finer grits	Superfine Stick	NMVC400-J5VCA
<b>Superabrasive Wheels - Metal Bond</b>		
- 80, 100, and 120 grits	Dressing Stick	37C80-NV
- 150, 180, and 220 grits	Dressing Stick	37C150-KV
- 240 and finer grits	Dressing Stick	37C220-KV
<b>Conventional Vitrified Wheels - Vitrified Bond</b>		
- 46 grit and finer and M grade and softer	High Performance Dressing Stick	Norbide
	Conventional Dressing Stick	37C24-SVK

## TECH TIP

### Dressing Diamond and cBN Wheels

- Resin and Vitrified Bond Diamond, and cBN Wheels: choose a dressing stick one or two grit sizes finer than the abrasive in the wheel – in a soft grade (H or I)
- Metal Bond Diamond, and cBN Wheels: choose a stick the same grit size or one grit size coarser than the abrasive in the wheel – in a medium grade (K–M)



It is the user's responsibility to refer to and comply with ANSI B7.1

## Offhand Grinding Wheel Dressing Stick and Holder

This convenient metal holder is widely used by mechanics and foundry-men for truing, dressing and changing the face of the wheel. The JT246 dressing stick – an extra coarse grit silicon carbide for dressing conventional vitrified wheels – is firmly held and adjusted by the knurled control.



SIZE (D x L)	SPEC.	STD. PKG.	TIER: BETTER	
			PRODUCT #	PART #
<b>Offhand Grinding Wheel Dressing Stick and Holder</b>				
1/2 x 6 Round	Silicon Carbide Extra Coarse Grit Round Dressing Stick	5	JT246	614636 <b>87900</b>
10 Overall	Dressing Stick Holder	5	H6	614636 <b>87895</b>

## Norbide High-Performance Sticks

For offhand truing and dressing of medium grit, soft- and medium-grade conventional vitrified grinding wheels. Norton Norbide sticks are the hardest sticks you can buy. Made from boron nitride, they are well suited for dressing tool and cutter wheels 10" and smaller, especially cup and saucer shapes.

SIZE (T x W x L*)	STD. PKG.	TIER: BETTER	
		SPEC.	PART #
<b>High Performance Long Life Stick</b>			
1/4 x 1/2 x 3	5	Norbide	614636 <b>10148</b>

\* Thickness x Width x Length

## Vitrified Dressing Sticks

### Aluminum Oxide (White)

For dressing and cleaning diamond and cBN superabrasive wheels.

### Silicon Carbide (Black)

Coarse grit (16 - 46) and hard-grade (R and harder) sticks are used for dressing conventional vitrified wheels. Finer grit and softer grades are used for dressing diamond wheels.

SIZE (T x W x L)	TIER: BETTER		PART #
	STD. PKG.	SPEC.	
<b>Vitrified Dressing Sticks – Aluminum Oxide</b>			
3/8 x 3/4 x 4	5	38A150-IVBE	614636 <b>39635</b>
1/2 x 1/2 x 4	5	38A220-HVBE	614636 <b>10555</b>
1/2 x 1/2 x 6	5	38A150-IVBE	614636 <b>10303</b>
	5	38A220-HVBE	614636 <b>10103</b>
1/2 x 3/4 x 4	5	38A60-LVBE	614636 <b>10415</b>
1/2 x 1 x 4	5	38A180-IVBE	614636 <b>99705</b>
3/4 x 3/4 x 4	5	38A60-LVBE	614636 <b>10440</b>
	5	38A80-MVBE	614636 <b>10362</b>
	5	38A90-LV	614636 <b>39632</b>
	5	38A150-HVBE	614636 <b>10291</b>
	5	38A150-IVBE	614636 <b>10368</b>
	5	38A220-HVBE	614636 <b>10290</b>
	5	38A220-HVBE	614636 <b>10280</b>
3/4 x 3/4 x 8	5	38A220-HVBE	614636 <b>10280</b>
1 x 1 x 6	5	38A150-HVBE	614636 <b>10405</b>
	5	38A150-IVBE	614636 <b>10453</b>
	5	38A220-HVBE	614636 <b>10406</b>
1 x 1 x 8	5	38A120-IVBE	614636 <b>10390</b>
	5	38A150-IVBE	614636 <b>10455</b>

SIZE (T x W x L)	TIER: BETTER		PART #
	STD. PKG.	SPEC.	
<b>Vitrified Dressing Sticks – Silicon Carbide</b>			
1/2 x 1/2 x 6	5	37C24-SVK	614636 <b>10285</b>
	5	37C100-LV	614636 <b>10201</b>
	5	37C150-KV	614636 <b>10205</b>
	5	37C150-LV	614636 <b>10206</b>
	5	37C150-MV	614636 <b>10207</b>
	5	37C220-KV	614636 <b>10214</b>
	5	37C150-LV	614636 <b>10375</b>
	5	37C20-SVK	614636 <b>10459</b>
	5	37C24-SVK	614636 <b>10462</b>
	5	37C24-TVK	614636 <b>10354</b>
3/4 x 3/4 x 6	5	37C46-RVK	614636 <b>10466</b>
	5	37C80-NV	614636 <b>10393</b>
	5	37C150-KV	614636 <b>10438</b>
	5	37C220-KV	614636 <b>10398</b>
	5	37C20-SVK	614636 <b>10469</b>
	5	37C24-SVK	614636 <b>10471</b>
	5	37C16-TVK	614636 <b>10482</b>
1 x 1 x 6	5	37C24-TVK	614636 <b>10485</b>
	5	37C24-SVK	614636 <b>10490</b>
1 x 1 x 8	5	37C20-SVK	614636 <b>10469</b>
1 x 2 x 8	5	37C24-SVK	614636 <b>10471</b>
2 x 2 x 8	5	37C16-TVK	614636 <b>10482</b>
<b>Vitrified Round Dressing Sticks – Silicon Carbide</b>			
1/2 x 6	5	37C24-SVK	614636 <b>10371</b>
1 x 6	5	S/C Ex-C (JT276)	614636 <b>87905</b>

## Vitrified Superfine Sticks

For dressing diamond and cBN superabrasive wheels.

SIZE (T x W x L)	TIER: BETTER		PART #
	STD. PKG.	SPEC.	
<b>Vitrified Superfine Sticks – Aluminum Oxide</b>			
1 x 1 x 6	5	PCD Coarse - 400 grit	614636 <b>47865</b>
	5	PCD Fine - 800 grit	614636 <b>47867</b>
1 x 1 x 8	5	NSA320-H8V	614636 <b>10597</b>
<b>Vitrified Superfine Sticks – Silicon Carbide</b>			
1/2 x 1/2 x 6	5	NMVC320-J5VCA	614636 <b>10599</b>
	5	NMVC400-J5VCA	614636 <b>50324</b>
1 x 1 x 6	5	NMVC320-J5VCA	614636 <b>10605</b>
	5	NMVC400-J5VCA	614636 <b>50450</b>

## Organic Silicon Carbide Micro Dressing Wheel

Type 01 straight dressing wheels with sharp high-purity green silicon carbide abrasive.

For micro-dressing fine grit polyimide superabrasive diamond wheels.

TIER: **BEST**  
ABRASIVE: Silicon Carbide

SIZE (D x T x H)	MAX. RPM	MIN./STD. PKG.	SPEC.	PART #
<b>Type 01 Straight</b> 				
200mm x 10mm x 31.75mm	2,870	5	320 Silicon Carbide Organic Micro Dressing Wheels	662532 <b>96349*</b>

\* For fine grit diamond Polyimide wheels

For additional silicon carbide wheels that can be used for dressing see page 242 in the Precision Grinding Silicon Carbide Toolroom Wheels section

**Diamond and cBN Wheel Mounting, Truing and Dressing Guide**

To achieve the best results using Norton Winter diamond and cBN products, the following steps for mounting, truing and dressing should be practiced:

**MOUNTING – Putting Wheel on Machine Spindle**

- Examine wheel flanges and spindle carefully.
- Be sure flanges' surfaces are clean and free of damage.
- Ensure that the mounting flanges are flat and of equal diameter, especially on wheels with rigid centers, such as vitrified bond wheels.
- Paper or plastic blotters should only be used when mounting superabrasive wheels with vitrified cores. Using paper or plastic blotters on any other core material might result in the wheel loosening during grinding.
- Inspect machine spindle for excessive runout.
  - » TIR (Total Indicated Runout) should be no greater than 0.0002".
- Mount wheel between hand-tightened flanges.
- Using a dial indicator, tap the wheel lightly with a rubber or wooden block to minimize runout to less than .0010".

**TRUING – Making Wheel Round and Concentric with the Spindle Axis**

- Prior to truing the wheel, run a wax crayon over the wheel face. Important: do not use any liquid-based ink on superabrasive wheels.
- Any crayon left on the wheel face after truing will reveal untrued areas.
- Indicate the superabrasive wheel runout before starting... usually within .001" to .002", to minimize wheel loss.
- Brake controlled truing devices are most commonly used to true Diamond and cBN straight, cup and cylinder wheels.
  - » Mount the device spindle parallel to the wheel spindle to ensure proper straight face truing.
  - » For cup wheels, the device spindle will be mounted perpendicular to the wheel spindle.
  - » Always use brake controlled truing device dry.

**DRESSING – Opening the Face of a Trued Wheel**

- Dressing the abrasive – a cleaning/sharpening process to expose sharp, free-cutting grit:
  - » For resinoid and vitrified bond wheels, the dressing stick should be one or two grit sizes finer than the abrasive in the diamond/cBN wheel – in a soft grade such as H or I.
  - » For metal bond wheels, choose a stick with the same grit or one grit coarser than the wheel abrasive – in a medium grade (K – N).
  - » See the "Dressing Stick" section for recommendations.

- Tighten flange securely and recheck with indicator.
- Allow a newly mounted wheel to operate for one full minute before grinding.
- The use of one permanent mounting for the life of the wheel is recommended whenever possible:
  - » If the grinding machine has a tapered spindle, mount each straight, flaring cup or dish wheel on a separate collet or adapter.
  - » When changing wheels the entire unit is removed, keeping the wheel in running truth.
  - » When needed again, the entire unit can be placed directly on the spindle or arbor, thereby eliminating the time and abrasive lost in retruing.

- » Bring the diamond/cBN wheel and the truing wheel together until they almost touch.
- » Start the diamond/cBN wheel to normal speed; start the truing wheel in the same direction.
- » Bring the two wheels together until they touch.
- » Make sure the truing wheel is spinning at time of contact.
- » Traverse the wheel back and forth at 30 to 60 inches per minute.
- » Downfeed .0005" to .001" at the end of each traverse.
- » At the end of truing, the diamond/cBN wheel should be smooth and in truth.
- » Apply a dressing stick to sharpen the truing wheel.

- Dressing the core – The core material (the part of the wheel that holds and supports the abrasive-bearing section) should never contact the work piece during grinding; rubbing will generate excessive heat. As the abrasive section of a cup wheel wears, the core material might become exposed, necessitating dressing.
  - » Use a single-point carbide or steel tool to dress an exposed resalloy core.
  - » Clamp the tool in a vise.
  - » Direct the cutting edge accurately to leave a 1/16" of abrasive section exposed.

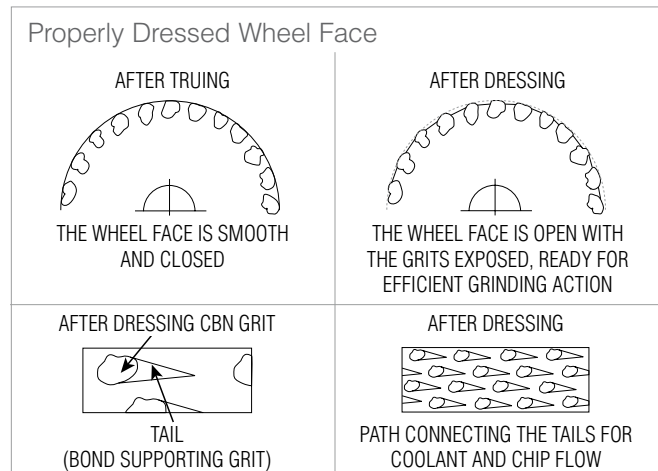





setting a new  
industry standard  
**FOR PRODUCTIVITY**

From the most comprehensive stock offering to the industry's largest custom-manufactured availability, our Norton Winter superabrasive product portfolio gives you the most options with uncompromising performance.

- Diamond / cBN Stock Wheels
- B99 Express Made-to-Order Resin Wheels
- CNC Wheels
- Electroplated Products
- Lapping Compound

**Norton Winter Diamond Product Identification System / Usage Information**

ASD 120 – R 75 B99 1/8

Abrasive Type	Grit Size	Grade	Concentration	Bond	Abrasive Depth
<b>ASD</b> <ul style="list-style-type: none"> <li>Used with B99 and B105 bonds</li> <li>Armored</li> <li>Durable</li> <li>Versatile</li> <li>Use wet or dry</li> <li>Carbide/steel operations</li> </ul>	<ul style="list-style-type: none"> <li>100S – Roughing</li> <li>120 – Roughing/cutting-off</li> <li>150 – Combined roughing and finishing</li> <li>180 – Improving finish</li> <li>220, 320 &amp; 400 – Finishing only</li> <li>10/20 mic</li> <li>6/12 mic</li> </ul>	<b>Resin Bond</b> R – Norton standard N – Free cutting <b>Metal Bond</b> N – Norton standard <b>Vitrified Bond</b> P – Norton standard R – Most durable	<b>50</b> <ul style="list-style-type: none"> <li>Most economical</li> <li>For broad area of contact</li> </ul> <b>75</b> <ul style="list-style-type: none"> <li>Norton standard</li> <li>Freer cutting than 100</li> <li>Dry grinding with ASD</li> </ul> <b>100</b> <ul style="list-style-type: none"> <li>Very durable</li> <li>For flood coolants</li> <li>Use with 220 grit or finer</li> <li>Use for cutting-off</li> </ul> <b>115</b> <ul style="list-style-type: none"> <li>For CNC grinding machines</li> </ul> <b>125</b> <ul style="list-style-type: none"> <li>Form holding</li> <li>For high volume, high pressure coolant, precision applications on high-speed tool steels</li> </ul>	<b>B99</b> <ul style="list-style-type: none"> <li>Resin bond</li> <li>Use wet or dry</li> <li>Tool making; resharpening</li> </ul> <b>B105</b> <ul style="list-style-type: none"> <li>Premium resin bond</li> <li>Advanced heat-reducing bond</li> <li>Use dry; reconditioning</li> </ul> <b>B610 and B80</b> <ul style="list-style-type: none"> <li>For CNC grinding machines</li> </ul> <b>M99</b> <ul style="list-style-type: none"> <li>Metal bond</li> <li>1A1R cut-off</li> <li>Glass and ceramics</li> </ul> <b>MSL</b> <ul style="list-style-type: none"> <li>Metal single layer</li> <li>Type 6A2C only</li> <li>Use dry</li> <li>Offhand reconditioning/finishing carbide</li> </ul> <b>V99</b> <ul style="list-style-type: none"> <li>Vitrified bond</li> <li>Offhand finishing of carbide tools</li> <li>Plunge grinding</li> </ul>	1/16" 1/8" 1/4" 9/32" 3/8" 1/2" 3/4" Solid
<b>CD</b> <ul style="list-style-type: none"> <li>Used with B99 bond</li> </ul>					
<b>D</b> <ul style="list-style-type: none"> <li>Used with B99 bond</li> <li>Micron-sized diamond; finishing</li> </ul>					
<b>M3D</b> <ul style="list-style-type: none"> <li>Used with M99 bond</li> </ul>					
<b>M4D</b> <ul style="list-style-type: none"> <li>Used with M99 bond</li> <li>Armored</li> <li>Durable; for non-metallics</li> </ul>					
<b>RMD</b> <ul style="list-style-type: none"> <li>Used with V99 bond</li> </ul>					
<b>SD</b> <ul style="list-style-type: none"> <li>Used with B99 and V99 bonds</li> <li>Norton standard</li> <li>Use wet or dry</li> <li>Free cutting</li> <li>Low horsepower (3/4 hp or less)</li> </ul>					

**Norton Winter cBN Product Identification System / Usage Information**

CB 120 – T B99 1/8

Abrasive Type	Grit Size	Grade	Bond	Abrasive Depth
<b>CB – cubic Boron Nitride</b> <ul style="list-style-type: none"> <li>Used with B99 bond</li> <li>Armored</li> <li>Use wet or dry</li> </ul>	<ul style="list-style-type: none"> <li>100 – Roughing</li> <li>120 – Roughing/cutting-off</li> <li>150 – Combined roughing and finishing</li> <li>180 – Improving finish</li> <li>220, 320, 400 – For finishing only</li> </ul>	<b>Q</b> <ul style="list-style-type: none"> <li>Approx. 50 concentration</li> <li>Type 6A2</li> <li>Broad area of contact</li> </ul> <b>T</b> <ul style="list-style-type: none"> <li>Approx. 75 concentration</li> <li>Norton standard</li> <li>First choice</li> <li>Lower horsepower</li> <li>Broad area of contact</li> <li>Dry grinding</li> <li>Resharpening applications</li> </ul> <b>W</b> <ul style="list-style-type: none"> <li>Approx. 100 concentration</li> <li>Most durable</li> <li>High volume coolant</li> <li>Flute polishing</li> <li>Surface grinding</li> <li>Cylindrical grinding</li> </ul>	<b>B99</b> <ul style="list-style-type: none"> <li>Resin bond</li> <li>Use wet or dry</li> </ul> <b>Aztec III</b> <ul style="list-style-type: none"> <li>Premium resin bond</li> <li>Use dry</li> <li>Tool resharpening</li> </ul> <b>Aztec .007</b> <ul style="list-style-type: none"> <li>Premium resin bond</li> <li>Use dry</li> <li>Increased feed rates</li> <li>Heavy stock removal</li> <li>Heavier cuts</li> </ul>	1/16" 1/8" 1/4" 1/2" Solid

### Application-to-Product Recommendation Guide – Diamond Wheels

APPLICATION OR COMMON MACHINE TYPE	COMMON WHEEL SIZE, TYPE & BLUEPRINT	APPLICATION VARIABLES	RECOMMENDED SPECIFICATION	
<b>Carbide Grinding – Toolroom Production</b>				
Blanchard Grinding Vertical Spindle Surface Grinding	10", 11", 16" & 18" diameters Type 2A2T	Wet – solid carbide	1" or larger pieces – roughing	SD100-R75B99E*
			Small pieces	ASD100-R75B99E*
Hand Burr Grinding	6" x 3/32" x 1-1/4" Type 1V1P V – 20° ME89562	Dry	Carbide & steel (combination)	ASD100-R75B99E*
				ASDC320B-R125B99
Centerless (wet)	Throughfeed Grinding	Roughing		ASD100-R75B99E*
	Unison Dedtru Grinder			ASD150-R75B99E*
Cutting Off (wet)	6" x .035" x 1-1/4" Type 1A1R ME43572	Most durable		ASD100S-R100B99
		Free cutting		SD100-R75B99
				SD120-R100B99
Cylindrical Grinding (wet)	10", 12", 14", 16" & 20" diameters Type 1A1	Wet, rough grinding of cemented carbides, hard (55 Rc+) plasma and ceramic spray coatings		ASD180-R100B99
				ASD180-R75B99E*
				ASD150-R75B99
				ASD120-R75B99
Tool Sharpener Bench Grinder (wet)	5" x 1" x 1-1/4" Type 6A2H ME27084 Rim Width (W) = 1-1/16	Tool sharpening		SD320-R50B99
Hand Honing (dry)	Various sizes Type HH1 or HH2			ASD100-R100B99 SD320-100V99
Lamination Dies (wet)	Various sizes Type 1A1	Surface grinding of carbide		ASD120-R75B99
Surface Grinding (wet) Straight Wheels	Various sizes Type 1A1	Roughing	Durable	ASD100S-R100B99E*
			Free cutting	SD100S-R100B99
		Finishing only		SD220-R100B99
		General purpose		ASD150-R75B99
Tool & Cutter Grinding	Various sizes Type 11V9, 12V9 or 15V9	Wet or dry		ASD120-R7599
<b>Carbide Grinding – Offhand</b>				
Single-Point Carbide Tools	6" x 3/4" x 1-1/4" Type 6A2C ME27853	Wet roughing	Durable	RMD150-P50V99*
			Free cutting	SD150-P50V99
		Wet finishing	Durable	RMD220-P50V99*
			Free cutting	SD220-P50V99
		Wet or dry grinding where free-cutting and self-dressing wheels are required	Roughing	ASD120-R75B99
			Finishing	SD220-R50B99E*

Note: Diamond depths are not indicated in above listings. When ordering, be sure to include Diamond depth (1/16, 1/8, etc.).

\*Express Made-To-Order; Refer to the B99E Express Made-to-Order Wheel section.

### Application-to-Product Recommendation Guide – cBN Wheels

APPLICATION OR COMMON MACHINE TYPE	COMMON WHEEL SIZE, TYPE & BLUEPRINT	APPLICATION VARIABLES	RECOMMENDED SPECIFICATION
<b>Toolroom Grinding</b>			
Cutter Sharpening	3-3/4" x 1-1/2" x 1-1/4" Type 11V9 ME92192	Dry	Aztec III 120T
Milling Cutters, Broaches, Reamers, etc.	6" x 1" x 1-1/4" Type 12A2 ME27758	Wet	CB120-TB99
	6" x 3/4" x 1-1/4" Type 12V9 ME48666	Wet or dry	CB120-TB99
	6" x 3/4" x 1-1/4" Type 15V9 ME40633	Wet or dry	CB100-WB99E*
Surface Grinding	10" x 1/2" x 3" Type 1A1	Wet or dry	CB100-TB99E*
Cylindrical Grinding	12" x 1/2" x 3" Type 1A1	Wet or dry	CB150-WB99E*
Internal Grinding Tools	Thinner than 1/2" Type DW	Wet or dry	CB100-WB99
	1/2" or thicker Type 1A1	Wet or dry	CB120-TB99E*
Slotting	7" x .040" x 1-1/4" Type 1A1R	Water-base coolant	CB120-WB99E*

*Note: cBN depths are not indicated in above listings. When ordering, be sure to include cBN depth (1/16, 1/8, etc.)*

*\*Express Made-To-Order; Refer to the B99E Express Made-to-Order Wheel section.*

**Troubleshooting Guide – Dry Grinding**

Problem	Possible Causes	Suggested Correction
Burning (excessive heat)	Wheel loaded or glazed	Dress wheel with a dressing stick
	Excessive feed rate	Reduce infeed of wheel or workpiece
	Wheel too durable	Use freer cutting specification or slow down wheel speed
Poor finish	Grit size too coarse	Select a finer grit size
	Excessive feed rate	Reduce infeed of wheel or workpiece
Chatter	Wheel out of truth	True wheel; ensure it is not slipping on mount (See “Mounting, Truing and Dressing Guide”)

**Troubleshooting Guide – Wet Grinding**

Problem	Possible Causes	Suggested Correction
Burning (excessive heat)	Wheel glazed or loaded	Re-dress wheel
	Poor coolant placement	Apply coolant directly to wheel/workpiece interface
	Excessive material removal rate	Reduce downfeed and/or crossfeed
Poor finish	Excessive dressing	Use lighter dressing pressure Stop dressing as soon as wheel starts to consume stick rapidly
	Grit size too coarse	Select a finer grit size
	Poor coolant flow or location	Apply heavy flood so it reaches wheel/work interface
Chatter	Wheel out of truth	True wheel; ensure it is not slipping on mount
Wheel will not cut	Glazed by truing	Dress lightly until wheel opens up
	Wheel loaded	Dress lightly until wheel opens up Increase coolant flow to keep wheel surface clean Never run wheel with coolant turned off
	Low feeds and speeds	Increase feed rate; increase wheel speed (Do not exceed wheel MOS)
	Incorrect coolant flow	Apply coolant to flood wheel/work surface
Slow cutting	Low wheel speed	Increase wheel speed (observe maximum operating speed)
Short wheel life	Excessive dressing	Use lighter dressing pressure
	Wheel too soft or too hard	Change grit or grade; use higher concentration

**Material Hardness Scale**

Superabrasives is a term used to describe those abrasives of extreme hardness which produce outstanding results when properly used on specific applications. This graph provides a hardness comparison (Knoop Hardness Scale) between diamond and cBN superabrasives, aluminum oxide and silicon carbide standard abrasives, and some common materials these abrasives are used to grind.

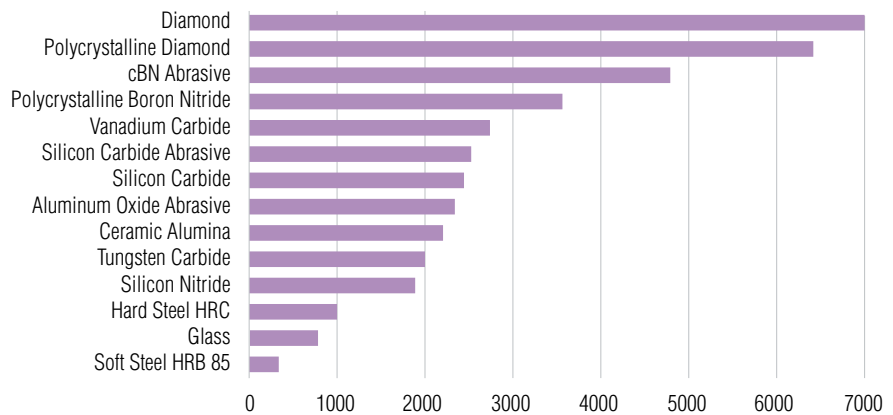

**TECH TIP**

**Avoid Grinding Steel**

- Avoid steel when grinding with diamond wheels. Keep the amount of steel ground to an absolute minimum.
- On brazed tools, use aluminum oxide wheel to back off the steel shank.
- A high lubricity grinding fluid should be used.
- For some steels, an armored (AMD) diamond wheel might prove most economical.

**Use Rigid Work Support**

- All workpieces should be supported firmly during the grinding process. Any amount of vibration will cause wheel wear and produce chatter or wave marks on the ground surface.
- On work ground between centers, centerholds should be properly prepared.
- Minimize work overhang.
- If the ground work is supported by a work finger, ensure the finger is strong enough to provide vibration-free support.

**Coolant – Grind Wet**

- Diamond wheels should be used with a full flood coolant properly directed toward the grinding zone. Water with a rust inhibitor is recommended.
- Vitrified diamond wheels should be used only with a coolant.
- When flood application can't be used, try mist or spray application.
  - » Use compressed air to "atomize" water or soluble oil.
  - » Direct the spray at the grinding zone to help dissipate heat and prevent heat damage to the work.

**Avoid Excessive Feeds**

- Excessive feeds will result in premature wheel wear. Excessive feed rates are characterized by:
  - » A hard grinding sound
  - » Chatter
  - » Burn
  - » High wheel wear rate
  - » Vibration

### Decimal and Metric Equivalents of Common Fractions

FRACTIONS OF AN INCH	DECIMALS OF AN INCH	MILLIMETERS
1/64	.0156	0.397
1/32	.0313	0.794
3/64	.0469	1.191
1/16	.0625	1.588
5/64	.0781	1.985
3/32	.0938	2.381
7/64	.1094	2.778
1/8	.1250	3.175
9/64	.1406	3.572
5/32	.1563	3.969
11/64	.1719	4.366
3/16	.1875	4.762
13/64	.2031	5.159
7/32	.2188	5.556
15/64	.2344	5.953
1/4	.2500	6.350
17/64	.2656	6.747
9/32	.2813	7.144
19/64	.2969	7.541
5/16	.3135	7.937
21/64	.3281	8.334
11/32	.3438	8.731
23/64	.3594	9.128
3/8	.3750	9.525
25/64	.3906	9.922
13/32	.4063	10.319
27/64	.4219	10.716
7/16	.4375	11.112
29/64	.4531	11.509
15/32	.4688	11.906
31/64	.4844	12.303
1/2	.5000	12.700
33/64	.5156	13.097
17/32	.5313	13.494
35/64	.5469	13.891
9/16	.5625	14.287
37/64	.5781	14.684
19/32	.5938	15.081
39/64	.6094	15.478
5/8	.6250	15.875
41/64	.6406	16.272
21/32	.6563	16.688
43/64	.6719	17.085
11/16	.6875	17.462
45/64	.7031	17.859
23/32	.7188	18.256
47/64	.7344	18.653
3/4	.7500	19.050
49/64	.7645	19.447
25/32	.7813	19.843
51/64	.7969	20.240
13/16	.8125	20.637
53/64	.8281	21.034
27/32	.8438	21.430
55/64	.8594	21.827
7/8	.8750	22.224
57/64	.8906	22.621
29/32	.9063	23.018
59/64	.9219	23.415
15/16	.9375	23.812
61/64	.9531	24.209
31/32	.9688	24.606
63/64	.9844	25.003
1	1.0000	25.400

### Expected Surface Finish by Grit Size

Use these charts as guides only. Surface finish is affected by several variables: machine type and condition, type of material ground, coolant, wheel speed, bond system, etc.

#### DIAMOND

Grit Size	Expected Finish Micro Inch AA	Maximum Depth of Cut per Pass for Grit Size
100	24 to 32	0.001" to 0.002"
120	16 to 18	0.001" to 0.002"
150	14 to 16	0.001" to 0.002"
180	12 to 14	0.0007" to 0.001"
220	10 to 12	0.0007" to 0.001"
320	8	0.0004" to 0.0006"
400	7 to 8	0.0003" to 0.0005"

#### cBN

Grit Size	Expected Finish With Oscillation	Expected Finish Plunge
100	35 – 40	40 – 45
120	30 – 35	35 – 40
150	25 – 30	30 – 35
180	20 – 25	25 – 30
220	15 – 20	20 – 25
320	10 – 15	15 – 20
400	4 – 8	5 – 10

### Recommended Wheel Speeds for Diamond and cBN Wheels

#### WET GRINDING

	Cup Wheels 11V9, 12V9, 15V9, etc.	Peripheral Wheels 1A1, 1V1, 1A1R, etc.
<b>Diamond Grinding Wheels</b>		
Resin Bond Wheels	4921 to 7874 SFPM 25 to 40 m/s	4921 to 7874 SFPM 25 to 40 m/s
Metal Bond Wheels		3937 to 5906 SFPM 20 to 30 m/s
Vitrified Bond Wheels	2953 to 5906 SFPM 15 to 30 m/s	2953 to 5906 SFPM 15 to 30 m/s

#### cBN Grinding Wheels

	Cup Wheels 11V9, 12V9, 15V9, etc.	Peripheral Wheels 1A1, 1V1, 1A1R, etc.
<b>Diamond Grinding Wheels</b>		
Resin Bond Wheels	5906 to 9843 SFPM 30 to 50 m/s	5906 to 9843 SFPM 30 to 50 m/s
<b>DRY GRINDING</b>		
<b>Diamond Grinding Wheels</b>		
Resin Bond Wheels	2756 to 3543 SFPM 14 to 18 m/s	2756 to 3543 SFPM 14 to 18 m/s
<b>cBN Grinding Wheels</b>		
Resin Bond Wheels	2953 to 5906 SFPM 15 to 30 m/s	2953 to 5906 SFPM 15 to 30 m/s

Note: These are not the maximum operating speeds (MOS).

Consult ANSI B7.1 or contact your Norton representative for MOS.

### Wheel Speed Calculation

To convert M/S to SFPM:	Multiply M/S x 196.85 = SFPM
To convert SFPM to M/S:	Divide SFPM by 196.85 = M/S
To convert RPM to SFPM:	Multiply wheel diameter in inches x RPM x 0.262
M/S = meters/second    RPM = Revolutions Per Minute    SFPM = Surface Feet Per Minute	



Norton Winter offers an extensive line of stock Diamond and cBN (cubic Boron Nitride) grinding products, including resin, vitrified, metal and MSL (metal single layer) bond offerings, under the "99" quality line. Premium, high-performance stock resin bond options are also available.

**Applications:**

- B99 Diamond Wheels**
- Sharpening cemented carbide cutting tools
  - Cutting off carbide rod
  - Grinding or cutting off non-ferrous materials such as ceramics or glass
  - Surface grinding dies
  - O.D. grinding spray coatings

**B99 cBN Wheels**

- Sharpening high-speed (M2, D2, T15, etc.) steel cutting tools
- Surface and ID grinding hardened steel die components
- Precision grinding steel parts Rc 50 or harder

**Stock Shapes:**

DW Mounted Points, HH1 and HH2 Hand Hones, and 1A1, 1A1R, 1V1P, 4A2P, 6A2C, 6A2H, 11V9, 12A2, 12V9, and 15V9 Wheels

**Abrasive Grain:**

Diamond and cBN (cubic Boron Nitride)

**Abrasive Bonds:**

Resin, Metal, Metal Single Layer, and Vitrified

Superior performance for grinding non-ferrous materials



## DIAMOND WHEELS

- High quality synthetic diamond
- High material removal rates with longer wheel life vs. conventional green silicon carbide wheels
- Wide variety of stock wheel shapes and bond options available

### Diamond Bond Types

BONDS	DESCRIPTION
<b>Diamond Wheel Bonds</b>	
Pre-engineered resin bond – B99	Free cutting; superior form holding; efficient wet or dry
Premium, heavy-duty resin bond – B105	Ideal for dry toolroom reconditioning applications
Metal bond – M99	Ideal for 1A1R cut-off applications and grinding glass or ceramic materials
MSL (metal single layer) diamond tools; no wheel dressing required	Fast stock removal, cool cutting; excellent for dry offhand finishing of carbide
Vitrified bond – V99	Most durable under high grinding forces; excellent for wet, offhand finishing of carbide tools

Superior performance for grinding ferrous materials



## cBN WHEELS

- cBN (cubic Boron Nitride) abrasive material is second in hardness to diamond
- Easily cuts difficult-to-grind steel parts Rc 50 or harder
- Highly wear resistant and thermally stable

### cBN Bond Types

BONDS	DESCRIPTION
<b>cBN Wheel Bonds</b>	
Pre-engineered resin bond – B99	Free cutting, superior form holding
Premium Aztec III resin bond	Most efficient for dry tool resharpening
Premium Aztec .007 resin bond	Most efficient for dry tool resharpening where heavy stock removal is desired

### How to Select Diamond Wheels

SELECT:	
<b>WHEEL SHAPE</b>	Select desired wheel shape
<b>WHEEL DIMENSIONS</b>	D x T x H Select Diameter x Thickness x Hole from the availability tables. Use blueprint numbers where available.
<b>ABRASIVE</b>	Select the abrasive based on horsepower, grinding wet or dry, and contact with steel.
	<b>Resin Bond Wheels:</b>
	ASD Armored diamond, durable. Versatile: can be used wet or dry. Also should be used when carbide and steel are ground in the same operation.
	D Micron-sized diamond. Used for finishing and polishing operations.
	SD Free cutting standard. Used wet or dry; should be used on low horsepower (3/4 hp or less) machines.
	<b>Metal Bond Wheels:</b>
	M4D Armored, durable standard. A strong, blocky crystal designed for high performance on glass, ceramics, refractories and other non-metals.
	<b>Vitrified Bond Wheels:</b>
	RMD Medium strength. Specifically designed for use with vitrified bonds.
	SD Free cutting standard.
<b>GRIT SIZE</b>	Select the abrasive grit size based on finish and material removal rate required.
	100 Roughing. The most common grit size for roughing operations.
	120 For roughing where 100 is too coarse. Also for cut-off applications.
	150 Medium stock removal plus good finish. For combined roughing and finishing applications.
	180 Medium stock removal plus good finish. To improve finish.
	220 Finishing
	320 Finishing
	400 Fine Finishing
	10/20 Mic Super Fine Finishing
	6/12Mic Super Fine Finishing
<b>GRADE</b>	The hardness of the wheel
	<b>Resin Bond Wheels:</b>
	R Norton standard
	N Free cutting
	<b>Metal Bond Wheels:</b>
	N Norton standard
	<b>Vitrified Bond Wheels:</b>
	P Norton standard
	R Most durable
	<b>CONCENTRATION</b>
50 Most economical. For broad area of contact grinding.	
75 Norton standard. Freer cutting than 100 and the most economical for dry grinding with ASD diamond.	
100 Very durable. Recommended under flood coolant conditions; for use with 220 grit or finer, when durability is required, and for cut-off applications.	
125 Form holding. Used in high volume, high pressure coolant, precision applications on high-speed tool steels.	
<b>BOND</b>	Select the bond based on the material being ground and grinding application.
	<b>Resin Bond:</b>
	B99 Norton standard. Versatile enough to be used wet or dry on most tool making or sharpening applications.
	B105 Premium, heat-reducing bond. For dry toolroom reconditioning applications.
	<b>Metal Bond:</b>
	M99 Best suited for 1A1R cut-off applications as well as grinding glass or ceramic materials.
	MSL Metal Single Layer. Available in shape 6A2C for dry, offhand reconditioning of carbide tools.
	<b>Vitrified Bond:</b>
V99 Best for wet offhand finishing of carbide tools as well as plunge grinding of carbide tools.	
<b>ABRASIVE DEPTH</b>	Usable abrasive
	1/16
	1/8
	1/4
	9/32
	Solid



### How to Select Stock cBN Wheels

SELECT:			
<b>WHEEL SHAPE</b>	Select desired wheel shape		
<b>WHEEL DIMENSIONS</b>		D x T x H	Select Diameter x Thickness x Hole from the availability tables. Use blueprint numbers where available.
<b>ABRASIVE</b>	Select cBN abrasive to grind hard tool steels such as A2, D2, T15, etc., and tough alloy steels.	<b>Resin Bond Wheels:</b> CB	Norton standard coated cBN (cubic Boron Nitride). Optimized for high performance in resin bond systems.
<b>GRIT SIZE</b>	Select the grit size based on finish and material removal rate required.	100 120 150	Roughing. The most common grit size for roughing operations. For roughing where 100 is too coarse. Also for cut-off applications. Medium stock removal plus good finish. For combined roughing and finishing applications.
<b>GRADE</b>	The hardness of the wheel	Q T W	Approximately 50 concentration. Used on wide area of contact applications. Norton standard. Approximately 75 concentration. T is the first choice for lower horsepower equipment or large area of contact between the wheel and the work piece. Ideal for resharpening applications with 11V9, 12A2, 4A2P, and 15V9 wheel shapes when dry grinding. Most durable. Approximately 100 concentration, W is recommended for high volume coolant operations: flute grinding from solid, flute polishing, surface, and cylindrical grinding.
<b>BOND</b>	Select the bond depending on the type of grinding application.	B99 Aztec III Aztec .007	Norton standard. Pre-engineered for optimal performance with cBN abrasive. Available in all shapes. The advanced heat-reducing, lubricating resin bond. Used for dry grinding tool steels. The premium resin bond for increased feed rates, high stock removal and heavier cuts – when dry grinding tool steels.
<b>ABRASIVE DEPTH</b>	Usable abrasive	1/16 1/8 1/4 Solid	

### Competitive Cross Reference Guides

	Abrasives				Bonds						
	Resin Diamond	Resin Diamond	Metal Diamond	Resin/Vitrified cBN	Resin Diamond	Resin Diamond	Metal Diamond	Vitrified Diamond	Resin cBN	Resin cBN	Resin cBN
<b>NORTON WINTER</b>	<b>ASD</b>	<b>SD</b>	<b>M4D</b>	<b>CB</b>	<b>B99/B99E</b>	<b>B105</b>	<b>M99</b>	<b>V99</b>	<b>B99/B99E</b>	<b>B99EF</b>	<b>AZTEC</b>
3M / General Industrial Diamond / Diamond Productions, Inc	CGD, ND	GD, D, MD		CB	PS			V		BC	
Abrasive Technology	SN	S		cBN	B		M		B		
Accurate Diamond Tool	NCD	D, MD		BN	B		M				
Citco	5SD, 6SD	SD	MD	CB	B43, B52		M		B26	C3	
Engis	NMD	D, MD		cBN, CB							
Noritake				CBC		BX4			BD/B38		BX4
Radiac / US Diamond	NCD, WD, 1WD, MDC	D, MD	MD4C	B, CB, BZ	B7Z, BB, B5, B56, BN		M, MF	V	BZ, BN		
Regal Diamond				B, BB	BJ						
Superabrasives, Inc.	MDN	D, MD		B					B82	B5	
Tyrolit / Wickman / Bay State / Cincinnati	SDM, XDL, XDN, D, 7D, CMD	SD, D, 6D, MD	1D	5B, 1BN, BN, BM	BD, BC, BX33, B52, B6	Amigo	MI, MSS, MB		B72, B56, BG, B7	BXU8	Amigo
Wendt / Slip Naxos / Winterthur	SDK			B, BXW					RN	RR	
<b>NORTON WINTER POLYIMIDE</b>	<b>ABRASIVES UNIVEL/G-FORCE DIAMOND AD</b>			<b>cBN BX</b>	<b>BONDS DIAMOND AND cBN UNIVEL G-FORCE</b>						
3M / General Industrial Diamond / Diamond Productions, Inc	D			CB	BP		BPP				
Citco	SD			CB	P		C5				

### TECH TIP

- Truing makes the wheel concentric with the spindle
- Dressing opens the wheel's cutting face
- Always true and dress diamond and cBN wheels prior to use
- Diamond and cBN wheels with grit sizes 100 – 180 can be trued with a Brake Controlled Truing Device
- Refer to the "Mounting, Truing and Dressing Guide" for more information



It is the user's responsibility to refer to and comply with ANSI B7.1

### TECH TIP

#### Diamond Grinds:

In general, diamond is used to grind non-ferrous materials, because of an adverse reaction between diamond and iron.

- Cemented carbide
- Glass
- Ceramics
- Fiberglass
- Plastics
- Stone
- Abrasives
- Electronic components and materials

#### cBN Grinds:

cBN is used to grind ferrous materials.

- High-speed tool steels
- Die steels
- Hardened carbon steels
- Alloy steels
- Aerospace alloys
- Hardened stainless steel
- Abrasion-resistant ferrous materials



It is the user's responsibility to refer to and comply with ANSI B7.1



### B99 Express Service

The B99 Express service is designed to offer you up to 65,000 made-to-order choices of resin bond Diamond and cBN wheels. Almost all popular sizes are offered.

12" and less diameter B99 Express wheels will ship in two weeks or less from the date the order is received. 14" and larger wheels are available at standard lead-times.

**Our Norton Winter line offers a comprehensive stock product selection to service most of your needs – with the fastest delivery and lowest total costs.**

Review this stock section first. If you can not find the specification you need:

- Then refer to the brief descriptions of our B99 Express and CNC lines (following this section)
- See the more in-depth B99 Express product availability in our "Diamond and cBN Superabrasives Standard Catalog" #8068 on [www.nortonabrasives.com](http://www.nortonabrasives.com) or contact your Norton representative for a complete listing of made-to-order superabrasive products.

**Type DW**

- D - Diameter
- T - Thickness
- Y - Spindle Diameter
- SP - Spindle Length

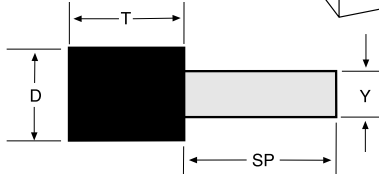

**Type HH1**

- L - Length
- L1 - Length of Abrasive
- X - Abrasive Depth
- W - Width
- T - Thickness (Back)

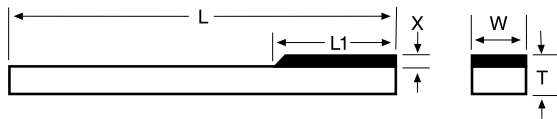

**Type HH2**

- L - Length
- L1 - Length of Abrasive
- X - Abrasive Depth
- W - Width
- T - Thickness (Back)

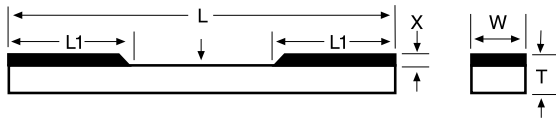

**Type 1A1**

- D - Diameter
- X - Abrasive Depth
- H - Hole
- T - Thickness

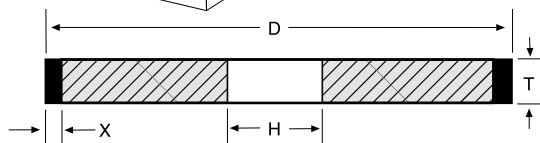

**Type 1A1R**

- D - Diameter
- X - Abrasive Depth
- H - Hole
- E - Back Thickness
- T - Thickness

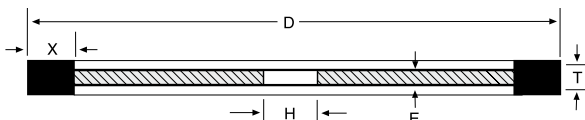

SIZE (D x T)	SPECIFICATION	PART #
<b>Type DW Mounted Points - Diamond</b>		
3/16 x 1/4	SD100-R100B99-SOLID	690141 <b>92238</b>
Steel Spindle 1/8 x 1-1/2		
1/2 x 1/2	SD220-R100B99-SOLID	690141 <b>92249</b>
Steel Spindle 1/4 x 1-1/2		
3/4 x 3/8	SD150-R100B99-SOLID	690141 <b>92251</b>
Steel Spindle 1/4 x 1-1/2		
1 x 1/2	SD100-R100B99-SOLID	690141 <b>92428</b>
Steel Spindle 1/4 x 1-1/2		
<b>Type DW Mounted Points - cBN</b>		
3/16 x 1/4	CB150-WB99-SOLID	690141 <b>92258</b>
Carbide Spindle .125 x 1-3/4		
SIZE (T x W x L)	SPECIFICATION	PART #
<b>Type HH1 Hand Hones - Diamond</b>		
1/4 x 1/4 x 6	ASD220-R100B99-1/16	690141 <b>92139</b>
One 1/16 deep 1" long insert in one 1/4 surface		
1/4 x 3/8 x 4	ASD100-R100B99-1/16	690141 <b>92141</b>
One 1/16 deep 1" long insert in one 3/8 surface	ASD180-R100B99-1/16	690141 <b>92142</b>
	ASD220-R100B99-1/16	690141 <b>91670</b>
	ASD320-R100B99-1/16	690141 <b>91672</b>
	ASD400-R100B99-1/16	690141 <b>92143</b>
	D10/20MIC-R100B99-1/16	690141 <b>92144</b>
	SD320-100V99-1/16	690141 <b>92140</b>
<b>Type HH2 Hand Hones - Diamond</b>		
1/4 x 3/8 x 4	ASD120/220-R100B99-1/16	690141 <b>92150</b>
Two 1/16 deep 1" long inserts in one 3/8 surface	ASD220/320-R100B99-1/16	690141 <b>92178</b>
	ASD220/400-R100B99-1/16	690141 <b>92179</b>
	ASD320/400-R100B99-1/16	690141 <b>92180</b>
	SD220/320-100V99-1/16	690141 <b>92149</b>
SIZE (D x T x H)	SPECIFICATION	PART #
<b>Type 1A1 Straight - Diamond</b>		
1 x 1/4 x 1/4	SD100-R100B99-1/8	690141 <b>92175</b>
1-1/2 x 1/2 x 1/2	D6/12MIC-N100B99-1/8	690141 <b>92176</b>
2 x 1/8 x 1/4	SD100-R100B99-1/8	690141 <b>92184</b>
3 x 1/4 x 3/4	SD180-N100B99-1/8	690141 <b>92187</b>
4 x .020 x 1-1/4	SD320-R100B99-1/8	690141 <b>92188</b>
4 x 1/32 x 1-1/4	SD100S-R100B99-1/4	690141 <b>92192</b>
4 x 1/16 x 1-1/4	SD100S-R100B99-1/4	662602 <b>73583</b>
	SD150-R100B99-1/4	662602 <b>73584</b>
	SD220-R100B99-1/4	662602 <b>73586</b>
4 x 1/8 x 3/4	SD150-R100B99-1/4	690141 <b>92024</b>
4 x 1/8 x 1-1/4	SD150-R100B99-1/4	690141 <b>91677</b>
4 x 1/4 x 1/2	SD150-R100B99-1/4	662602 <b>73590</b>
4 x 1/4 x 3/4	SD150-R100B99-1/4	662602 <b>73592</b>
4 x 1/4 x 1-1/4	SD100S-R100B99-1/4	662602 <b>73587</b>
	SD120-R100B99-1/4	662602 <b>73588</b>
	SD150-R100B99-1/4	662602 <b>73589</b>
4 x 1/2 x 1-1/4	SD150-R100B99-1/4	662602 <b>73594</b>
6 x 1/32 x 1-1/4	SD220-R100B99-1/8	690141 <b>92197</b>
6 x 1/16 x 1-1/4	SD100-R100B99-1/4	662602 <b>73596</b>
	SD150-R100B99-1/4	662602 <b>73597</b>
	SD180-R100B99-1/4	662602 <b>73598</b>
	SD220-R100B99-1/4	662602 <b>73599</b>
6 x 1/8 x 1-1/4	ASD150-R75B99-1/4	662602 <b>73617</b>
	SD100-R100B99-1/4	662602 <b>73611</b>
	SD150-R100B99-1/4	662602 <b>73613</b>
	SD180-R100B99-1/4	662602 <b>73614</b>
	SD220-R100B99-1/4	662602 <b>73615</b>
6 x 1/4 x 1-1/4	ASD100S-R75B99-1/4	690141 <b>92205</b>
	ASD120-R75B99-1/4	690141 <b>92769</b>
	ASD150-R75B99-1/4	662602 <b>73609</b>
	ASD180-R75B99-1/4	690141 <b>92770</b>
	ASD220-R75B99-1/4	690141 <b>92771</b>
	ASD320-R75B99-1/4	690141 <b>92772</b>
	RMD180-P100V99-1/8	690141 <b>92203</b>
	SD120-R100B99-1/4	690141 <b>91691</b>
	SD150-R100B99-1/4	690141 <b>91692</b>
	SD180-R100B99-1/4	690141 <b>91693</b>
	SD220-R100B99-1/4	690141 <b>92764</b>

Standard Package = 1 mounted point, hand hone, or wheel  
Continued

SIZE (D x T x H)	SPECIFICATION	PART #
<b>Type 1A1 Straight – Diamond continued</b>		
6 x 3/8 x 1-1/4	ASD120-R75B99-1/4	690141 <b>92773</b>
	ASD150-R75B99-1/4	690141 <b>91695</b>
	SD150-R100B99-1/4	690141 <b>91696</b>
6 x 1/2 x 1-1/4	ASD120-R75B99-1/4	690141 <b>92777</b>
	ASD150-R75B99-1/4	690141 <b>91698</b>
	ASD220-R75B99-1/4	690141 <b>92779</b>
	ASD320-R75B99-1/4	690141 <b>92780</b>
	SD120-R100B99-1/4	662602 <b>73557</b>
	SD150-R100B99-1/4	662602 <b>73561</b>
7 x 1/4 x 1-1/4	SD180-R100B99-1/4	690141 <b>91700</b>
	ASD150-R75B99-1/4	690141 <b>91701</b>
	SD100S-R100B99-1/4	690141 <b>92210</b>
	SD120-R100B99-1/4	662602 <b>73566</b>
	SD150-R100B99-1/4	690141 <b>91703</b>
	SD180-R100B99-1/4	690141 <b>91704</b>
7 x 3/8 x 1-1/4	SD220-R100B99-1/4	690141 <b>91705</b>
	SD120-R100B99-1/4	690141 <b>91849</b>
	SD220-R100B99-1/4	690141 <b>91852</b>
7 x 1/2 x 1-1/4	ASD100-R75B99-1/4	690141 <b>92211</b>
	ASD150-R75B99-1/4	690141 <b>91853</b>
	ASD180-R75B99-1/4	690141 <b>92212</b>
	SD120-R100B99-1/4	690141 <b>91854</b>
	SD150-R100B99-1/4	690141 <b>91855</b>
	SD180-R100B99-1/4	690141 <b>91856</b>
8 x 1/2 x 1-1/4	SD220-R100B99-1/4	690141 <b>91857</b>
	SD150-R100B99-1/4	662602 <b>73574</b>
	ASD120-R75B99-1/4	690141 <b>92305</b>
10 x 1/2 x 3	ASD180-R100B99-1/4	690141 <b>92306</b>
	ASD150-R75B99-1/4	690141 <b>92310</b>
	ASD150-R75B99-1/4	690141 <b>92311</b>
12 x 1/2 x 3	ASD120-R75B99-1/4	690141 <b>92312</b>
12 x 1 x 3	ASD120-R75B99-1/4	690141 <b>92313</b>
12 x 1 x 5	ASD150-R75B99-1/4	690141 <b>92314</b>
14 x 1/2 x 5	ASD120-R75B99-1/4	690141 <b>92316</b>
14 x 1 x 5	ASD120-R75B99-1/4	690141 <b>92325</b>
20 x 1 x 12	ASD120-R75B99-1/4	690141 <b>92325</b>

Standard Package = 1 wheel

SIZE (D x T x H)	SPECIFICATION	PART #
<b>Type 1A1 Straight – cBN</b>		
6 x 1/8 x 1-1/4	CB120-TB99-1/4	662602 <b>73601</b>
6 x 1/4 x 1-1/4	CB120-TB99-1/4	662602 <b>73605</b>
6 x 1/2 x 1-1/4	CB120-TB99-1/4	662602 <b>73607</b>
7 x 1/4 x 1-1/4	CB120-TB99-1/4	690141 <b>92021</b>
7 x 1/2 x 1-1/4	CB120-TB99-1/4	662602 <b>73567</b>
12 x 1/2 x 5	CB150-TB99-1/4	662602 <b>73560</b>
12 x 1 x 5	CB150-TB99-1/4	662602 <b>73562</b>
<b>Type 1A1R Cut-Off – Diamond</b>		
3 x .020 x 1/2 (ME104177)	M4D150-N50M99-1/8	690141 <b>92060</b>
4 x .012 x 1/2 (ME104180)	M4D180-N75M99-1/8	690141 <b>92063</b>
4 x .020 x 1/2 (ME104180)	M4D220-N75M99-1/8	690141 <b>92064</b>
4 x .030 x 1/2 (ME104180)	M4D220-N100M99-1/8	690141 <b>92067</b>
4 x .030 x 1/2 (ME104180)	M4D150-N75M99-1/8	690141 <b>92068</b>
4 x 1/32 x 3/4 (ME43570)	SD100S-R100B99-1/4	690141 <b>92151</b>
4 x 1/32 x 1-1/4 (ME43570)	SD120-R100B99-1/4	690141 <b>91706</b>
5 x .015 x 1/2 (ME104180)	SD100S-R100B99-1/4	690141 <b>92152</b>
6 x .017 x 1-1/4 (ME104180)	M4D220-N100M99-1/8	690141 <b>92070</b>
6 x .025 x 1-1/4 (ME104180)	M4D150-N100M99-1/8	690141 <b>92082</b>
6 x .035 x 5/8 (ME104177)	M4D220-N100M99-1/8	690141 <b>92083</b>
6 x .035 x 1-1/4 (ME43572)	M4D150-N100M99-1/8	690141 <b>92086</b>
	SD100-R75B99-1/4	690141 <b>92155</b>
	ASD100S-R100B99-1/4	690141 <b>92158</b>
	ASD120-R100B99-1/4	690141 <b>92159</b>
	SD100-R100B99-1/4	690141 <b>91858</b>
	SD100S-R100B99-1/4	690141 <b>92156</b>
	SD220-R100B99-1/4	690141 <b>92157</b>

Continued

## TECH TIP

### Cylindrical Grinding Applications – 1A1 wheels:

- Includes all outside grinding of round parts, even though the finished product is not always a true cylinder
- Infeed at both ends of the traverse to keep wheel face flat
- Use work supports to prevent deflection
- Rough grinding traverse speed should be 1/2 to 2/3 of the thickness of the wheel per work revolution
- Finishing grinding traverse speed should be 1/2" or less per work revolution

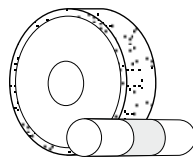

It is the user's responsibility to refer to and comply with ANSI B7.1

## TECH TIP

### Cut-off Applications – 1A1R wheels:

- Use the largest diameter flanges possible
- Use flanges of equal diameter
- Use the thickest wheel possible for increased stiffness and straightness of cut

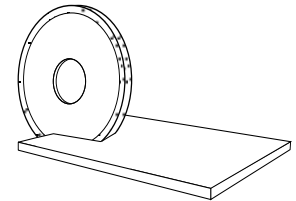

cBN wheels are used on hardened steels.

Diamond wheels are used to cut or slot carbide, glass or ceramic parts.



It is the user's responsibility to refer to and comply with ANSI B7.1

## TECH TIP

### Diamond Grinds:

- Cemented carbide
- Glass
- Ceramics
- Fiberglass
- Plastics
- Stone
- Abrasives
- Electronic components and materials

### cBN Grinds:

- High-speed tool steels
- Die steels
- Hardened carbon steels
- Alloy steels
- Aerospace alloys
- Hard stainless steel
- Abrasion-resistant ferrous materials

## Can't Find Your Specification Here?

Review this stock section first. If you can not find the specification you need:

- Then refer to the brief descriptions of our B99 Express and CNC lines (following this section)
- See the more in-depth B99 Express product availability in our "Diamond and cBN Superabrasives Standard Catalog" #8068 on [www.nortonabrasives.com](http://www.nortonabrasives.com) or contact your Norton representative for a complete listing of made-to-order superabrasive products.

SIZE (D x T x H)	SPECIFICATION	PART #
<b>Type 1A1R Cut-Off – Diamond</b>		
6 x .035 x 1-1/4 (ME73316)	ASD100S-R100B99-9/32	690141 <b>92164</b>
	ASD120-R100B99-9/32	690141 <b>92165</b>
	SD100-R100B99-9/32	690141 <b>92161</b>
	SD120-R100B99-9/32	690141 <b>92162</b>
	SD150-R100B99-9/32	690141 <b>92163</b>
	SD100-R50B99-1/8	690141 <b>92166</b>
6 x .045 x 1-1/4 (ME83991)		
6 x .055 x 1-1/4 (ME104177)	M4D100-N75M99-1/8	690141 <b>92099</b>
7 x .035 x 1-1/4 (ME82347)	ASD100-R100B99-1/4	662602 <b>38686</b>
7 x .055 x 1-1/4 (ME104177)	M4D120-N100M99-1/8	690141 <b>92108</b>
8 x .030 x 1-1/4 (ME104180)	M4D180-N75M99-1/8	690141 <b>92110</b>
8 x .045 x 5/8 (ME43569)	SD120-R100B99-1/4	690141 <b>92167</b>
8 x .045 x 1-1/4 (ME43569)	SD120-R100B99-1/4	690141 <b>92169</b>
8 x .050 x 1-1/4 (ME104180)	M4D180-N75M99-1/8	690141 <b>92114</b>
10 x .050 x 1-1/4 (ME 43565)	ASD120-R100B99-1/4	662602 <b>30236</b>
	CD100-R100B99-1/4	690141 <b>92815</b>
	SD120-R100B99-1/4	690141 <b>92170</b>
12 x .070 x 3/4 (ME 43567)	SD150-R100B99-1/4	690141 <b>92173</b>
<b>Type 1A1R Cut-off – cBN</b>		
6 x .035 x 1-1/4 (ME43572)	CB100-WB99-1/4	690141 <b>92160</b>
<b>Type 1V1P Fluting – Diamond</b>		
6 x 3/32 x 1-1/4	ASDC320C-R100B99-1/4	690141 <b>92761</b>
Face Bevel 1 Side 20 Deg	ASD320B-R125B99-1/4	690141 <b>92302</b>
Copper Core (ME89562)		
<b>Type 4A2P Dish – Diamond</b>		
6 x 3/8 x 1-1/4	ASD120-R75B99-1/16	690141 <b>92280</b>
Rim Width 1/4"		
(ME88369)		

Standard Package = 1 wheel

Refer to "Brake Controlled Truing Devices" and "Dressing Sticks" in the Dressing Solutions section for truing and dressing products.

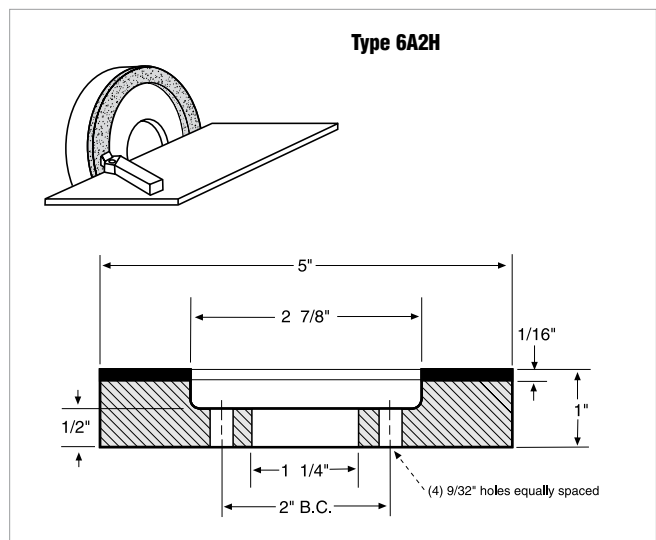
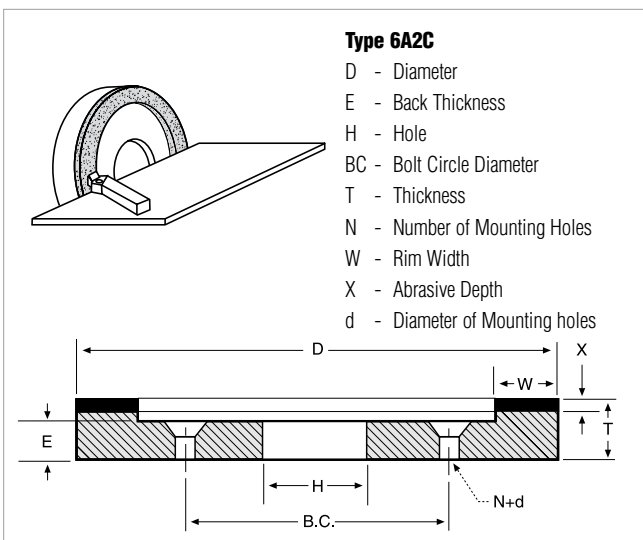
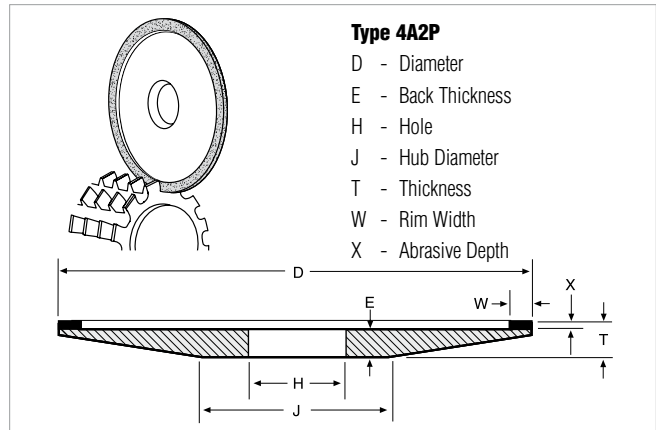
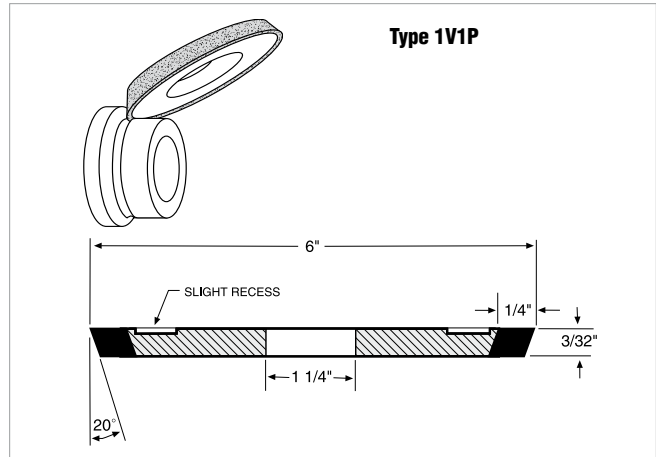
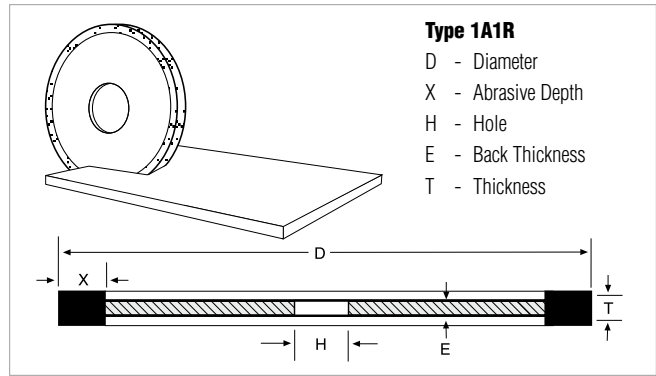

SIZE (D x T x H)	SPECIFICATION	PART #
<b>Type 6A2C Straight cup – Diamond</b>		
6 x 7/16 x 1-1/4 Rim Width 1" (0640185M)	D120/140-H-MSL	662602 <b>69172</b>
6 x 3/4 x 1-1/4 Rim Width 3/4" (ME27853)	SD220-R50B99-1/16	690141 <b>91665</b>
	ASD120-R75B99-1/16	690141 <b>91860</b>
	ASD120-R75B99-1/8	690141 <b>92786</b>
	SD150-P50V99-1/16	690141 <b>92217</b>
6 x 3/4 x 1-1/4 Rim Width 1/2" (ME30621)	SD220-P50V99-1/8	690141 <b>91623</b>
	ASD120-R75B99-1/8	662602 <b>73565</b>

Standard Package = 1 wheel

SIZE (D x T x H)	SPECIFICATION	PART #
<b>Type 6A2H Straight Cup – Diamond</b>		
5 x 1 x 1-1/4 Rim Width 1-1/16" (ME27084)	SD320-R50B99-1/16	690141 <b>92221</b>

Standard Package = 1 wheel

Best choice for dry grinding carbide tools

## ASD DIAMOND / B105 RESIN BOND WHEELS

- Premium quality diamond produces keen cutting tools that hold their shape, are easier to sharpen, and require fewer reconditionings
- Advanced, self lubricating bond minimizes heat generation and thermal damage to tool for increases tool life and productivity; lasts more than 2X as long as standard diamond wheels for lowest total wheel costs and highest productivity
- Unique self-dressing core eliminates wheel core damage and downtime to dress core

TIER: **BEST**  
BOND: **B105**

SIZE (D x T x H)	SPECIFICATION	PART #
<b>Type 11V9 Flaring Cup – Diamond</b>		
3-3/4 x 1-1/2 x 1-1/4 Insert Length 3/8" (ME92192)	ASD120-R75B105-1/16	690141 <b>91905</b>
	ASD150-R75B105-1/16	690141 <b>91906</b>
	ASD100S-R75B105-1/8	690141 <b>91908</b>
	ASD120-R75B105-1/8	690141 <b>91909</b>
5 x 1-3/4 x 1-1/4 Insert Length 7/16" (ME98298)	ASD150-R75B105-1/8	690141 <b>91910</b>
	ASD120-R75B105-1/16	690141 <b>91913</b>
	ASD150-R75B105-1/16	690141 <b>91914</b>
	ASD100S-R75B105-1/8	690141 <b>91916</b>
	ASD150-R75B105-1/8	690141 <b>91918</b>

TIER: **BETTER**  
BOND: **B99**

SIZE (D x T x H)	SPECIFICATION	PART #
<b>Type 11V9 Flaring Cup – Diamond</b>		
3 x 1-1/4 x 3/4 Insert Length 3/8" (ME93912)	ASD120-R75B99-1/16	690141 <b>92291</b>
	ASD150-R75B99-1/16	690141 <b>92292</b>
	SD150-R100B99-1/16	690141 <b>92293</b>
	ASD120-R75B99-1/16	690141 <b>92022</b>
3-3/4 x 1-1/2 x 3/4 Insert Length 3/8" (M92192)		
3-3/4 x 1-1/2 x 1-1/4 Insert Length 3/8" (ME92192)	ASD150C-R50B99-1/8	690141 <b>90751</b>
	ASD120-R75B99-1/16	690141 <b>91660</b>
5 x 1-3/4 x 1-1/4 Insert Length 7/16" (ME98298)	ASD150-R75B99-1/16	690141 <b>91725</b>
	ASD100S-R75B99-1/8	690141 <b>91653</b>
	ASD120-R75B99-1/8	690141 <b>91652</b>
	ASD150-R75B99-1/8	690141 <b>91651</b>
	ASD180-R75B99-1/8	690141 <b>91650</b>
	SD120-R100B99-1/16	690141 <b>91657</b>
	SD150-R100B99-1/16	690141 <b>91656</b>
	SD220-R100B99-1/16	690141 <b>91654</b>
	SD320-R100B99-1/16	690141 <b>92814</b>
	SD100S-R100B99-1/8	690141 <b>92427</b>
	SD120-R100B99-1/8	690141 <b>91649</b>
	SD150-R100B99-1/8	690141 <b>91648</b>
	SD180-R100B99-1/8	690141 <b>91647</b>
	SD220-R100B99-1/8	690141 <b>91646</b>
	ASD100S-R75B99-1/16	690141 <b>91645</b>
	ASD120-R75B99-1/16	690141 <b>91644</b>
	ASD150-R75B99-1/16	690141 <b>91643</b>
	ASD100S-R75B99-1/8	690141 <b>91637</b>
	ASD120-R75B99-1/8	690141 <b>91636</b>
	ASD150-R75B99-1/8	690141 <b>91635</b>
	ASD180-R75B99-1/8	690141 <b>91634</b>
	SD120-R100B99-1/16	690141 <b>91641</b>
	SD150-R100B99-1/16	690141 <b>91640</b>
	SD220-R100B99-1/16	690141 <b>91638</b>
	SD150-R100B99-1/8	690141 <b>91632</b>
	SD180-R100B99-1/8	690141 <b>91631</b>

Standard Package = 1 Wheel

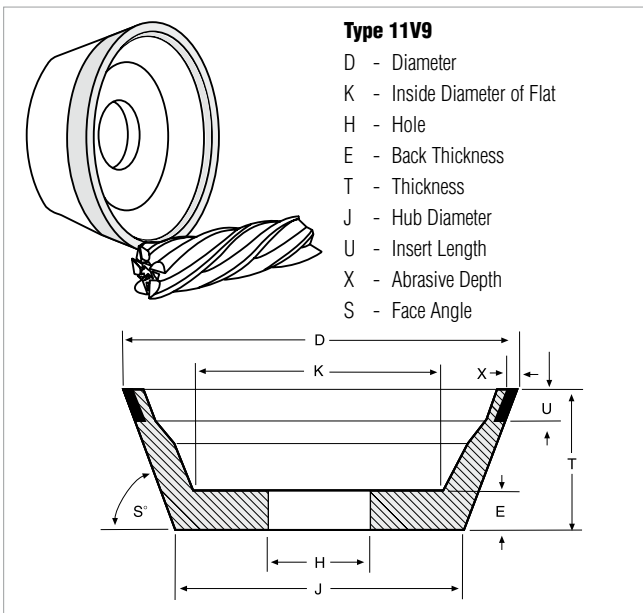

Best choice for dry tool sharpening

## AZTEC cBN WHEELS

- Consistent, high quality cBN (cubic Boron Nitride) abrasive which offers 85% longer life than standard cBN wheels
- Advanced heat-reducing bond conducts heat away from the workpiece for freer cutting action and extended wheel life; helps maintains cutting tool steel integrity and extends tool life
- AZTEC III lubricating bond eliminates steel braze and loading; AZTEC .007 allows increased infeed (start at .007) for high stock removal

TIER: <b>BEST</b>		
BOND: <b>AZTEC</b>		
SIZE (D x T x H)	SPECIFICATION	PART #
<b>Type 11V9 Flaring Cup – cBN</b>		
3-3/4 x 1-1/2 x 1-1/4 Insert Length 3/8" (ME92192)	AZTEC .007-100-1/16	690141 <b>95683</b>
	AZTEC .007-150-1/16	690141 <b>95679</b>
	AZTEC III 100T-1/16	690141 <b>91832</b>
	AZTEC III 120T-1/16	690141 <b>91833</b>
	AZTEC III 150T-1/16	690141 <b>91834</b>
	AZTEC III 100T-1/8	690141 <b>91838</b>
5 x 1-3/4 x 1-1/4 Insert Length 7/16" (ME98298)	AZTEC III 120T-1/8	690141 <b>91839</b>
	AZTEC III 150T-1/8	690141 <b>91840</b>
	AZTEC .007-100-1/16	690141 <b>95685</b>
	AZTEC III 100T-1/16	690141 <b>91841</b>
	AZTEC III 120T-1/16	690141 <b>91842</b>
	AZTEC III 150T-1/16	690141 <b>91843</b>
	AZTEC .007-100-1/8	690141 <b>95686</b>
	AZTEC .007-150-1/8	690141 <b>95682</b>
	AZTEC III 100T-1/8	690141 <b>91844</b>

Standard Package = 1 Wheel

TIER: <b>BETTER</b>		
BOND: <b>B99</b>		
SIZE (D x T x H)	SPECIFICATION	PART #
<b>Type 11V9 Flaring Cup – cBN</b>		
3-3/4 x 1-1/2 x 1-1/4 Insert Length 3/8" (ME92192)	CB100-TB99-1/16	690141 <b>91719</b>
	CB100-TB99-1/8	690141 <b>91722</b>
	CB120-TB99-1/8	690141 <b>91723</b>
	CB150-TB99-1/8	690141 <b>91724</b>
	CB120-WB99-1/16	690141 <b>91720</b>
5 x 1-3/4 x 1-1/4 Insert Length 7/16" (ME98298)	CB120-TB99-1/8	690141 <b>91715</b>
	CB150-TB99-1/8	690141 <b>91716</b>

Standard Package – 1 Wheel

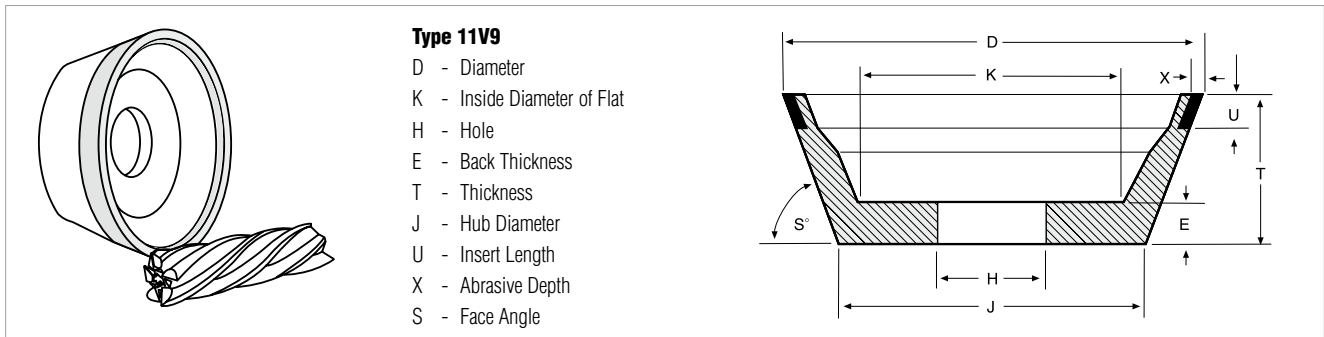

Refer to “Brake Controlled Truing Devices” and “Dressing Sticks” in the Dressing Solutions section for truing and dressing products.

TIER: **BETTER**  
BOND: **B99**

SIZE (D x T x H)	SPECIFICATION	PART #
<b>Type 12A2 Dish – Diamond</b>		
4 x 1/2 x 1-1/4 Rim Width 1/4" (ME40745)	SD180-R75B99-1/8	690141 <b>92223</b>
6 x 1 x 1-1/4 Rim Width 3/16" (ME27758)	ASD120-R75B99-1/8 ASD180-R75B99-1/8	690141 <b>91630</b> 690141 <b>92226</b>
<b>Type 12A2 Dish – cBN</b>		
6 x 1 x 1-1/4 Rim Width 3/16" (ME27758)	CB120-TB99-1/16	690141 <b>92227</b>
<b>Type 12V9 Dish – Diamond</b>		
3 x 7/16 x 3/4 Insert Length 7/16" (ME41755)	SD150-R100B99-1/16	690141 <b>92228</b>
4 x 1/2 x 1-1/4 Insert Length 1/4" (ME58734)	SD180-R100B99-1/8	690141 <b>91629</b>
6 x 3/4 x 1-1/4 Insert Length 3/8" (ME48666)	ASD150-R75B99-1/16	690141 <b>91628</b>
<b>Type 12V9 Dish – cBN</b>		
4 x 1/2 x 1-1/4 Insert Length 1/4" (ME58734)	CB120-TB99-1/8	690141 <b>92229</b>
6 x 3/4 x 1-1/4 Insert Length 3/8" (ME48666)	CB120-TB99-1/8 CB150-TB99-1/8	690141 <b>92020</b> 690141 <b>92784</b>
<b>Type 15V9 Dish – Diamond</b>		
6 x 3/4 x 1-1/4 Insert Length 3/8"	SD150-R100B99-1/16	690141 <b>92230</b>

Standard Package = 1 wheel

### Can't Find Your Specification Here?

We offer a comprehensive stock product selection to service most of your needs

– with the fastest delivery and lowest total cost.

Review this stock section first. If you can not find the specification you need:

- Then refer to the brief descriptions of our B99 Express and CNC lines (following this section)
- See the more in-depth B99 Express product availability in our "Diamond and cBN Superabrasives Standard Catalog" #8068 on [www.nortonabrasives.com](http://www.nortonabrasives.com) or contact your Norton representative for a complete listing of made-to-order superabrasive products.

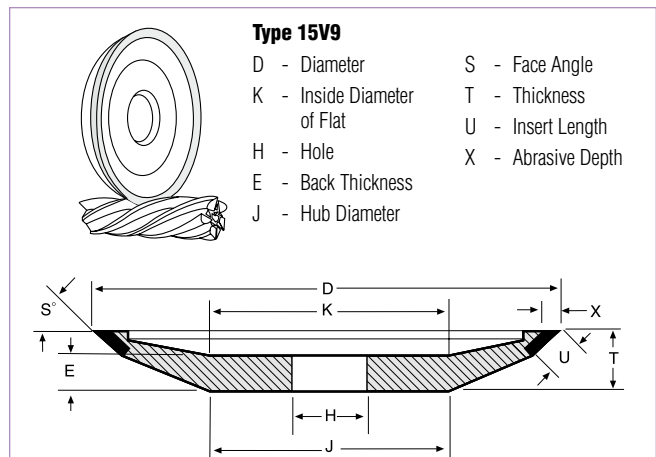
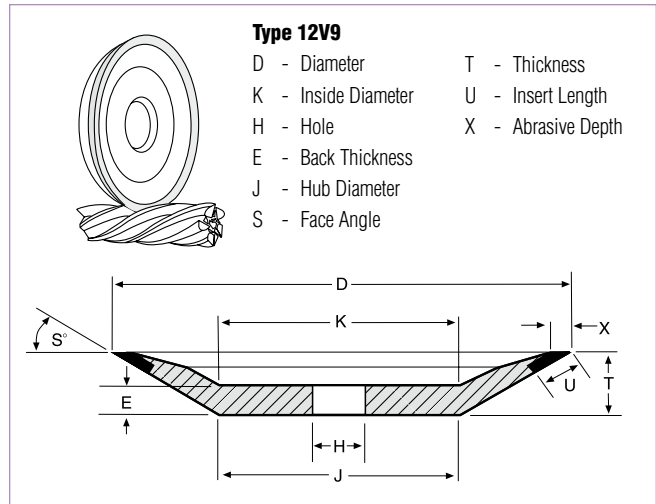
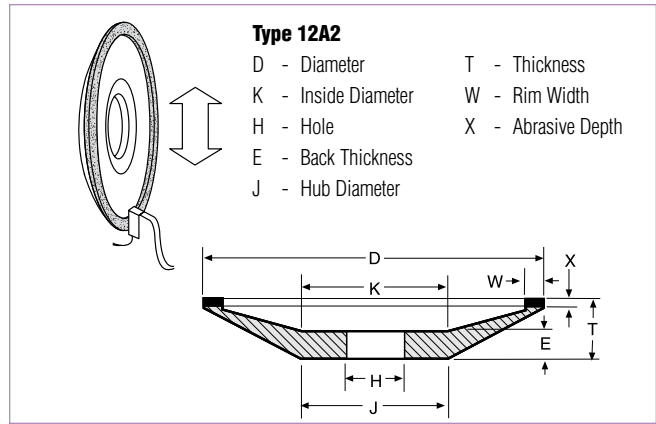



## B99 Express Resin Bond Wheels



65,000+ made-to-order resin products; 25 wheel shapes, with one- and two-week lead-times for 12" and less diameter wheels. 14" and larger wheels and 80 grit and coarser wheels are available with standard made-to-order lead-times. If you do not find the resin specification and/or shape you need in our stock offering, you will most likely find it in our B99 Express made-to-order offering.

**Applications:**

- B99E Diamond Wheels
  - Sharpening cemented carbide cutting tools
  - Cutting-off carbide rod
  - Grinding or cutting-off non-metallic materials such as ceramics or glass
  - Surface grinding dies
  - O.D. grinding spray coatings
- B99E cBN Wheels
  - Sharpening high-speed (M2, D2, T15, etc.) steel cutting tools
  - Surface and ID grinding hardened steel die components
  - Precision grinding steel parts Rc 50 or harder

Superior performing diamond and cBN wheels custom made to your requirements

### B99 EXPRESS MADE-TO-ORDER DIAMOND AND cBN RESIN BOND WHEELS

- Superior diamond or cBN abrasives with durable resin bond systems
- With thousands of abrasive, grit, grade, concentration, and bond combinations there is a B99 Express wheel for almost every resin bond application
- Offering exceptional quality and performance, these wheels are made in our state-of-the-art, USA, ISO-certified facilities; excellent performance/price ratio with convenient two-week (or less) lead-times

#### How to Select B99 Express Made-to-Order Diamond Wheels

**SELECT:**

<b>WHEEL SHAPE</b>	Select desired wheel shape		
<b>WHEEL DIMENSIONS</b>		D x T x H	Select Diameter x Thickness x Hole from the availability tables in Catalog #8068. Use blueprint numbers where available.
<b>ABRASIVE</b>	Select the abrasive based on horsepower, grinding wet or dry, and contact with steel.	ASD	Armored diamond; most durable. Versatile: can be used wet or dry. ASD should be used when carbide and steel are ground in the same operation.
		SD	Free cutting standard. Can be used wet or dry; should be used on low horsepower (3/4 hp or less) machines.
<b>GRIT SIZE</b>	Select the grit size based on finish and material removal rate required.  Note: Standard made-to-order lead-times apply to 80 grit and coarser wheels.	80	Roughing
		100	Roughing. The most common grit size for roughing operations.
		120	For roughing where 100 is too coarse. Also for cut-off applications.
		150	Medium stock removal plus good finish. For combined roughing and finishing applications.
		180	Medium stock removal plus good finish. To improve finish.
		220	Finishing
		320	Finishing
<b>GRADE</b>	The hardness of the wheel	R	Resin bond standard
		<b>CONCENTRATION</b>	Select the concentration based on grinding wet or dry, material removal rates, and form holding requirements.
		50	Shape 2A2T only. For broad area of contact grinding.
		75	Norton standard. Freer cutting than 100 grit and the most economical for dry grinding with ASD diamond.
<b>BOND</b>	Select the bond based on the material being ground and grinding application.	100	Very durable. Recommended under flood coolant conditions. For use with 220 grit or finer, when durability is required. Also for cut-off applications.
		125	Improved form holding. Used with B99EF bond only for form holding in high-volume, high-pressure coolant applications. Used with ASD abrasive.
		B99E	Norton standard pre-engineered resin bond. Versatile enough to be used wet or dry on most tool making or resharpening applications as well as for grinding non-metallic materials such as ceramics or glass. Available in all shapes.
<b>ABRASIVE DEPTH</b>	Usable abrasive	B99EF	Improved form holding. More durable than B99E. Improved heat dissipation in wet or dry applications. Available in wheel shapes 1V1, 1B1, 1E1, 1EE1, 1F1 and 1FF1.
		1/16	
		1/8	
		1/4	
		1/2	

### How to Select B99 Express Made-to-Order cBN Wheels

SELECT:			
<b>WHEEL SHAPE</b>	Select desired wheel shape		
<b>WHEEL DIMENSIONS</b>	Note: Standard made-to-order lead-times apply to 14" and larger wheels.	D x T x H	Select Diameter x Thickness x Hole from the availability tables. Use blueprint numbers where available.
<b>ABRASIVE</b>	Select cBN abrasive to grind hard tool steels such as A2, D2, T15, etc., and tough alloy steels.	CB	Norton standard coated cBN (cubic Boron Nitride). Optimized for high performance in resin bond systems.
<b>GRIT SIZE</b>	Select the grit size based on finish and material removal rate required.  Note: Standard made-to-order lead-times apply to 80 grit and coarser wheels.	100	Roughing. The most common grit size for roughing operations.
		120	For roughing where 100 is too coarse. Also for cut-off applications.
		150	Medium stock removal plus good finish. For combined roughing and finishing applications.
		180	Medium stock removal plus good finish. To improve finish.
		220	Finishing
		320	Finishing
<b>GRADE</b>	The hardness of the wheel	T	Norton standard. Approximately 75 concentration, T is the first choice for lower horsepower equipment or wide area of contact between the wheel and the workpiece. Ideal for resharpening applications with 11V9, 12A2, 4A2P, and 15V9 wheel shapes when dry grinding.
		W	Very durable. Approximately 100 concentration, W is recommended for high volume coolant operations: flute grinding from solid, flute polishing, surface, and cylindrical grinding.
		Z	Form holding. Approximately 125 concentration, Z grade is extremely durable and is recommended where long life or form holding is required in high-volume, high-pressure coolant applications. Used with B99EF bond only.
<b>BOND</b>	Select the bond depending on the type of grinding application.	B99E	Norton standard resin bond. Pre-engineered for optimal performance with cBN abrasive. Available in all shapes.
		B99EF	Improved form holding. More durable than B99E. Improved heat dissipation in wet or dry applications. Available in wheel shapes 1V1, 1B1, 1E1, 1EE1, 1F1 and 1FF1.
<b>ABRASIVE DEPTH</b>	Usable abrasive	1/16	
		1/8	
		1/4	
		1/2	

See the more in-depth B99 Express product availability in our "Diamond and cBN Superabrasives Standard Catalog" #8068 on [www.nortonabrasives.com](http://www.nortonabrasives.com) or contact your Norton representative for a complete listing of made-to-order superabrasive products.

### TECH TIP

#### Diamond Grinds:

In general, diamond is used to grind non-ferrous materials, because of an adverse reaction between diamond and iron.

- Cemented carbide
- Glass
- Ceramics
- Fiberglass
- Plastics
- Stone
- Abrasives
- Electronic components and materials

#### cBN Grinds:

cBN is used to grind ferrous materials.

- High-speed tool steels
- Die steels
- Hardened carbon steels
- Alloy steels
- Aerospace alloys
- Hardened stainless steel
- Abrasion-resistant ferrous materials



It is the user's responsibility to refer to and comply with ANSI B7.1



These superior, pre-engineered wheels have been specifically developed to meet the demanding needs of precision cutting tool manufactures as well as re-sharpeners. The use of the highest quality diamond and cBN abrasives matched to superior high temperature bond systems, guarantees high performing wheels. These wheels are manufactured under the strictest quality control protocols ensuring the same, consistent, high-performing product. Cutting tool manufactures who use these wheels report much improved dimensional accuracy and superior cutting edges.

This product offering provides wheel sizes for most CNC machines and wheels shapes to produce the required cutting tool geometries. If you do not find a wheel in this offering to suit your specific needs, a custom-made wheel can be provided.

**Applications:** CNC cutting tool manufacturing and resharpening: fluting, end fluting, gashing, and OD relief

## Diamond CNC Wheels

### Best choice for CNC tungsten carbide round tool manufacturing



## PARADIGM DIAMOND WHEELS

- Truable online and offline for maximum productivity
- Wear and load resistance deliver superior grinding performance on tough-to-grind carbides with 6-12% cobalt content
- High grain retention and uniform structure generate high G-ratio; up to 2.5 times longer life and 30% higher MRR than existing superabrasive wheels

### Better choice for CNC tungsten carbide round tool manufacturing



## G-FORCE AND UNIVEL POLYIMIDE DIAMOND WHEELS

- Polyimide bond systems provide superior form-holding and lower-power requirements compared to premium competitive wheels, reducing frequency of dresses, and decreasing chances of burn and heat damage to the part
- Unique bond technology excels on round, carbide and steel tools; excellent depth of cut, traverse rates, and form holding; reduces total grinding costs by 30% or more
- Self-dressing; maintains a consistently sharp grinding edge which allows for lights-out manufacturing

### Good choice for short runs and frequent geometry changes



## DIAMOND CNC WHEELS

- A price competitive alternative to premium wheels; ideal for short-run manufacturing jobs where frequent wheel profile changes are required
- Consistent wheel-to-wheel performance for reduced cycle times, less dressing = longer wheel life
- Ideal for resharpening and short-run manufacturing operations; competitively-priced while providing good performance

Diamond CNC Wheels

TIER: <b>BEST</b>		BETTER				GOOD				
TRADENAME: <b>PARADIGM</b>		<b>G-FORCE/UNIVEL</b>				<b>NORTON WINTER</b>				
SIZE (D x T x H) U, W	ANGLE V	SPECIFICATION	ABR. DEPTH X	PART #	SPECIFICATION	ABR. DEPTH X	PART #	SPECIFICATION	ABR. DEPTH X	PART #
<b>TYPE 1A1 – Diamond Flute</b>										
4 x 1/2 x 1-1/4		SD320-D168-P100C	3/8	079587 <b>83055 NS</b>	AD320-UP061 G-Force	1/4	601576 <b>63909</b>			
5 x 3/8 x 1-1/4		SD320-D168-P100C	1/2	079587 <b>83058 NS</b>	AD320-UP061 G-Force	1/2	601576 <b>68409</b>	A4D220-R115B610	1/2	690141 <b>18255</b>
5 x 1/2 x 1-1/4		SD320-C176-P100C	1/2	079587 <b>83061</b>	AD320-UP061 G-Force	1/2	601576 <b>62240</b>	A4D180-R115B610	1/2	690141 <b>18202</b>
5 x 5/8 x 1-1/4		SD320-C176-P100C	1/2	079587 <b>83063 NS</b>	AD320-UP061 G-Force	1/2	601576 <b>63486 NS</b>	A4D180-R115B610	1/2	690141 <b>18203 NS</b>
6 x 1/2 x 1-1/4		SD320-C176-P100C	1/2	079587 <b>83064</b>	AD320-UP061 G-Force	1/4	601576 <b>82133 NS</b>	A4D180-R115B610	1/4	690141 <b>18216 NS</b>
<b>TYPE 1A1 – Diamond Polish</b>										
5 x 1/2 x 1-1/4					80D1000-100UP731 Univel	1/2	079587 <b>84316 NS</b>			
<b>TYPE 1A1 – Diamond Relief</b>										
6 x 1/2 x 1-1/4		SD320-E168-P100C	1/2	079587 <b>83073 NS</b>	AD320-UP892 G-Force	1/2	690141 <b>17684 NS</b>	A4D180-R115B610	1/2	690141 <b>18217 NS</b>
<b>TYPE 1A1RN – Diamond Flute</b>										
5 x 3/8 x 1-1/4		SD320-D168-P100C	1/2	079587 <b>83067 NS</b>	AD320-UP061 G-Force	1/2	601576 <b>63501</b>	A4D180-R115B610	1/2	690141 <b>18201</b>
5 x 1/2 x 1-1/4					AD220-UP061 G-Force	1/2	662603 <b>22280</b>			
5 x 5/8 x 1-1/4					AD220-UP061 G-Force	1/2	601576 <b>64141</b>			
<b>TYPE 1B1 – Diamond Flute</b>										
4 x 3/8 x 1-1/4	V=20°	SD320-D168-P100C	3/8	079587 <b>83054</b>						
<b>TYPE 1B1 – Diamond Flute/Gash</b>										
5 x 3/8 x 1-1/4	V=45°	SD320-E168-P100C	1/2	079587 <b>83065</b>						
<b>TYPE 1B1 – Diamond Gash</b>										
5 x 1/2 x 1-1/4	V=45°	SD320-E168-P100C	1/4	079587 <b>83062 NS</b>						
5 x 1/2 x 1-1/4	V=60°	SD320-E168-P100C	1/4	079587 <b>83060 NS</b>						
5 x 1/2 x 1-1/4	V=30°	SD320-E168-P100C	3/4	079587 <b>83070 NS</b>				A4D320-R115B610	3/4	690141 <b>18207</b>
								D220-C100-K+925	6mm	601576 <b>13112</b>
5 x 1/2 x 1-1/4	V=45°	SD320-E168-P100C	3/4	079587 <b>83068 NS</b>	AD320-UP531 G-Force	3/4	662603 <b>29603</b>	A4D320-R115B610	3/4	690141 <b>18208</b>
								D220-C100-K+925	6mm	601576 <b>23673</b>
<b>TYPE 1V1 – Diamond Flute</b>										
4 x 3/8 x 1-1/4	V=20°				AD320-UP061 G-Force	1/4	662603 <b>16591</b>	A4D180-R115B610	1/4	690141 <b>18263</b>
5 x 1/2 x 1-1/4	V=10°	SD320-C176-P100C	1/2	079587 <b>83071 NS</b>	AD320-UP061 G-Force	1/2	662601 <b>16723</b>	A4D180-R115B610	1/2	690141 <b>18204</b>
5 x 1/2 x 1-1/4	V=20°	SD320-C176-P100C	1/2	079587 <b>83074</b>	AD320-UP061 G-Force	1/2	601576 <b>93843</b>	A4D180-R115B610	1/2	690141 <b>18205</b>
								D220-C100-K+925	6mm	601576 <b>23953</b>
5 x 1/2 x 1-1/4	V=30°	SD320-C176-P100C	1/2	079587 <b>83085 NS</b>	AD320-UP671 G-Force	1/2	601576 <b>93841</b>	A4D180-R115B610	1/2	690141 <b>18206</b>
<b>TYPE 1V1 – Diamond Flute/Gash</b>										
5 x 3/8 x 1-1/4	V=45°				AD320-UP531 G-Force	1/2	601576 <b>96562</b>	A4D320-R115B610	1/2	690141 <b>18257</b>
<b>TYPE 1V1 – Diamond Gash</b>										
5 x 1/2 x 1-1/4	V=45°				AD320-UP531 G-Force	1/4	662603 <b>29604</b>	A4D320-R115B610	1/4	690141 <b>18209</b>
5 x 1/2 x 1-1/4	V=60°				AD320-UR331 Univel	1/4	662603 <b>29469</b>			

NS Non-stock, contact your Norton representative for current lead-times.  
All holes (bores) are machined to (H7) class fit.

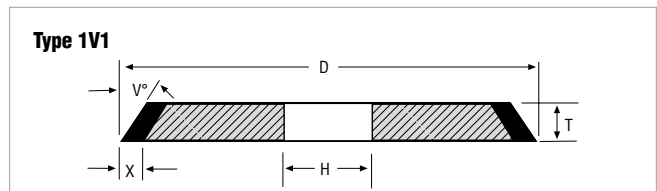
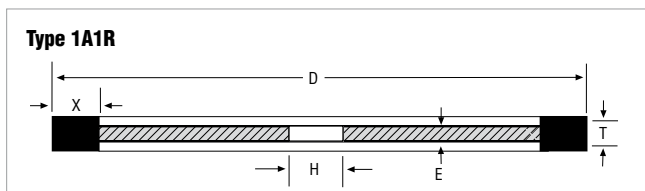
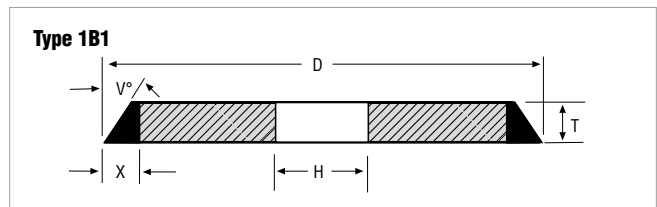
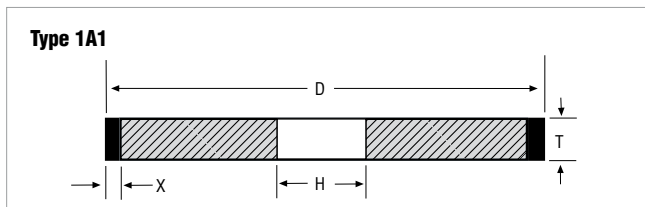

Diamond CNC Wheels

TIER: <b>BEST</b>		BETTER				GOOD				
TRADENAME: <b>PARADIGM</b>		<b>G-FORCE/UNIVEL</b>				<b>NORTON WINTER</b>				
SIZE (D x T x H) U, W	ANGLE V	SPECIFICATION	ABR. DEPTH X	PART #	SPECIFICATION	ABR. DEPTH X	PART #	SPECIFICATION	ABR. DEPTH X	PART #
<b>TYPE 6A2 – Diamond Point</b>										
4 x 1-1/4 x 1-1/4 W=1/4		SD320-E168-P100C	1/4	079587 <b>83057NS</b>	AD320-UP251 G-Force	1/4	690141 <b>18644NS</b>	ASD320C-R100B56	1/4	690141 <b>18219NS</b>
<b>TYPE 11A2 – Diamond Relief</b>										
3 x 1-1/4 x 1-1/4 W=1/4					10D320-NB100U Univel	1/4	601576 <b>92199</b>			
4 x 1-1/4 x 1-1/4 W=1/4		SD320-E168-P100C	1/4	079587 <b>83059NS</b>	AD320-UP701 G-Force	1/4	601576 <b>96315</b>	ASDC320-R100B80	1/4	690141 <b>18213</b>
4 x 1-1/4 x 1-1/4 W=1/4					AD320-UP561 G-Force	1/4	690141 <b>18479NS</b>	ASDC320-R100B80	1/4	690141 <b>18265NS</b>
<b>TYPE 11V5 – Diamond Relief</b>										
4 x 1-1/4 x 1-1/4 V=30° W=1/4					AD320-UP561 G-Force	1/4	690141 <b>17838</b>	ASDC320-R100B80	1/4	690141 <b>18211</b>
4 x 1-1/4 x 1-1/4 V=10° W=3/8					AD320-UP561 G-Force	1/4	690141 <b>17812</b>	ASDC320-R100B80	1/4	690141 <b>18212</b>
<b>TYPE 11V9 – Diamond Relief</b>										
3-3/4 x 1-1/2 x 1-1/4 U=3/8					10D240-PB125-U Univel	1/8	662603 <b>22134</b>	ASDC320-R100B80	1/8	690141 <b>18259</b>
5 x 1-3/4 x 1-1/4 U=5/8					10D240-PB125-U Univel	1/8	662601 <b>18300</b>	ASDC320-R100B80	1/8	690141 <b>18215</b>
<b>TYPE 12V9 – Diamond Relief</b>										
4 x 3/4 x 1-1/4 U=3/8					AD320-UP531 G-Force	1/8	662601 <b>27950NS</b>	ASDC320-R100B80	1/8	690141 <b>18221NS</b>
5 x 3/4 x 1-1/4 U=1/2					AD320-UP531 G-Force	1/8	662601 <b>27911NS</b>	ASDC320-R100B80	1/8	690141 <b>18222NS</b>

NS Non-stock, contact your Norton representative for current lead-times.  
All holes (bores) are machined to (H7) class fit.

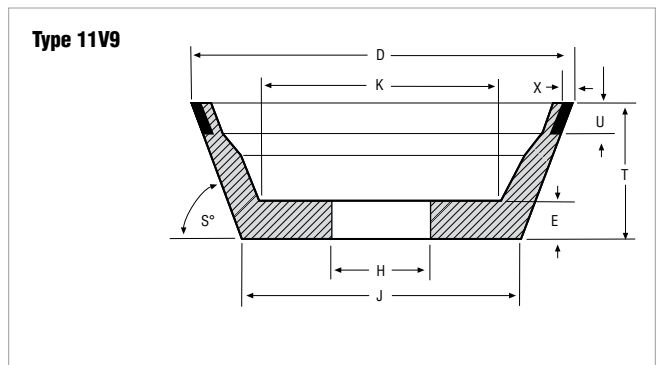
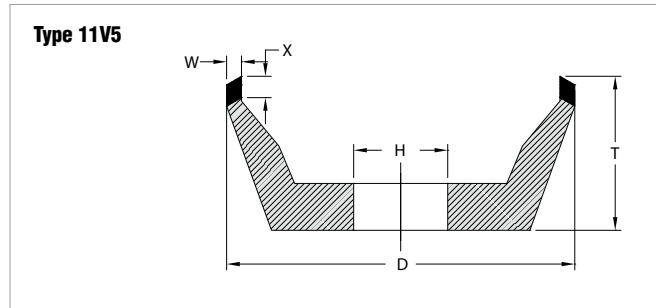
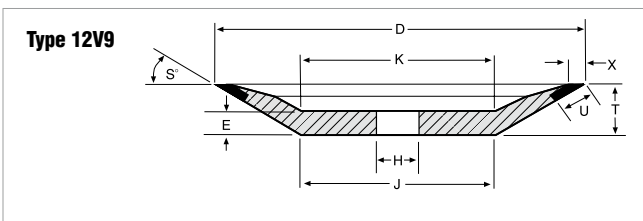
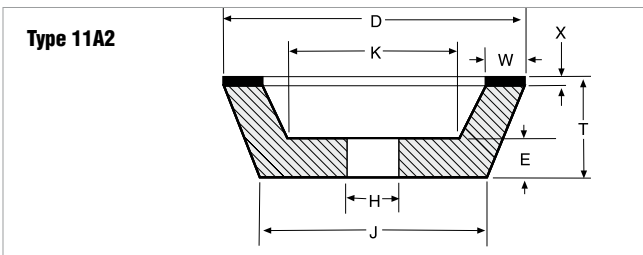
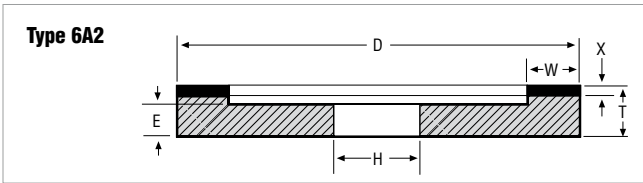

**TECH TIP**

**Diamond Grinds:**

In general, diamond is used to grind non-ferrous materials, because it reacts with iron.

- Cemented carbide
- Glass
- Ceramics
- Fiberglass
- Plastics
- Stone
- Abrasives
- Electronic components and materials



It is the user's responsibility to refer to and comply with ANSI B7.1

cBN CNC Wheels



Best choice for CNC HSS round tool manufacturing

**G-FORCE / UNIVEL cBN WHEELS**

- Truable online and offline for lights-out manufacturing and maximum productivity
- Wear and load resistance deliver superior grinding performance on tough-to-grind carbides with 6-12% cobalt content
- Low specific cutting energy for faster grinding with lower power draw and less burn



Good choice for short runs and frequent geometry changes

**cBN CNC WHEELS**

- A price competitive alternative to premium wheels; ideal for short-run manufacturing jobs where frequent wheel profile changes are required
- Consistent wheel-to-wheel performance for reduced cycle times, less dressing = longer wheel life
- Ideal for resharpening and short-run manufacturing operations; competitively-priced while providing good performance

TIER: **BEST**  
TRADENAME: **G-FORCE/UNIVEL**

**GOOD**  
**NORTON WINTER**

SIZE (D x T x H) U, W	ANGLE V	SPECIFICATION	ABR. DEPTH X	PART #	SPECIFICATION	ABR. DEPTH X	PART #
<b>TYPE 1A1 – cBN Flute</b>							
4 x 1/2 x 1-1/4		BX220-UP241 G-Force	1/4	601576 <b>69935 NS</b>	BAM180-WBXD3037	1/4	690141 <b>18223 NS</b>
					B220-V240-KSS920	6mm	601576 <b>23498</b>
5 x 3/8 x 1-1/4		BX220-UP241 G-Force	1/2	690141 <b>18436 NS</b>	BAM320C-WBXD3037	1/2	690141 <b>18256 NS</b>
5 x 1/2 x 1-1/4		BX220-UP241 G-Force	1/2	601576 <b>70869 NS</b>	BAM180-WBXD3037	1/2	690141 <b>18224 NS</b>
					B220-V240-KSS920	6mm	601576 <b>02944</b>
5 x 5/8 x 1-1/4		BX220-UP241 G-Force	1/2	662603 <b>29385 NS</b>	BAM180-WBXD3037	1/2	690141 <b>18225 NS</b>
6 x 1/4 x 1-1/4		BX240-UP241 G-Force	1/4	690141 <b>18435 NS</b>	BAM180-WBXD3037	1/4	690141 <b>18240 NS</b>
<b>TYPE 1A1 – cBN Relief</b>							
6 x 1/2 x 1-1/4		BX320-UP892 G-Force	1/2	690141 <b>17679 NS</b>	BAM180-WBXD3037	1/2	690141 <b>18237 NS</b>
<b>TYPE 1A1RN – cBN Flute</b>							
5 x 1/4 x 1-1/4		BX150-UP241 G-Force	1/2	079587 <b>73216 NS</b>			
5 x 3/8 x 1-1/4		BX150-UP241 G-Force	1/2	079587 <b>73217 NS</b>			
5 x 1/2 x 1-1/4		BX150-UP241 G-Force	1/2	690141 <b>41373 NS</b>			
<b>TYPE 1B1 – cBN Gash</b>							
5 x 1/2 x 1-1/4	V=30°	BX320-UP701 G-Force	3/4	662603 <b>29388 NS</b>	BAM320C-WBXD3037	3/4	690141 <b>18229 NS</b>
5 x 1/2 x 1-1/4	V=45°	BX320-UP531 G-Force	3/4	662603 <b>29391 NS</b>	BAM320C-WBXD3037	3/4	690141 <b>18230 NS</b>
					B220-V240-KSS920	6mm	601576 <b>23542</b>
<b>TYPE 1V1 – cBN Flute</b>							
4 x 3/8 x 1-1/4	V=20°	BX220-UP241 G-Force	1/4	690141 <b>18342 NS</b>	BAM180C-WBXD3037	1/4	690141 <b>18264 NS</b>
5 x 1/2 x 1-1/4	V=20°	BX220-UP241 G-Force	1/2	601576 <b>80042 NS</b>	BAM180-WBXD3037	1/2	690141 <b>18227 NS</b>
					B220-V240-KSS920	6mm	601576 <b>23944 NS</b>
5 x 1/2 x 1-1/4	V=30°	BX220-UP241 G-Force	1/2	601576 <b>91380 NS</b>	BAM180-WBXD3037	1/2	690141 <b>18228 NS</b>
5 x 1/2 x 1-1/4	V=10°	BX220-UP241 G-Force	1/2	662601 <b>19876 NS</b>	BAM180-WBXD3037	1/2	690141 <b>18226 NS</b>
<b>TYPE 1V1 – cBN Flute/Gash</b>							
5 x 3/8 x 1-1/4	V=45°	BX220-UP531 G-Force	1/2	601576 <b>97699 NS</b>	BAM320C-WBXD3037	1/4	690141 <b>18262 NS</b>
					B220-V240-KSS920	6mm	601576 <b>23524</b>
<b>TYPE 1V1 – cBN Gash</b>							
5 x 1/2 x 1-1/4	V=60°	BX320-UR331 Univel	1/4	662603 <b>29461 NS</b>	BAM320C-WBXD3037	1/4	690141 <b>18232 NS</b>
5 x 1/2 x 1-1/4	V=45°	BX320-UP531 G-Force	1/4	662603 <b>29275 NS</b>	BAM320C-WBXD3037	1/4	690141 <b>18231 NS</b>
					B220-V240-KSS920	6mm	601576 <b>23776</b>

**TECH TIP**

**cBN Grinds:**

cBN is used to grind ferrous materials.

- High-speed tool steels
- Die steels
- Hardened carbon steels
- Alloy steels
- Aerospace alloys
- Hardened stainless steel
- Abrasion-resistant ferrous materials



It is the user's responsibility to refer to and comply with ANSI B7.1

NS Non-stock, contact your Norton representative for current lead-times.  
All holes (bores) are machined to (H7) class fit.

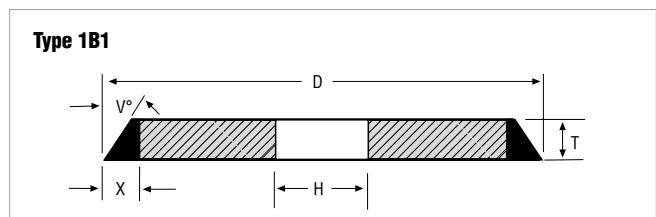
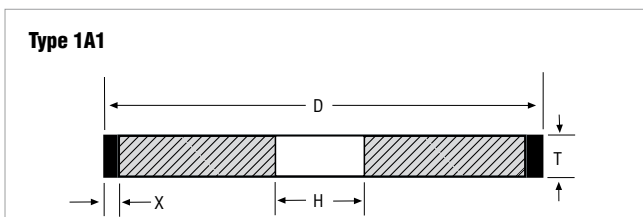

cBN CNC Wheels

TIER: **BEST** **GOOD**  
TRADENAME: **G-FORCE/UNIVEL** **NORTON WINTER**

SIZE (D x T x H) U, W	ANGLE V	SPECIFICATION	ABR. DEPTH X	PART #	SPECIFICATION	ABR. DEPTH X	PART #
<b>TYPE 6A2 – cBN Point</b>							
4 x 1-1/4 x 1-1/4 W=1/4		BX320-UP241 G-Force	1/4	690141 <b>18543</b> NS	CB320C-WBB	1/4	690141 <b>18239</b> NS
5 x 1-1/4 x 1-1/4 W=1/2		BX320-UP241 G-Force	1/4	690141 <b>18447</b> NS	CB320C-WBB	1/4	690141 <b>18238</b> NS
<b>TYPE 11A2 – cBN Relief</b>							
5 x 1-1/2 x 2 W=1/4		BX320-UP531 G-Force	1/4	690141 <b>18406</b> NS	BAM220-WBE	1/4	690141 <b>18254</b> NS
<b>TYPE 11A2 – cBN Relief</b>							
4 x 1-1/4 x 1-1/4 W=1/4		BX320-UP531 G-Force	1/4	690141 <b>18445</b> NS	BAM220-WBE	1/4	690141 <b>18266</b> NS
<b>TYPE 11V5 – cBN Relief</b>							
4 x 1-1/4 x 1-1/4 W=1/4	V=30°	BX320-UP701 G-Force	1/4	690141 <b>17833</b> NS	BAM220-WBE	1/4	690141 <b>18233</b> NS
					B220-J240-KSS63Y	6mm	601576 <b>23563</b>
4 x 1-1/4 x 1-1/4 W=3/8	V=10°	BX320-UP701 G-Force	1/4	690141 <b>17820</b> NS	BAM220-WBE	1/4	690141 <b>18234</b> NS
<b>TYPE 11V9 – cBN Relief</b>							
3-3/4 x 1-1/2 x 1-1/4 U=3/8		90B240-PB125-U Univel	1/8	690141 <b>18345</b> NS	BAM220-WBE	1/8	690141 <b>18260</b> NS
<b>TYPE 11V9 – cBN Relief</b>							
3-3/4 x 1-1/2 x 1-1/4 U=3/8		90B240-PB125-U Univel	1/8	690141 <b>18029</b> NS	BAM220-WBE	1/8	690141 <b>18235</b> NS
5 x 1-3/4 x 2 U=3/8		90B240-PB125-U Univel	1/8	690141 <b>18043</b> NS	BAM220-WBE	1/8	690141 <b>18248</b> NS
<b>TYPE 12V9 – cBN Relief</b>							
4 x 3/4 x 1-1/4 U=3/8		BX320-UP531 G-Force	1/8	690141 <b>18470</b> NS	BAM220-WBE	1/8	690141 <b>18241</b> NS
5 x 3/4 x 1-1/4 U=1/2		BX320-UP531 G-Force	1/8	690141 <b>18441</b> NS	BAM220-WBE	1/8	690141 <b>18242</b> NS

NS Non-stock, contact your Norton representative for current lead-times.  
All holes (bores) are machined to (H7) class fit.

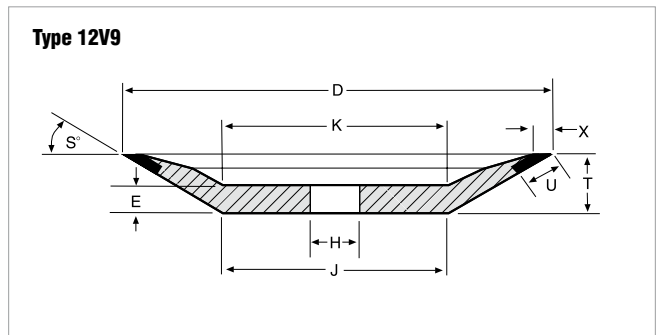
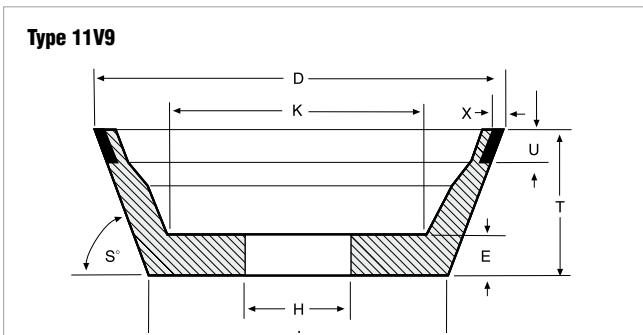
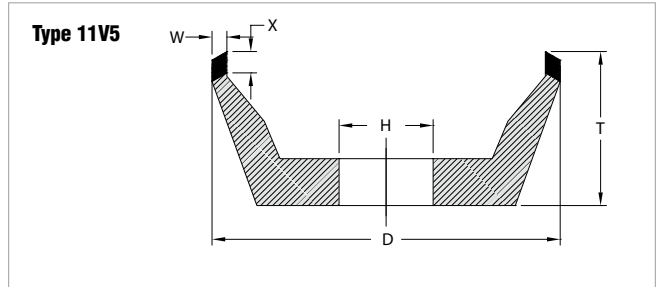
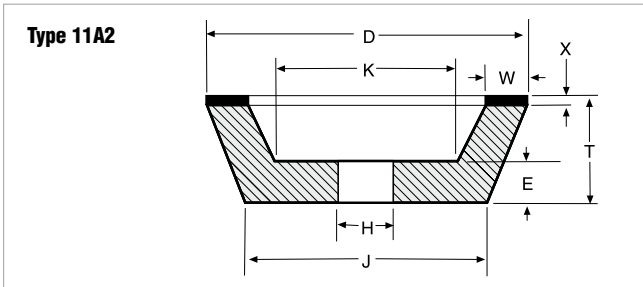
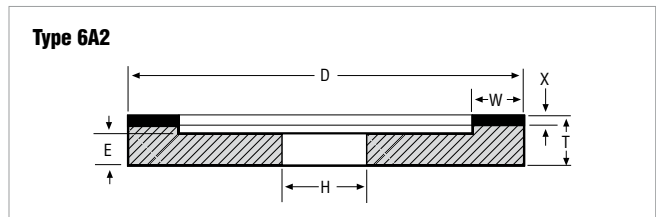
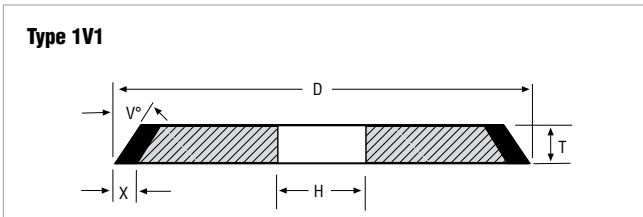

### CNC Express Wheel Service for WC and HSS Tools

- G-Force Diamond and cBN wheels altered from blank stock
- Available for a large range of special geometries
- 2-week standard lead time for first-time orders (new part numbers)
- 1-week lead-time for repeat orders (existing part numbers)

#### How To Request An Express Wheel Quote And Order

Refer to this chart and choose:

- Wheel shape by application
- Diameter "D"
- Thickness "T" from the range of 7/16" to 1/2"
- Hole "H" from the range of 1/2" to 2"
- Angle ("V"), Radius ("R") dimensions from the range provided
- Abrasive depth "X" will always be 1/2" for these CNC wheels
- Specifications required for material and application
- NOTE: Please remember to include the "E" at the end of the specification to indicate Express lead-time is required

### CNC Express Blank Stock for Made-To-Order Wheels

Blank Stock Inventory to be altered to your specifications within 5-10 days

Wheel Shape	Tool Material	Application	G-Force Specification AD = Diamond BX = cBN	Diameter D	THK. T	Hole H	Abr. Depth X	Angle (V) or Radius (R)
	WC	Fluting	AD320-UP061E	5	7/16" min. to 1/2" max.	1/2" min. to 2" max.	1/2"	-
	HSS	Fluting	BX320-UP241E	5				
	WC	Fluting	AD320-UP061E	6				
	WC	Fluting	AD320-UP061E	5				
	WC	Fluting	AD320-UP061E	6				
	HSS	Fluting	BX320-UP241E	5				
	WC	Gashing	AD320-UP531E	5				
	HSS	Gashing	BX320-UP531E	5				
	WC	Fluting	AD320-UP061E	5				
	HSS	Fluting	BX320-UP241E	5				
	WC	Fluting	AD320-UP061E	6				
	WC	Fluting	AD320-UP061E	5				
	HSS	Fluting	BX320-UP241E	5				
	WC	Fluting	AD320-UP061E	6				
	WC	Fluting	AD320-UP061E	5				
	HSS	Fluting	BX320-UP241E	5				
	WC	Fluting	AD320-UP061E	6				
	WC	Fluting	AD320-UP061E	5				
	HSS	Fluting	BX320-UP241E	5				
	WC	Fluting	AD320-UP061E	6				

Note: all of the wheel shapes listed can also be designated to have .010 relief(s) 1 side, or 2 sides on 1A1P and 1A1RN wheels.





Our extensive offering of stock diamond and cBN electroplated products has been engineered to meet the diverse demands of traditional and emerging tool and die, ceramic, and composite applications.

- Applications:** Small hole/ID grinding, deburring, cleaning, honing, precision drilling, forming dies and molds, routing, reaming, blending radii, notching and cutting-off with saw blades in ceramic, tool and die, and composite applications
- Product Types:**
- Mounted points
  - Mandrels
  - Drills
  - Routers
  - Contour tools
  - Wheels
  - Files
  - Saw blades
- Abrasive Grain:** Diamond or cBN (cubic Boron Nitride)

Maintain tight tolerances and provide superior form holding; can be used wet or dry



## ELECTROPLATED PRODUCTS

- Nickel alloy matrix creates a tough, durable bond
- Single layer of abrasive offers an economical choice
- Exposed particles for aggressive cutting action

### Identifying Target Markets

An industry is provided beside each product. This key identifies markets that typically use the product.

#### TARGET MARKET SYMBOLS

- = Ceramics      ▲ = Tool & Die      ■ = Composites

## TECH TIP

### Abrasive Applications

Although diamond and cBN (cubic Boron Nitride) are both superabrasives, the use of diamond and cBN varies, depending upon the materials to be ground.

**Diamond Grinds:**

- Cemented carbide
- Glass
- Ceramics
- Fiberglass
- Plastics
- Composites
- Abrasives
- Stone
- Electronic components and materials

**cBN Grinds:**

- High-speed tool steels
- Die steel
- Hardened carbon steels
- Hardened stainless steels
- Alloy steels
- Aerospace alloys
- Abrasion-resistant ferrous materials

In general, cBN is used to grind ferrous materials. Diamond is used to grind non-ferrous materials, because of an adverse reaction between diamond and iron.

## Made-to-Order Electroplated Product Guide

The stock electroplated products offered on the following pages have been engineered to meet the diversity of demands typical in today's manufacturing environment. When special forms, shapes, and configurations are required, Norton Winter electroplated diamond and cBN products can be fabricated in almost any geometry.

## Customer-Supplied Preforms and Blanks

Customers may prefer to manufacture their own preforms/blanks for custom products and in many cases this can reduce cost and lead-times. The instructions below detail the necessary allowances for each grit size. Please refer to these whenever manufacturing blanks.

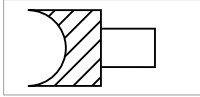

### Area to be plated (female radius)

Female radius must be larger than the finished size required.  
Example – If a .500 female radius is required with 60/80 grit, then the blank should be manufactured .011 larger = .511

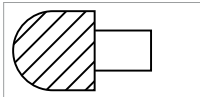

### Area to be plated (male radius)

A male radius must be smaller than the finished size required.  
Example – If a .500 male radius is required with 60/80 grit, then the blank should be manufactured .011 smaller = .489

## Grit Size Allowance for Plated Products

ALLOWANCE/GRIT SIZE	PARTICLE SIZE
20/30	.035
30/40	.025
40/50	.018
60/80	.011
80/100	.008
100/120	.007
120/140	.006
140/170	.005
170/200	.004
200/230	.0035
270/325	.003
4.5 Micron – 400	.0025
30 Micron – 600	.0016
15 Micron – 1200	.001

*This should be used as a guide when manufacturing blanks to be plated with diamond or cBN.*

## Surface Finish

Use this chart only as a guide. Surface finish is affected by a number of variables: machine type and condition, type of material, coolant, wheel speed, bond system, etc.

### Expected RMS Finish

GRIT SIZE	ELECTROPLATED
80	90-125
100	64-90
120	48-64
150	32-48
180	24-32
220	20-24
240	16-20
320	16-20
400	14-20
500	12-13
600	12

## Strip and Replate Services

Ask Customer Service for information and quotations on our complete strip and replat services on many electroplated products.

## TECH TIP

### Coolants

Although coolants may not be necessary, using a coolant produces superior surface finishes, a longer tool life, higher performance, and reduces tool loading.

### Feeds

Suggested feeds for jig or internal grinding are from .0002" – .0004" per pass.

### Speeds

#### Maximum Operating Speeds (MOS)

Never exceed the maximum operating speed marked on the superabrasive product being used.

- Electroplated Products: 25,000 SFPMO SFPM

Maximum speeds of mounted points are a function of the length of overhang and size of the product. Refer to "Safe Operating Speeds" in form #2872, provided with your product.

#### Recommended Operating Speeds

The preceding speed is the maximum safe speed and not necessarily the most efficient. Superabrasive products operate most effectively at speeds lower than the maximum. The following are general recommendations. cBN products, in many cases, are used effectively at higher speeds.

- Electroplated Diamond Products: 5,000 to 10,000 SFPM
- Electroplated cBN Products: 8,000 to 10,000 SFPM

#### Calculating Operating Speed

The following formula may be used to quickly calculate wheel speed:

- RPM = Revolutions Per Minute
- SFPM = Surface Feet Per Minute

To convert SFPM to RPM: (Multiply SFPM x 3.82) divided by wheel diameter in inches

## Electroplated Mounted Points

Diamond and cBN Mounted Points ● ▲

- Use diamond mounted points for precise, small hole, jig and internal grinding of carbide, ceramics, sapphire, glass, and a variety of tough, super alloys
- For grinding tough, high carbon, high chrome steel, use cBN mounted points
- Mandrels are made of high-speed tool steel to withstand operating pressure

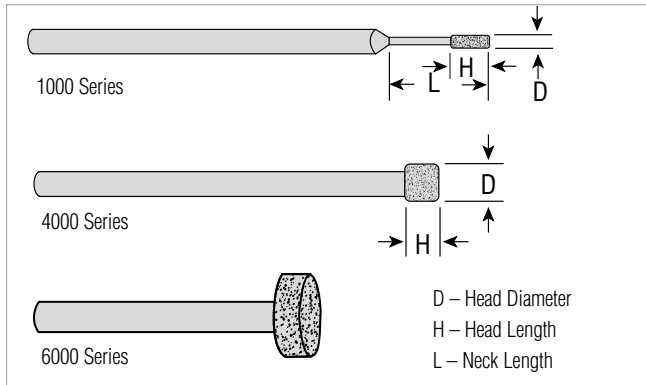

PART #	PRODUCT #	HEAD DIAMETER INCHES	HEAD LENGTH	NECK LENGTH	GRIT SIZE
<b>1000 Series – Diamond</b>					
<b>1/8" Shank x 2-1/4" Overall Length</b>					
66260392429	1016FD	.016	.079	1/8	200
66260392432	1020MD	.020	.079	1/8	150
66260392431	1020FD	.020	.079	1/8	200
66260392436	1025MD	.025	.079	1/8	150
66260392435	1025FD	.025	.079	1/8	200
66260392440	1030MD	.030	.079	1/4	150
66260392439	1030FD	.030	.079	1/4	200
66260392445	1035CD	.035	.118	1/4	100
66260392444	1035MD	.035	.118	1/4	150
66260392443	1035FD	.035	.118	1/4	200
66260392451	1040CD	.040	.118	1/4	100
66260392450	1040MD	.040	.118	1/4	150
66260392449	1040FD	.040	.118	1/4	200
66260392457	1045CD	.045	.118	1/4	100
66260392456	1045MD	.045	.118	1/4	150
66260392455	1045FD	.045	.118	1/4	200
66260392463	1050CD	.050	.118	1/2	100
66260392462	1050MD	.050	.118	1/2	150
66260392461	1050FD	.050	.118	1/2	200
66260392469	1050LCD	.050	.118	1	100
66260392468	1050LMD	.050	.118	1	150
66260392467	1050LFD	.050	.118	1	200
66260392475	1055CD	.055	.118	1/2	100
66260392474	1055MD	.055	.118	1/2	150
66260392473	1055FD	.055	.118	1/2	200
66260392481	1060CD	.060	.157	1/2	100
66260392480	1060MD	.060	.157	1/2	150
66260392479	1060FD	.060	.157	1/2	200
66260392487	1060LCD	.060	.157	1	100
66260392492	1065MD	.065	.157	1/2	150
66260392491	1065FD	.065	.157	1/2	200
66260392499	1070CD	.070	.157	1/2	100
66260392498	1070MD	.070	.157	1/2	150
66260392497	1070FD	.070	.157	1/2	200
66260392505	1070LCD	.070	.157	1	100
66260392511	1075CD	.075	.157	1/2	100
66260392510	1075MD	.075	.157	1/2	150
66260392509	1075FD	.075	.157	1/2	200

Continued

PART #	PRODUCT #	HEAD DIAMETER INCHES	HEAD LENGTH	NECK LENGTH	GRIT SIZE
<b>1000 Series – Diamond (continued)</b>					
<b>1/8" Shank x 2-1/4" Overall Length</b>					
66260392517	1080CD	.080	.157	1/2	100
66260392516	1080MD	.080	.157	1/2	150
66260392515	1080FD	.080	.157	1/2	200
66260392523	1080LCD	.080	.157	1	100
66260392521	1080LFD	.080	.157	1	200
66260392529	1085CD	.085	.157	1/2	100
66260392528	1085MD	.085	.157	1/2	150
66260392535	1090CD	.090	.157	1/2	100
66260392534	1090MD	.090	.157	1/2	150
66260392533	1090FD	.090	.157	1/2	200
66260392541	1090LCD	.090	.157	1	100
66260392540	1090LMD	.090	.157	1	150
66260392547	1095CD	.095	.157	1/2	100
66260392546	1095MD	.095	.157	1/2	150
66260392553	1100CD	.100	.157	1/2	100
66260392552	1100MD	.100	.157	1/2	150
66260392551	1100FD	.100	.157	1/2	200
66260392565	1105CD	.105	.157	1/2	100
66260392563	1105FD	.105	.157	1/2	200
66260392577	1110CD	.110	.157	1/2	100
66260392576	1110MD	.110	.157	1/2	150
66260392583	1110LCD	.110	.157	1	100
66260392589	1115CD	.115	.157	1/2	100
66260392588	1115MD	.115	.157	1/2	150
66260392595	1120CD	.120	.157	1/2	100
66260392594	1120MD	.120	.157	1/2	150
66260392593	1120FD	.120	.157	1/2	200
66260392601	1125CD	.125	.157	1/2	100
66260392600	1125MD	.125	.157	1/2	150
66260392599	1125FD	.125	.157	1/2	200
66260392607	1130CD	.130	.197	1	100
66260392606	1130MD	.130	.197	1	150
66260392613	1135CD	.135	.236	N/A	100
66260392612	1135MD	.135	.236	N/A	150
66260392611	1135FD	.135	.236	N/A	200
66260392619	1140CD	.140	.236	N/A	100
66260392625	1156CD	.156	.236	N/A	100
66260392624	1156MD	.156	.236	N/A	150
66260392623	1156FD	.156	.236	N/A	200
66260392730	1171MD	.171	.236	N/A	150
66260392730	1171MD	.171	.236	N/A	150
66260392737	1187CD	.187	.312	N/A	100
66260392735	1187FD	.187	.312	N/A	200
66260392742	1203MD	.203	.312	N/A	150
66260392741	1203FD	.203	.312	N/A	200
66260392748	1218MD	.218	.312	N/A	150
66260392747	1218FD	.218	.312	N/A	200
66260392755	1250CD	.250	.312	N/A	100
66260392754	1250MD	.250	.312	N/A	150
66260392753	1250FD	.250	.312	N/A	200
66260363450	1750MD	.750	.035	N/A	150

**TARGET MARKET SYMBOLS**

- = Ceramics
- ▲ = Tool & Die
- = Composites

Electroplated Mounted Points

Diamond and cBN Mounted Points ● ▲

PART #	PRODUCT #	HEAD DIAMETER INCHES	HEAD LENGTH	NECK LENGTH	GRIT SIZE
<b>1000 Series – cBN</b>					
<b>1/8" Shank x 2-1/4" Overall Length</b>					
66260392434	1020MC	.020	.079	1/8	150
66260392442	1030MC	.030	.079	1/4	150
66260392453	1040MC	.040	.118	1/4	150
66260392460	1045CC	.045	.118	1/4	100
66260392466	1050CC	.050	.118	1/2	100
66260392465	1050MC	.050	.118	1/2	150
66260392464	1050FC	.050	.118	1/2	200
66260392484	1060CC	.060	.157	1/2	100
66260392483	1060MC	.060	.157	1/2	150
66260392482	1060FC	.060	.157	1/2	200
66260392496	1065CC	.065	.157	1/2	100
66260392502	1070CC	.070	.157	1/2	100
66260392501	1070MC	.070	.157	1/2	150
66260392500	1070FC	.070	.157	1/2	200
66260392514	1075CC	.075	.157	1/2	100
66260392520	1080CC	.080	.157	1/2	100
66260392532	1085CC	.085	.157	1/2	100
66260392538	1090CC	.090	.157	1/2	100
66260392537	1090MC	.090	.157	1/2	150
66260392536	1090FC	.090	.157	1/2	200
66260392543	1090LMC	.090	.157	1	150
66260392556	1100CC	.100	.157	1/2	100
66260392554	1100FC	.100	.157	1/2	200
66260392561	1100LMC	.100	.157	1	150
66260392568	1105CC	.105	.157	1/2	100
66260392567	1105MC	.105	.157	1/2	150
66260392580	1110CC	.110	.157	1/2	100
66260392578	1110FC	.110	.157	1/2	200
66260392598	1120CC	.120	.157	1/2	100
66260392604	1125CC	.125	.157	1/2	100
66260392603	1125MC	.125	.157	1/2	150
66260392602	1125FC	.125	.157	1/2	200
66260392610	1130CC	.130	.197	1	100
66260392608	1130FC	.130	.197	1	200
66260392616	1135CC	.135	.236	N/A	100
66260392615	1135MC	.135	.236	N/A	150
66260392622	1140CC	.140	.236	N/A	100
66260392628	1156CC	.156	.236	N/A	100
66260392627	1156MC	.156	.236	N/A	150
66260392626	1156FC	.156	.236	N/A	200
66260392734	1171CC	.171	.236	N/A	100
66260392733	1171MC	.171	.236	N/A	150
66260392740	1187CC	.187	.312	N/A	100
66260392739	1187MC	.187	.312	N/A	150
66260392738	1187FC	.187	.312	N/A	200
66260392745	1203MC	.203	.312	N/A	150
66260392751	1218MC	.218	.312	N/A	150
66260392758	1250CC	.250	.312	N/A	100
66260392757	1250MC	.250	.312	N/A	150

PART #	PRODUCT #	HEAD DIAMETER INCHES	HEAD LENGTH	NECK LENGTH	GRIT SIZE
<b>4000 Series – Diamond</b>					
<b>1/4" Shank x 3" Overall Length</b>					
66260392630	4156CD	.156	.250	1	100
66260392629	4156FD	.156	.250	1	200
66260392634	4187CD	.187	.250	1	100
66260392633	4187FD	.187	.250	1	200
66260392638	4203CD	.203	.250	1	100
66260392642	4218CD	.218	.250	1	100
66260392641	4218FD	.218	.250	1	200
66260392646	4236CD	.236	.250	1	100
66260392645	4236FD	.236	.250	1	200
66260392650	4250CD	.250	.250	1	100
66260392649	4250FD	.250	.250	1	200
66260392654	4282CD	.282	.250	N/A	100
66260392653	4282FD	.282	.250	N/A	200
66260392658	4312CD	.312	.375	N/A	100
66260392657	4312FD	.312	.375	N/A	200
66260392662	4375CD	.375	.375	N/A	100
66260392661	4375FD	.375	.375	N/A	200
66260392666	4390CD	.390	.375	N/A	100
66260392670	4406CD	.406	.375	N/A	100
66260392674	4437CD	.437	.375	N/A	100
66260392678	4500CD	.500	.375	N/A	100
66260392677	4500FD	.500	.375	N/A	200
66260392682	4730CD	.730	.375	N/A	100
66260392690	41000CD	1.000	.375	N/A	100
66260392689	41000FD	1.000	.375	N/A	200
<b>4000 Series – cBN</b>					
<b>1/4" Shank x 3" Overall Length</b>					
66260392632	4156CC	.156	.250	1	100
66260392631	4156FC	.156	.250	1	200
66260392636	4187CC	.187	.250	1	100
66260392635	4187FC	.187	.250	1	200
66260392640	4203CC	.203	.250	1	100
66260392639	4203FC	.203	.250	1	200
66260392644	4218CC	.218	.250	1	100
66260392643	4218FC	.218	.250	1	200
66260392648	4236CC	.236	.250	1	100
66260392647	4236FC	.236	.250	1	200
66260392652	4250CC	.250	.250	1	100
66260392651	4250FC	.250	.250	1	200
66260392656	4282CC	.282	.250	N/A	100
66260392655	4282FC	.282	.250	N/A	200
66260392660	4312CC	.312	.375	N/A	100
66260392659	4312FC	.312	.375	N/A	200
66260392664	4375CC	.375	.375	N/A	100
66260392663	4375FC	.375	.375	N/A	200
66260392668	4390CC	.390	.375	N/A	100
66260392672	4406CC	.406	.375	N/A	100
66260392676	4437CC	.437	.375	N/A	100
66260392675	4437FC	.437	.375	N/A	200
66260392680	4500CC	.500	.375	N/A	100
66260392679	4500FC	.500	.375	N/A	200
66260392684	4730CC	.730	.375	N/A	100
66260392692	41000CC	1.000	.375	N/A	100

TARGET MARKET SYMBOLS

● = Ceramics    ▲ = Tool & Die    ■ = Composites

Electroplated Mounted Points, Mandrels, Tapered Honers and Micro Drills

Diamond and cBN Mounted Points ● ▲

PART #	PRODUCT #	HEAD DIAMETER INCHES	HEAD LENGTH	GRIT SIZE
<b>6000 Series – Diamond</b>				
<b>3/8" Shank x 3-3/4" Overall Length</b>				
66260392694	6406CD	.406	.375	80
66260392693	6406MD	.406	.375	150
66260392698	6437CD	.437	.375	80
66260392697	6437MD	.437	.375	150
66260392702	6500CD	.500	.375	80
66260392701	6500MD	.500	.375	150
66260392706	6562CD	.562	.375	80
66260392710	6625CD	.625	.375	80
66260392709	6625MD	.625	.375	150
66260392718	6750CD	.750	.375	80
66260392717	6750MD	.750	.375	150
66260392721	6875MD	.875	.400	150
66260392726	61000CD	1.000	.500	80

PART #	PRODUCT #	HEAD DIAMETER INCHES	HEAD LENGTH	GRIT SIZE
<b>6000 Series – cBN</b>				
<b>3/8" Shank x 3-3/4" Overall Length</b>				
66260392696	6406CC	.406	.375	80
66260392695	6406MC	.406	.375	150
66260392700	6437CC	.437	.375	80
66260392699	6437MC	.437	.375	150
66260392703	6500CC	.500	.375	80
66260392704	6500MC	.500	.375	150
66260392708	6562CC	.562	.375	80
66260392712	6625CC	.625	.375	80
66260392716	6687CC	.687	.375	80
66260392715	6687MC	.687	.375	150
66260392720	6750CC	.750	.375	80
66260392719	6750MC	.750	.375	150
66260392724	6875CC	.875	.400	80
66260392728	61000CC	1.000	.500	80
66260392727	61000MC	1.000	.500	150

cBN Heavy Stock Removal Mandrels ▲

- For heavy stock removal on jig, internal, and offhand operations on tool steels and hardened aerospace alloys. Made with super coarse abrasive grit for long tool life

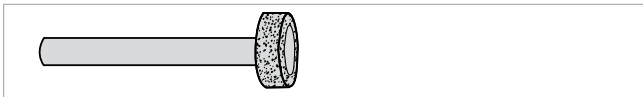

PART #	PRODUCT #	HEAD DIAMETER	HEAD LENGTH	SHANK DIAMETER	OVERALL LENGTH	GRIT SIZE
<b>HSR Series – cBN</b>						
66260395426	HSR-1/4	1/4	1/4	3/8	3	60
66260395428	HSR-3/8	3/8	3/8	3/8	3	60
66260395429	HSR-1/2	1/2	3/8	3/8	3-1/2	60
66260395431	HSR-3/4	3/4	3/8	3/8	3-1/2	60
66260395432	HSR-1	1	3/8	3/8	3-1/2	60

Diamond Tapered Honers for Drawing Dies ● ▲ ■

- Used primarily for forming carbide drawing dies, but also can be used for small hole honing in ceramics, fiberglass, plastics, and composite materials

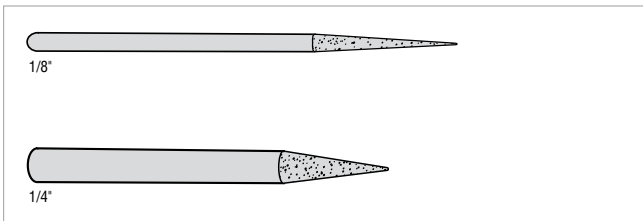

PART #	PRODUCT #	INCLUDED ANGLE	SHANK DIAMETER	GRIT SIZE
<b>Tapered Honers for Drawing Dies – Diamond</b>				
<b>3" Overall Length</b>				
66260395540	TH12-6MD	6°	1/8	150
66260395541	TH12-8MD	8°	1/8	150
66260393371	TH25-12CD	12°	1/4	100
66260395542	TH12-12MD	12°	1/8	150
66260395543	TH25-12MD	12°	1/4	150
66260395544	TH25-14MD	14°	1/4	150
66260395545	TH25-16MD	16°	1/4	150

Diamond Micro Drills ● ▲ ■

- A modification of mounted points, these tools are specifically designed for drilling holes in the .007" to .065" diameter range
- Perfect for drilling sapphire and high density alumina ceramics for hybrid micro-circuit substrates
- M-Series - Carefully-sized, uniformly-shaped diamond particles are used on all M-Series drills
- S-Series - Recommended for adapting to ultrasonic drill heads

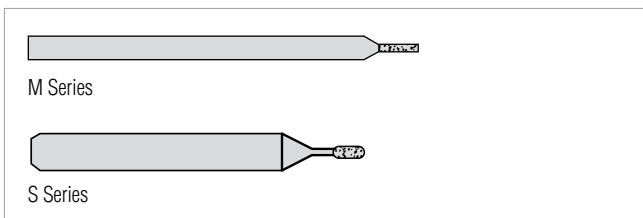

PART #	PRODUCT #	DIAMETER INCHES	HEAD LENGTH	OVERALL LENGTH	GRIT SIZE
<b>M-Series Micro Drills – Diamond</b>					
<b>Shank Diameter .040" (1mm)</b>					
66260395516	M7	.007	.028	11/16	600
66260395517	M10	.010	.049	11/16	400
66260395518	M12	.012	.056	13/16	325
66260395519	M15	.015	.077	13/16	325

PART #	PRODUCT #	DIAMETER INCHES	HEAD LENGTH	OVERALL LENGTH	GRIT SIZE
<b>S-Series Micro Drills – Diamond</b>					
<b>1/8" Shank x 1" Overall Length</b>					
66260395520	S16FD	.016	.062	.093	200
66260392841	S18FD	.018	.062	.125	200
66260395521	S20FD	.020	.062	.125	200
66260395522	S25FD	.025	.093	.156	200
66260395523	S30MD	.030	.093	.156	150
66260395524	S35MD	.035	.093	.187	150
66260395525	S40MD	.040	.125	.218	150
66260395526	S45CD	.045	.125	.218	100
66260395527	S50CD	.050	.125	.250	100
66260395528	S60CD	.060	.125	.312	100
66260395529	S65CD	.065	.125	.312	100

**TARGET MARKET SYMBOLS**  
● = Ceramics    ▲ = Tool & Die    ■ = Composites

**Electroplated Routers and Mounted Contour Tools**

**Diamond Routers** ● ■

- Used with hand operated tools, drill presses, and milling machines
- Ideal for routing and reaming the highly-abrasive materials of alumina, fiberglass, plastics, and other nonmetallic composite materials.

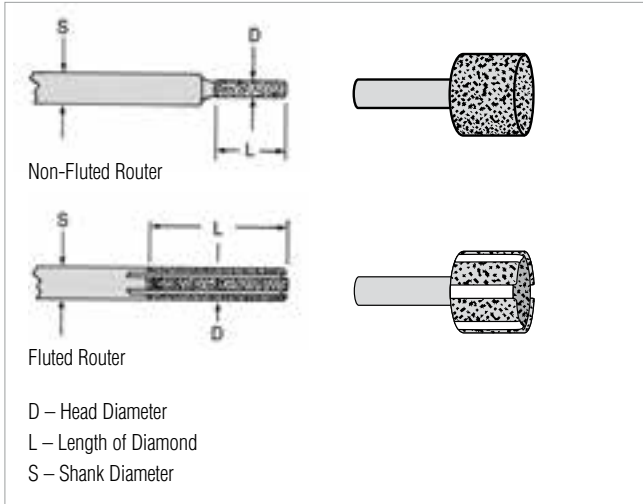

PART #	PRODUCT #	HEAD DIAMETER	LENGTH OF DIAMOND	SHANK DIAMETER	OVERALL LENGTH	GRIT SIZE
<b>Non-Fluted Routers – Diamond</b>						
662603 <b>64302</b>	RNF1410CD	1/4	1	1/4	2-1/2	40
<b>Fluted Routers – Diamond</b>						
662603 <b>64310</b>	RSF1812CD	1/8	1/2	1/4	2-1/2	60
662603 <b>64309</b>	RSF1810CD	1/8	1	1/4	2-1/2	60
662603 <b>64308</b>	RSF1412CD	1/4	1/2	1/4	2-1/2	40
662603 <b>64307</b>	RSF1410CD	1/4	1	1/4	2-1/2	40
662603 <b>02715</b>	RSF3412CD	3/4	1/2	1/2	2-1/2	40

Type 6A2C cup and Type 01 straight bench and pedestal electroplated wheels are available as made-to order products. Contact your Norton representative for availability and quotation.

**Diamond and cBN Mounted Contour Tools** ● ▲ ■

- For contour grinding applications on carbide, ceramics, glass, ferrites, and many tough alloys and cements. Best suited for blending radii and deburring operations
- Operating speeds: 15,000-20,000 RPM range
- Variety of tool shapes available as stock to satisfy most tool and die and deburring requirements

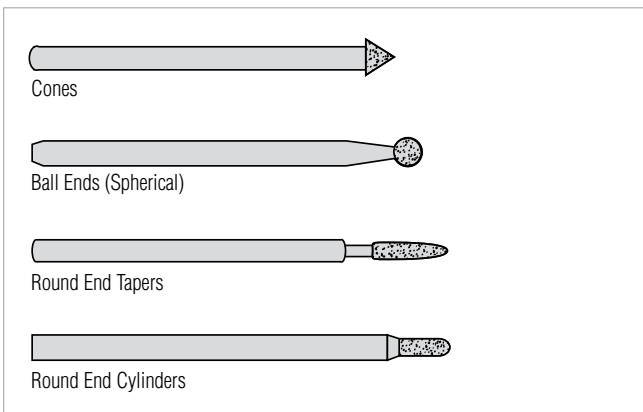

PART #	PRODUCT #	CONE BASE DIAMETER	INCLUDED ANGLE	CONE LENGTH	GRIT SIZE
<b>Cones – Diamond</b>					
<b>1/8" Shank x 2" Overall Length</b>					
662603 <b>95484</b>	C14CD	1/8	14°	1/2	100
662603 <b>95488</b>	C35CD	5/32	35°	1/4	100
662603 <b>95490</b>	C60CD	11/64	60°	5/32	100
662603 <b>95492</b>	C90CD	3/16	90°	3/32	100
<b>Cones – cBN</b>					
<b>1/8" Shank x 2" Overall Length</b>					
662603 <b>95483</b>	C14CC	1/8	14°	1/2	100
662603 <b>95485</b>	C26CC	3/16	26°	13/32	100
662603 <b>95487</b>	C35CC	5/32	35°	1/4	100
662603 <b>95489</b>	C60CC	11/64	60°	5/32	100
662603 <b>95491</b>	C90CC	3/16	90°	3/32	100

**TARGET MARKET SYMBOLS**

- = Ceramics
- ▲ = Tool & Die
- = Composites

PART #	PRODUCT #	BALL DIAMETER	GRIT SIZE
<b>Ball Ends (Spherical) – Diamond</b>			
<b>1/8" Shank x 2" Overall Length</b>			
662603 <b>95434</b>	BE1CD	3/64	100
662603 <b>95436</b>	BE2CD	1/16	100
662603 <b>95438</b>	BE3CD	5/64	100
662603 <b>95440</b>	BE4CD	3/32	100
662603 <b>95442</b>	BE5CD	1/8	100
662603 <b>95444</b>	BE6CD	3/16	100
662603 <b>95448</b>	BE8CD	3/8	100
662603 <b>95450</b>	BE9CD	1/2	100
<b>Ball Ends (Spherical) – cBN</b>			
<b>1/8" Shank x 2" Overall Length</b>			
662603 <b>95437</b>	BE3CC	5/64	100
662603 <b>95439</b>	BE4CC	3/32	100
662603 <b>95441</b>	BE5CC	1/8	100
662603 <b>95443</b>	BE6CC	3/16	100
662603 <b>95445</b>	BE7CC	1/4	100

PART #	PRODUCT #	SMALL HEAD DIAMETER	LARGE HEAD DIAMETER	HEAD LENGTH	INC. ANGLE	GRIT SIZE
<b>Round End Tapers – Diamond</b>						
<b>1/8" Shank x 2" Overall Length</b>						
662603 <b>95506</b>	RT44CD	.044	.066	5/16	4°	100
662603 <b>95510</b>	RT78CD	.078	.110	5/16	6°	100
<b>Round End Tapers – cBN</b>						
<b>1/8" Shank x 2" Overall Length</b>						
662603 <b>95509</b>	RT78CC	.078	.110	5/16	6°	100

PART #	PRODUCT #	HEAD DIAMETER	HEAD LENGTH	GRIT SIZE
<b>Round End Cylinders – Diamond</b>				
<b>1/8" Shank x 2" Overall Length</b>				
662603 <b>95494</b>	RE1CD	1/16	1/4	100
662603 <b>95496</b>	RE2CD	5/64	1/4	100
662603 <b>95498</b>	RE3CD	3/32	1/4	100
662603 <b>95500</b>	RE4CD	1/8	1/4	100
662603 <b>95502</b>	RE5CD	3/16	5/16	100
662603 <b>95504</b>	RE6CD	1/4	5/16	100

## Electroplated Files

### Diamond Machine Files ● ▲

- For use in reciprocating hand profiling machines
- Ideal for reworking and finishing carbide dies and molds, blending radii, and deburring and cleaning slots and grooves

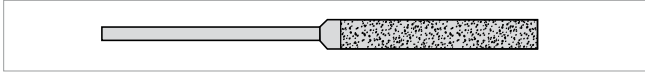

### Diamond Hand Files ● ▲

- Indispensable aid for the toolroom
- All purpose hand-held tool useful for deburring, notching, dressing, and honing hard, brittle materials

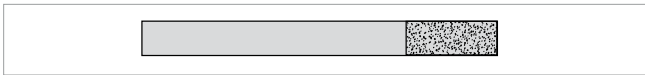

PART #	PRODUCT #	DIMENSIONS	ABRASIVE LOCATION	GRIT SIZE
<b>Machine Files – Diamond</b>				
<b>5/8" Diamond Length, 1/8" Shank, 2" Overall Length</b>				
662603 <b>95585</b>	1ECD	.020 x .125		100
662603 <b>95586</b>	2ECD	.030 x .125		100
662603 <b>95587</b>	3ECD	.040 x .125		100
662603 <b>95589</b>	3FCD	.120 x .040		100
662603 <b>95590</b>	4FCD	.157 x .040		100
662603 <b>95591</b>	5FCD	.203 x .078		100
662603 <b>95592</b>	6FCD	.120 x .040		100
662603 <b>95593</b>	1CCD	.098 x .196		100
662603 <b>95594</b>	2CCD	.120 x .250		100
662603 <b>95596</b>	3TCD	.127 side		100
662603 <b>95598</b>	1RCD	.042 diam.		100
662603 <b>95599</b>	2RCD	.080 diam.		100
662603 <b>95600</b>	3RCD	.127 diam.		100

PART #	PRODUCT #	DIMENSIONS	ABRASIVE LOCATION	GRIT SIZE
<b>Hand Files – Diamond</b>				
<b>6" Overall Length, 1-1/2" Diamond Length</b>				
662603 <b>95605</b>	DF1CD	1/8 x 1/8		100
662603 <b>95606</b>	DF2CD	1/8 x 1/4		100
662603 <b>95607</b>	DF2WCD	1/8 x 1/4		100
662603 <b>95608</b>	DF3CD	1/8 x 3/8		100
662603 <b>92844</b>	DF3FD	1/8 x 3/8		200
662603 <b>95609</b>	DF3WCD	1/8 x 3/8		100
662603 <b>64241</b>	DF3SCD	1/8 x 1/2		100
662603 <b>95611</b>	DF4CD	1/8		100
662603 <b>00134</b>	DF4WCD	1/4		100
662603 <b>95613</b>	DF5CD	1/8		100
662603 <b>92846</b>	DF5FD	1/8		200
662603 <b>95614</b>	DF5WCD	1/4		100
662603 <b>95615</b>	DF6CD	1/8		100

**TARGET MARKET SYMBOLS**

- = Ceramics      ▲ = Tool & Die      ■ = Composites

## Electroplated Files and Drills

### Diamond Needle Files ● ▲

- Indispensable aid for the toolroom
- An all-purpose hand-held tool, useful for deburring, notching, dressing, and honing hard, brittle materials

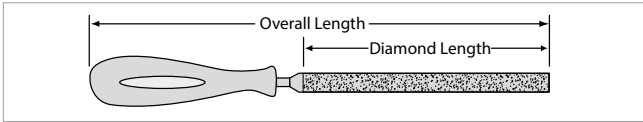

PART #	PRODUCT #	GRIT SIZE
<b>NFK-6 Needle File Kit – Diamond</b>		
662603 <b>64008</b>	NFK-6	
<b>Contains one each of the following:</b>		
	NF1FD	200
	NF2FD	200
	NF3FD	200
	NF4FD	200
	NF5FD	200
	NF6FD	200
<b>DFS-6 Die File Kit – Diamond</b>		
662603 <b>91830</b>	DFS-6	
<b>Contains one each of the following:</b>		
	1571	100
	1572	100
	1573	100
	1574	100
	1575	100
	1576	100

PART #	PRODUCT #	DIMENSIONS	ABRASIVE LOCATION	SHAPE	GRIT SIZE
<b>Needle Files – Diamond</b>					
<b>4-1/4" Diamond Length, 8-1/2" Overall Length</b>					
662603 <b>02432</b>	LNF2CD	.400 x .100		Equaling	100
662603 <b>05611</b>	LNF2FD	.400 x .100		Equaling	200
662603 <b>02898</b>	LNF3CD	.450 x .150		Half Round	100
662603 <b>05612</b>	LNF3FD	.485 x .150		Half Round	200
<b>2-3/4" Diamond Length, 5-3/4" Overall Length, With Handle</b>					
662603 <b>91729</b>	1571	.055 x .190		Flat	100
662603 <b>91730</b>	1572	.075 x .210		Half Round	100
662603 <b>91731</b>	1573	.145 x .145		Triangle	100
662603 <b>91732</b>	1574	.100 x .100		Square	100
662603 <b>91733</b>	1575	.120		Round	100
662603 <b>91734</b>	1576	.055 x .190		Pointed Flat	100
<b>3" Diamond Length, 5-1/2" Overall Length, With Handle</b>					
662603 <b>95575</b>	NF1FD	.150 x .105		Oval	200
662603 <b>95576</b>	NF2FD	.218 x .072		Half Round	200
662603 <b>95577</b>	NF3FD	.205 x .058		Equaling	200
662603 <b>95578</b>	NF4FD	.096 x .096		Square	200
662603 <b>95579</b>	NF5FD	.138 x .138		Triangle	200
662603 <b>95580</b>	NF6FD	.118		Round	200

### Needle File Shape and Application Key:

Barrette:	A triangle with diamond on the bottom side only
Crossing:	Elongated oval, with more pointed ends than an oval file; has diamonds all around
Equaling:	A rectangle with diamond on all four sides; ideal for filing both sides of an ID simultaneously
Pointed Flat:	A cone with a flat top with diamond on the sides of the cone

### Diamond Core Drills ● ■

- High performance on glass and ceramic applications while providing fast, reliable cutting
- Submersed drilling is highly recommended for optimum operating performance



PART #	PRODUCT #	OUTER DIAMETER	INNER DIAMETER	GRIT SIZE
<b>Core Drills – Diamond</b>				
<b>Straight Tube Type, 2" Overall Length</b>				
662603 <b>95530</b>	A1MD	1/16	.023	150
662603 <b>95531</b>	A2MD	3/32	.048	150
662603 <b>95532</b>	A3MD	1/8	.075	150
662603 <b>95533</b>	A4MD	5/32	.110	150
662603 <b>95534</b>	A5CD	3/16	.140	100
662603 <b>95535</b>	A6CD	1/4	.195	100
662603 <b>95536</b>	A7CD	5/16	.255	100

### Diamond Twist Drills ● ■

- Recommended for precision drilling on circuit boards containing fiberglass, nylon, and similar tough, abrasive materials
- Diamond twist drills are also useful for drilling plastics and resin composites and have been successful in drilling soft ductile materials as well as "green" carbide
- Operating procedures are similar to those of standard twist drills

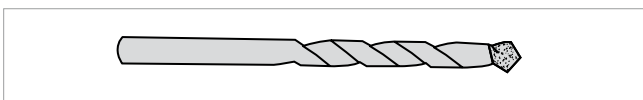

PART #	PRODUCT #	DRILL DIAMETER	DRILL LENGTH	GRIT SIZE
<b>Twist Drills – Diamond</b>				
662603 <b>95549</b>	TW-1/16	1/16	1-3/4	100
662603 <b>95550</b>	TW-1/8	1/8	2-3/4	100
662603 <b>95551</b>	TW-1/4	1/4	4	100

*Diameter tolerance equals + or - 1/64.*

#### TARGET MARKET SYMBOLS

- = Ceramics
- ▲ = Tool & Die
- = Composites



## Electroplated Saw Blades

### Diamond Continuous Rim Cut-off Saw Blades ■

- Ideal for cutting-off highly-abrasive materials such as alumina, fiberglass, plastics, and other nonmetallic composite materials

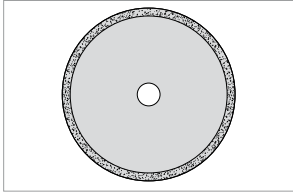

Additional diamond continuous rim and slotted cut-off saw blades, with extended wraps to avoid binding, are available as made-to-order products. Please contact your Norton representative.

### Diamond Slotted Cut-off Saw Blades ■

- 3/4" wrap: additional 3/4" of electroplated diamond on the blade core increases life of blade on deep cuts, and reduces binding and grinding on the core

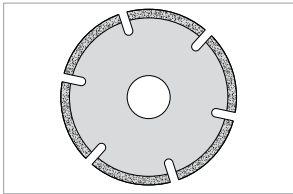

Additional diamond continuous rim and slotted cut-off saw blades, with extended wraps to avoid binding, are available as made-to-order products. Please contact your Norton representative.

### Diamond Mounted Saw Blades ■

- Ideal for cutting-off highly-abrasive materials such as alumina, fiberglass, plastics, and other nonmetallic composite materials
- 3/4" wrap - additional 3/4" of electroplated diamond on the blade core increases life of blade on deep cuts, and reduces binding and grinding on the core

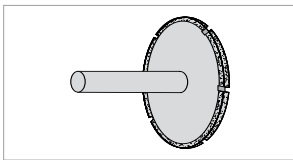

PART #	PRODUCT #	DIAM.	OVERALL THICKNESS	HOLE SIZE	GRIT SIZE
<b>Continuous Rim Cut-off Saw Blades – Diamond</b>					
662603 <b>01990</b>	DS2062-250	2	1/16	1/4	40
662603 <b>91474</b>	DS2094-250	2	3/32	1/4	40
662603 <b>91473</b>	DS3094-250	3	3/32	1/4	40
662603 <b>63036</b>	DS3094-375	3	3/32	3/8	40
662603 <b>95554</b>	DS4094-500	4	3/32	1/2	40
662603 <b>00197</b>	DS4094-750	4	3/32	3/4	40
662603 <b>95557</b>	DS8094-625	8	3/32	5/8	40

PART #	PRODUCT #	DIAM.	OVERALL THICKNESS	HOLE SIZE	GRIT SIZE
<b>Slotted Cut-off Saw Blades – Diamond</b>					
662603 <b>01989</b>	DSS2062-250	2	1/16	1/4	40
662603 <b>64258</b>	DSS3094-250	3	3/32	1/4	40
662603 <b>95559</b>	DSS4094-500	4	3/32	1/2	40
662603 <b>95560</b>	DSS6094-500	6	3/32	1/2	40
662603 <b>62981</b>	DSS10125-625	10	1/8	5/8	40
662603 <b>64253</b>	DSS14156-500	14	5/32	1/2	40
662603 <b>62989</b>	DSS14156-1	14	5/32	1	40
662603 <b>95565</b>	DSS16156-1	16	5/32	1	40
662603 <b>95566</b>	DSS18156-1	18	5/32	1	40
<b>Slotted Cut-off Saw Blades with 3/4" Wrap – Diamond</b>					
662603 <b>13423</b>	DSSW4094-750	4	3/32	3/4	40

PART #	PRODUCT #	DIAM.	OVERALL THICKNESS	HOLE SIZE	GRIT SIZE
<b>Mounted Saw Blades – Diamond</b>					
<b>2" Overall Length</b>					
662603 <b>95422</b>	MDS1CD	1	3/32	1/4	40
662603 <b>95423</b>	MDS1-1/2CD	1-1/2	3/32	1/4	40
662603 <b>95424</b>	MDS2CD	2	3/32	3/8	40

**TARGET MARKET SYMBOLS**

- = Ceramics
- ▲ = Tool & Die
- = Composites



Norton Winter diamond lapping compound polishes all materials – hard and soft. Diamond powders are uniformly distributed in a liquid vehicle for aggressive polishing and consistent part quality. Easy-to-use plastic syringe for quick clean-up.

**Applications:**

For mold, die, and tool polishing, polishing to final tolerance of ceramic parts, initial charging of lapping plates and discs, and other processes that require mirror finish and close tolerance performance.

**Syringe Size:**  
**Type:**

5 and 18 gram syringes  
Water soluble – when soap/water is used for clean-up  
Oil soluble – when solvent is used for clean-up

PRODUCT #	MICRON GRADE	COLOR	PART #
<b>Diamond Compound – Water Soluble</b>			
<b>5 Gram Syringes</b>			
5PS1/4WSSTD	1/4 Ultra Fine	Gray	662603 <b>00362</b>
5PS1/2WSSTD	1/2 Ultra Fine	Lt. Gray	662603 <b>00417</b>
5PS1WSSTD	1 Ultra Fine	Ivory	662603 <b>00368</b>
5PS3WSSTD	3 Super Fine	Yellow	662603 <b>00667</b>
5PS6WSSTD	6 Super Fine	Orange	662603 <b>00372</b>
5PS9WSSTD	9 Super Fine	Green	662603 <b>00375</b>
5PS12WSSTD	12 Super Fine	Aqua	662603 <b>00376</b>
5PS15WSSTD	15 Fine	Blue	662603 <b>00379</b>
5PS30WSSTD	30 Fine	Red	662603 <b>00383</b>
5PS45WSSTD	45 Fine	Brown	662603 <b>00384</b>
5PS60WSSTD	60 Fine	Purple	662603 <b>00388</b>
5PS90WSSTD	90 Fine	Black	662603 <b>00389</b>
<b>18 Gram Syringes</b>			
18PS1/4WSSTD	1/4 Ultra Fine	Gray	662603 <b>00392</b>
18PS1/2WSSTD	1/2 Ultra Fine	Lt. Gray	662603 <b>00394</b>
18PS1WSSTD	1 Ultra Fine	Ivory	662603 <b>00396</b>
18PS3WSSTD	3 Super Fine	Yellow	662603 <b>00398</b>
18PS6WSSTD	6 Super Fine	Orange	662603 <b>00400</b>
18PS9WSSTD	9 Super Fine	Green	662603 <b>00402</b>
18PS15WSSTD	15 Fine	Blue	662603 <b>00406</b>
18PS20WSSTD	20 Fine	Auburn	662603 <b>00408</b>

PRODUCT #	MICRON GRADE	COLOR	PART #
<b>Diamond Compound – Oil Soluble</b>			
<b>5 Gram Syringes</b>			
5PS1/4OSSTD	1/4 UltraFine	Gray	614636 <b>91123 NS</b>
5PS1/2OSSTD	1/2 UltraFine	Lt. Gray	662603 <b>00363</b>
5PS1OSSTD	1 UltraFine	Ivory	614636 <b>91133</b>
5PS3OSSTD	3 Super Fine	Yellow	614636 <b>91138</b>
5PS6OSSTD	6 Super Fine	Orange	614636 <b>91143</b>
5PS9OSSTD	9 Super Fine	Green	614636 <b>91148</b>
5PS15OSSTD	15 Fine	Blue	614636 <b>91153</b>
5PS30OSSTD	30 Fine	Red	614636 <b>91158</b>
5PS45OSSTD	45 Fine	Brown	614636 <b>91163</b>
5PS60OSSTD	60 Fine	Purple	662603 <b>00386</b>
5PS90OSSTD	90 Fine	Black	662603 <b>00390</b>
<b>18 Gram Syringes</b>			
18PS1/4OSSTD	1/4 UltraFine	Gray	662603 <b>00391</b>
18PS1OSSTD	1 UltraFine	Ivory	614636 <b>91134 NS</b>
18PS3OSSTD	3 Super Fine	Yellow	614636 <b>91139</b>
18PS6OSSTD	6 Super Fine	Orange	662603 <b>00399</b>
18PS9OSSTD	9 Super Fine	Green	614636 <b>91149 NS</b>
18PS15OSSTD	15 Fine	Blue	614636 <b>91154</b>
18PS20OSSTD	20 Fine	Auburn	662603 <b>00407</b>
18PS30OSSTD	30 Fine	Red	662603 <b>00409</b>
18PS45OSSTD	45 Fine	Brown	614636 <b>91164 NS</b>
18PS60OSSTD	60 Fine	Purple	662603 <b>00413</b>
18PS90OSSTD	90 Fine	Black	662603 <b>00415</b>

*NS Non-stock; contact your Norton representative for current lead-times.*

**Marking System**

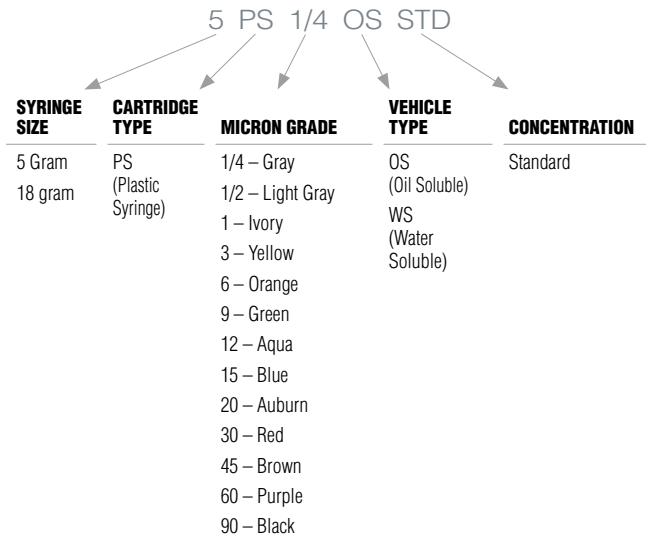

**TECH TIP**

**Diamond Compound Application Guide**

APPLICATION	MICRON GRADE	MICRON RANGE	MESH SIZE EQUIV.	COLOR	CONC.
<b>ULTRA FINE</b> Applying finest finishes on metals and ceramics	1/4	(0-1/2)	100,000	Gray	Std.
	1/2	(0-1)	60,000	Lt. Gray	Std.
	1	(0-2)	14,000	Ivory	Std.
<b>SUPER FINE</b> Final finishing of dies, molds, seals, most applications (RMS 4-12)	3	(2-4)	8,000	Yellow	Std.
	6	(4-8)	3,000	Orange	Std.
	9	(8-12)	1,800	Green	Std.
	12	(9-15)	1,500	Aqua	Std.
<b>FINE FINISH</b> Preparatory lapping (RMS 12-20)	15	(12-22)	1,200	Blue	Std.
	20	(15-25)	800	Auburn	Std.
	30	(22-36)	600	Red	Std.
	45	(36-45)	325	Brown	Std.
	60	(54-80)	230	Purple	Std.
	90	(80-100)	170	Black	Std.

## the Norton Clipper brand **HITS THE PAVEMENT**

The leader for diamond blades, tools, and light machines for construction and cutting materials is “Redefining Jobsite Muscle – Rugged. Reliable. Affordable.”





With faster cut rates, constant depth of cut, and less downtime, Norton Clipper diamond blades are the choice of professionals versus conventional abrasive blades. Norton Clipper diamond blades are available for high-speed saws, portable hand-held saws, and walk-behind saws. For the full offering of diamond blades, see the Norton Clipper Construction Products Catalog #7719.

- Applications:** Cutting concrete, stone, tile, and other building materials
- Size Range:** 4" – 18"
- Thickness Range:** .080" – .375"
- Segment Height Range:** .210" – .550"
- Abrasive Grain:** Diamond
- Mounting Options:** 1"/20mm universal arbor, 7/8"-5/8"-20mm, DM-7/8"-5/8", 5/8"-11
- Shape:** Type 01
- Machines Used:**



HIGH-SPEED GAS OR ELECTRIC SAW



CIRCULAR SAW



RIGHT-ANGLE GRINDER



WALK-BEHIND SAW

### Diamond Blade Rim Types

There are three main diamond blade rim types: segmented, turbo, and continuous rim.

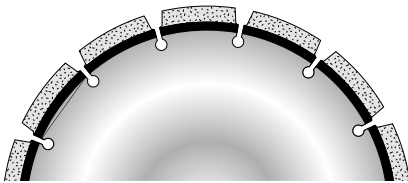

#### Segmented

- Most aggressive cutting action for general-purpose and masonry applications
- Use when cutting speed and productivity are more important than finish
- Best life, best cut rate, good finish

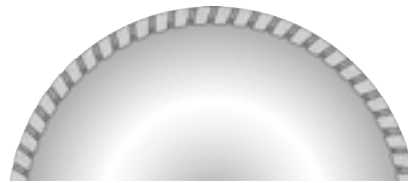

#### Turbo

- Aggressive cutting action with a smoother quality of cut than segmented rim blades
- For use on harder materials, such as granite, marble, and stone to reduce chipping
- Better life and cut rate, better finish

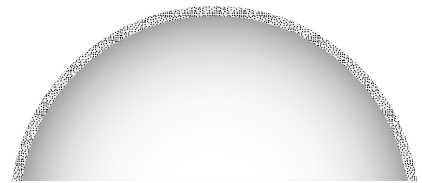

#### Continuous

- Provides the smoothest of cuts
- Best performance when used wet
- Use on porcelain, tile, marble, and other hard materials requiring a high-quality cut
- Good life, good cut rate, best finish

### Material / Application-to-Product Recommendation Guide

Icon	Description	Application
	Multi-Purpose, All Materials	Concrete, reinforced concrete, granite, building materials, thin steel sections, angle iron up to 1/2" material thickness, rebar up to no. 5.
	Natural Stone and Tiles	Ceramic and stone tiles, granite, marble, very hard bricks and other very hard and dense materials.
	Reinforced Concrete and Harder Building Materials	Reinforced concrete, hard bricks, limestone, terrazzo, and other hard materials.
	General Purpose and Masonry Building Materials	Blocks, medium-hard building bricks, paving slabs, concrete roof tiles and other medium-hard materials.
	Asphalt	Asphalt, green concrete, asphalt over concrete, abrasive blocks, mortar and other abrasive materials.

### Diamond Performance Tiers

- 5 **Best**  
Best Performance
- 4 **Better**  
High Performance
- 3 **Value and Good**  
Consistent Performance
- 2
- 1

### TECH TIP

- Never twist or turn a segmented blade in the cut because it may result in segment breakage
- Never use wet blades dry
- Remove dry blades from cut for 10 seconds of each minute of cut to air cool
- Never operate any saw, wet or dry, without the blade guard



It is the user's responsibility to refer to and comply with ANSI B7.1

### For Reinforced Concrete and Harder Building Materials

DRY – Segmented Rim +

DUO EVO				
The unique shape of the DUO EVO segments optimizes the angle of attack while enhancing the evacuation of the debris. With a new manufacturing process, the DUO EVO segments provide an exceptional cutting speed for optimum performance and increased life up to 20% over the original DUO EVO design.				
SIZE (D x T x H)	SEGMENT HEIGHT	MAX RPM	PART #	UPC #
12 x .110 x 1"/20mm	.590"	6,300	DUOEVO12110	701846 <b>84217</b>
14 x .118 x 1"/20mm	.590"	5,460	DUOEVO14118	701846 <b>84218</b>
16 x .125 x 1"/20mm	.590"	4,500	DUOEVO16125	701846 <b>93356</b>



DUO				
Our exclusive design has become a dominant name in the market. The unique dual segment per land technology provides excellent cutting speed with low vibration and high comfort of cut. The exclusive arrow shape gullets not only indicate blade direction, but also assist in fast removal of cutting debris. Maximum general purpose performance when cutting medium to low reinforcement, hard materials.				
SIZE (D x T x H)	SEGMENT HEIGHT	MAX RPM	PART #	UPC #
12 x .110 x 1/20mm	.393"	6,300	DUO12110	701846 <b>83611</b>
14 x .110 x 1/20mm	.393"	5,460	DUO14110	701846 <b>83612</b>
14 x .110 x 1/20mm	.393"	5,460	DUO14110 6PK	701846 <b>84430</b>
14 x .110 x 1/20mm	.393"	5,460	DUO14110 12PK	701846 <b>84431</b>
14 x .125 x 1/20mm	.393"	5,460	DUO14125	701846 <b>83613</b>
14 x .125 x 1/20mm	.393"	5,460	DUO14125 6PK	701846 <b>84432</b>
14 x .125 x 1/20mm	.393"	5,460	DUO14125 12PK	701846 <b>84433</b>
16 x .125 x 1/20mm	.393"	4,500	DUO16125	701846 <b>83798</b>



### For Asphalt and Abrasive Materials

DRY – Segmented Rim +

DUO ASPHALT				
Dry cutting laser-welded blade for asphalt and green concrete. The laser-welded, wear-retardant drop segments extend blade life. Scoop gullets for faster swarf removal increases cut speed. Stroboscopic indicators to control cut depth and show rotation direction.				
SIZE (D x T x H)	SEGMENT HEIGHT	MAX RPM	PART #	UPC #
12 x .110 x 1/20mm	.393"	6,300	DUOASP12125	701846 <b>84543</b>
14 x .125 x 1/20mm	.393"	5,460	DUOASP14125	701846 <b>84315</b>
16 x .125 x 1/20mm	.393"	4,500	DUOASP16125	701846 <b>84544</b>



DUO ABRASIVE				
Utilizes the basic characteristics of the original DUO blade and adds a unique segment shape that optimizes the angle of attack while enhancing the evacuation of the particles. The result is an exceptional cutting speed allied with very good performance and life in abrasive materials and concrete block. The bond specification lends additional life when high-speed cutting.				
SIZE (D x T x H)	SEGMENT HEIGHT	MAX RPM	PART #	UPC #
14 x .110 x 1/20mm	.393"	5,460	DUOAB14110	701846 <b>84291</b>
14 x .125 x 1/20mm	.393"	5,460	DUOAB14125	701846 <b>84292</b>



### For General-Purpose and Masonry Building Materials

DRY – Segmented Rim +

CLASSIC				
The improved bond provides longer life at an economical price in medium-hard materials such as concrete with light to medium reinforcement.				
SIZE (D x T x H)	SEGMENT HEIGHT	MAX RPM	PART #	UPC #
12 x .110 x 1/20mm	.314"	6,300	COHSGP1220	701846 <b>81383</b>
14 x .110 x 1/20mm	.275"	5,460	COHSGP1420	701846 <b>81309</b>
14 x .125 x 1/20mm	.314"	5,460	COHSGP1420P	701846 <b>84268</b>
16 x .125 x 1/20mm	.259"	4,500	COHSGP1620	701846 <b>40356</b>



VALUPLUS				
For value and performance on small- to medium-size jobs. The sintered blade cuts unreinforced soft-to-medium concrete fast on saws up to 13 HP.				
SIZE (D x T x H)	SEGMENT HEIGHT	MAX RPM	PART #	UPC #
12 x .110 x 1/20mm	.393"	6,300	VPHSGP1220	701846 <b>84180</b>
14 x .110 x 1/20mm	.393"	5,460	VPHSGP1420	701846 <b>84181</b>
14 x .110 x 1/20mm	.393"	5,460	VPHSGP1420 20PK	701846 <b>84428</b>



## Multi-Purpose, For All Materials

Dry – Segmented Rim  + 



### 4X4 MAX CUT

Taking high-speed cutting versatility to an all new level. The same standard features as the 4X4 with its anti-crack gullets and patented depth indicators that not only cool the blade, but also allow the operator to know how deep they are cutting. An all-new bond and diamond specification improves blade life in a wide range of materials while excelling in steel. New segment wear indicators give the operator an idea of remaining blade life.

SIZE (D x T x H)	SEGMENT HEIGHT	MAX RPM	PART #	UPC #
12 x .118 x 1/20mm	.472"	6,300	4X4MC12118	701846 <b>45927</b>
14 x .125 x 1/20mm	.472"	5,460	4X4MC14125	701846 <b>45926</b>



### 4X4

Multi-purpose laser welded blade for dry cutting a range of construction materials without sacrificing performance or price. Depth of cut is easily controlled with the patented depth-of-cut indicators cut into the steel core. Anti-crack gullets for enhanced safety cutting steel and metal (up to 5mm thick).

SIZE (D x T x H)	SEGMENT HEIGHT	MAX RPM	PART #	UPC #
12 x .110 x 1/20mm	.393"	6,300	4X412110	701846 <b>84548</b>
14 x .125 x 1/20mm	.393"	5,460	4X414125	701846 <b>84547</b>
16 x .125 x 1/20mm	.393"	4,500	4X416125	701846 <b>45306</b>



### 3X3

It's everything expected for high-speed cutting when both performance and price are a factor. The laser welded 3X3 cuts concrete, reinforced concrete, asphalt and abrasive building materials and more. High quality diamond increases the speed of cut on a variety of materials without changing blades. Premium blade characteristics and price point that would normally take multiple sintered blades to achieve.

SIZE (D x T x H)	SEGMENT HEIGHT	MAX RPM	PART #	UPC #
12 x .118 x 1/20mm	.314"	6,300	3X312118	701846 <b>47500</b>
14 x .118 x 1/20mm	.314"	5,460	3X314118	701846 <b>47499</b>



## TECH TIP

High-Speed Hand Saw Blades –  
Maximum Blade Cutting Depths and  
Recommended Operating Speeds

Note: Diamond blade cutting depths listed are approximate. Actual cutting depth will vary with the exact blade diameter or saw type, or the exact diameter of the blade flanges. Cutting depth will also be reduced if saw components extend below the blade flanges.





BLADE DIAMETER	CUTTING DEPTH	MAXIMUM SPEED (RPM)
12"	4"	6,300
14"	5"	5,460
16"	6"	4,500



It is the user's responsibility to refer to and comply with ANSI B7.1

## For Reinforced Concrete and Harder Building Materials



DRY – Crack Chasing  + 

CHARGER    				
A heavy V-shaped segment designed with a special bond and diamond content for maximum removal of grout, mortar jointing, crack chasing and crack widening. Fast cutting and long life in abrasive materials using portable tools. Highly competitive to others of its kind in the market.				
SIZE (D x T x H)	SEGMENT HEIGHT	MAX RPM	PART #	UPC #
4 x .375 x 7/8-5/8-20mm	.550"	15,000	CGCC0400	701846 <b>83856</b>
7 x .250 x 7/8-5/8-20mm	.550"	8,730	CGCC0700	701846 <b>83859</b>



## For Asphalt and Abrasive Materials





Dry – Tuck Pointing  + 

CLASSIC   				
An economical solution for small to medium tuck pointing jobs. High-quality performance for heavy grout removal or mortar jointing. The heavy-duty wide segment reduces wear in abrasive materials.				
SIZE (D x T x H)	SEGMENT HEIGHT	MAX RPM	PART #	UPC #
4 x .250 x 7/8-5/8	.275"	15,000	CHTUCK0400	701846 <b>81776</b>
4-1/2 x .250 x 7/8-5/8	.275"	13,300	CHTUCK0450	701846 <b>81777</b>
5 x .250 x 7/8-5/8	.275"	12,225	CHTUCK0500	701846 <b>81778</b>
7 x .250 x 7/8-5/8	.275"	8,730	CHTUCK0700	701846 <b>81779</b>
8 x .250 x 7/8-5/8	.275"	7,640	CHTUCK0800	701846 <b>81780</b>





## For General-Purpose and Masonry Building Materials

Dry – Segmented Rim  + 





CHARGER    				
High-performance dry cutting of a variety of materials. The segment specification allows extended life and fast cut for medium to large jobs.				
SIZE (D x T x H)	SEGMENT HEIGHT	MAX RPM	PART #	UPC #
4 x .080 x 7/8-5/8-20mm	.393"	15,000	CGDSEG0400	701846 <b>81505</b>
4-1/2 x .080 x 7/8-5/8-20mm	.393"	13,300	CGDSEG0450	076607 <b>04021</b>
5 x .080 x 7/8-5/8-20mm	.393"	12,225	CGDSEG0500	701846 <b>82851</b>
6 x .080 x 7/8-5/8-20mm	.393"	10,185	CGDSEG0600	701846 <b>83820</b>
7 x .090 x DM-7/8-5/8	.393"	8,730	CGDSEG0700	076607 <b>04020</b>
8 x .090 x DM-7/8-5/8	.393"	7,640	CGDSEG0800	701846 <b>81513</b>
9 x .090 x 7/8-5/8"	.393"	6,600	CGDSEG0900	701846 <b>69483</b>



VALUPLUS  				
For value and performance on small- to medium-size jobs cutting soft abrasive materials like brick and tile. The sintered rim delivers a quality cut and good life.				
SIZE (D x T x H)	SEGMENT HEIGHT	MAX RPM	PART #	UPC #
4 x .080 x 7/8-5/8-20mm	.315"	15,000	VPSEG0400	701846 <b>84098</b>
4-1/2 x .080 x 7/8-5/8-20mm	.315"	13,300	VPSEG0450	701846 <b>84099</b>
7 x .090 x DM-7/8-5/8	.315"	8,730	VPSEG0700	701846 <b>84100</b>





Dry – Turbo Rim  + 

CHARGER    				
Combines the characteristics of a standard Charger blade with a turbo rim configuration for cutting hard, dense materials with minimal effort. A better bond and diamond concentration for maximum cutting speed, life and quality of cut.				
SIZE (D x T x H)	SEGMENT HEIGHT	MAX RPM	PART #	UPC #
4 x .080 x 7/8-5/8-20mm	.393"	15,000	CGTURB0400	076607 <b>05475</b>
4-1/2 x .080 x 7/8-5/8-20mm	.393"	13,300	CGTURB0450	076607 <b>04023</b>
5 x .080 x 7/8-5/8-20mm	.393"	12,225	CGTURB0500	701846 <b>82853</b>
7 x .090 x DM-7/8-5/8	.393"	8,730	CGTURB0700	076607 <b>04022</b>
8 x .090 x DM-7/8-5/8	.393"	7,640	CGTURB0800	701846 <b>81512</b>



## For Natural Stone and Tiles

Dry – Continuous Rim  + 

CLASSIC   				
An economical solution for small- to medium-size jobs cutting softer ceramic tile and stone materials with efficient cutting ability.				
SIZE (D x T x H)	SEGMENT HEIGHT	MAX RPM	PART #	UPC #
4 x .080 x 7/8-5/8-20mm	.275"	15,000	CON4DT	076607 <b>02793</b>
4-1/2 x .080 x 7/8-5/8-20mm	.275"	13,300	CON45DT	076607 <b>01194</b>
7 x .090 x DM-7/8-5/8	.275"	8,730	CON7DT	076607 <b>02788</b>



For Reinforced Concrete and Harder Building Materials

WET – Medium Aggregates

CHARGER					
The steel core is designed to keep the cut straight while the .410" segment height prolongs cutting wear. Suitable for cutting medium aggregates with up to 35 HP walk-behind saws.					
SIZE (D x T x H)	SEGMENT HEIGHT	MAX RPM	POWER	PART #	UPC #
14 x .125 x 1	.410"	4,365	35hp	CGWCMD1412	70184681366
18 x .125 x 1	.410"	3,395	35hp	CGWCMD1812	70184681368

CLASSIC					
Laser welded blade at an economical price for general purpose cutting of cured concrete, medium-hard aggregate and no steel reinforcement. The bond and diamond combination allow fast cutting action on limited horse powered walk-behind saws.					
SIZE (D x T x H)	SEGMENT HEIGHT	MAX RPM	POWER	PART #	UPC #
14 x .125 x 1	.326"	4,365	35hp	CHWCGP1412	70184681359
18 x .125 x 1	.326"	3,395	35hp	CHWCGP1812	70184681361



For Asphalt and Abrasive Materials

DRY – Green/Cured Concrete

GMAX – MULTI-PURPOSE					
Designed specifically for our GC55/GC25E down-cut green concrete push saw, the GMAX Multi-Purpose blade is excellent in both green and cured concrete. The unique segment specification and anchor slot gullets allow this blade to be used in a variety of applications with outstanding results.					
SIZE (D x T x H)	SEGMENT HEIGHT	MAX RPM	POWER	PART #	UPC #
8 x .095 x 7/8-5/8	.372"	8,730	6hp	NXDGRN0895	70184683758
9 x .110 x 7/8-5/8	.372"	6,600	6hp	EE9110	70184675125
10 x .110 x 1-7/8-5/8	.372"	6,115	6hp	EE10110	70184684508



WET – Asphalt

CHARGER					
For large road and construction jobs with saws up to 35 HP. Higher diamond content increases productivity and offers faster cutting and longer life in asphalt and green concrete applications.					
SIZE (D x T x H)	SEGMENT HEIGHT	MAX RPM	POWER	PART #	UPC #
14 x .125 x 1	.327"	4,365	35hp	CGWASP1412	70184681478
18 x .125 x 1	.307"	3,395	35hp	CGWASP1812	70184681479

CLASSIC					
An economical choice for fast cutting and good life when performing jobs in a variety of abrasive materials such as green concrete and asphalt on saws up to 35 HP.					
SIZE (D x T x H)	SEGMENT HEIGHT	MAX RPM	POWER	PART #	UPC #
14 x .125 x 1	.326"	4,365	35hp	CHWASP1412	70184681375
18 x .125 x 1	.326"	3,395	35hp	CHWASP1812	70184681376



TECH TIP

Walk-Behind Saw Blades –  
Maximum Blade Cutting Depths and  
Recommended Operating Speeds

Note: Diamond blade cutting depths listed are approximate. Actual cutting depth will vary with the exact blade diameter or saw type, or the exact diameter of the blade flanges. Cutting depth will also be reduced if saw components extend below the blade flanges.

BLADE DIAMETER	CUTTING DEPTH	IDEAL SPEED (RPM)	MAXIMUM SPEED (RPM)
8"	2"	4,536	7,640
9"	2-1/2"	2,640	6,600
10"	3"	2,446	6,115
14"	4-5/8"	2,592	4,365
18"	6-5/8"	2,016	3,395

It is the user's responsibility to refer to and comply with ANSI B7.1





Norton Clipper cup grinders are available in a range of specifications and diameters providing a solution for a number of applications in the building and construction industry. There are many benefits to diamond grinding. It's very fast, low-cost and creates little noise compared to other concrete cutting options. It has become a very popular choice in the commercial construction and DIY home improvement industries.

- Applications:** Used on right angle grinders to grind concrete, stone and masonry materials.
- Size Range:** 4" – 7"
- Segment Height:** .177", .210"
- Range:**
- Abrasive Grain:** Diamond
- Mounting Options:** 5/8"-11 attachment optimized for all popular angle grinders, 7/8-5/8"-20mm
- Options:** Standard – single row or double row available  
iHD (Infiltrated High-Density) has thicker body, larger ventilation holes for better cooling
- Machines Used:**  RIGHT-ANGLE GRINDER

## General-Purpose and Masonry Building Materials

Dry – Cup Grinder  

**3X3 WITH iHD TECHNOLOGY**   
The 3X3 cup grinder ensures very high material removal rate, extreme comfort while working without vibrations and a self-sharpening feature. These new iHD cups offer the best finishing and longest life even on softer, more abrasive materials.

SIZE (D x H)	SEGMENT HEIGHT	MAX RPM	PART #	UPC #
4 x 5/8"-11	.177"	15,000	3X3CG0400	701846 <b>01763</b>
5 x 5/8"-11	.177"	12,225	3X3CG0500	701846 <b>01766</b>
7 x 5/8"-11	.177"	8,730	3X3CG0700	701846 <b>01769</b>

**CHARGER WITH iHD TECHNOLOGY**   
The Charger cup grinder ensures a high material removal rate and more comfortable work. These new iHD cups provide a better finish and long life on a wide range of materials.

SIZE (D x H)	SEGMENT HEIGHT	MAX RPM	PART #	UPC #
4 x 5/8"-11	.177"	15,000	CGCG0400	701846 <b>01762</b>
5 x 5/8"-11	.177"	12,225	CGCG0500	701846 <b>01765</b>
7 x 5/8"-11	.177"	8,730	CGCG0700	701846 <b>01768</b>

**CLASSIC WITH iHD TECHNOLOGY**   
The Classic cup grinder provides efficient material removal rate thanks to the small contact surfaces of the segments. The cups also have flat sides to avoid damaging walls or ceilings during flush grinding.

SIZE (D x H)	SEGMENT HEIGHT	MAX RPM	PART #	UPC #
4 x 5/8"-11	.177"	15,000	CCCG0400	701846 <b>01761</b>
5 x 5/8"-11	.177"	12,225	CCCG0500	701846 <b>01764</b>
7 x 5/8"-11	.177"	8,730	CCCG0700	701846 <b>01767</b>

**CLASSIC**   
Available in a range of sizes and segment designs for optimum performance by life or by speed. Ideal for leveling all types of masonry materials, brick, block, concrete and stone. Strategically placed hole designs help ventilate dust from the surface to extend the life of the cups.

SIZE (D x H)	SEGMENT HEIGHT	MAX RPM	PART #	UPC #
<b>Single Row for Fast Stock Removal</b>				
4 x 7/8-5/8-20mm	.210"	15,000	CHSCPH0400	701846 <b>82585</b>
5 x 7/8-5/8-20mm	.210"	12,225	CHSCPH0500	701846 <b>84035</b>
7 x 7/8-5/8-20mm	.210"	8,730	CHSCPH0700	701846 <b>82594</b>
4 x 5/8"-11	.210"	15,000	CHSCPT0400	701846 <b>82555</b>
5 x 5/8"-11	.210"	12,225	CHSCPT0500	701846 <b>84036</b>
7 x 5/8"-11	.210"	8,730	CHSCPT0700	701846 <b>82593</b>
<b>Double Row for Long Life, Smooth Finish</b>				
4 x 7/8-5/8-20mm	.210"	15,000	CHDCPH0400	701846 <b>82588</b>
5 x 7/8-5/8-20mm	.210"	12,225	CHDCPH0500	701846 <b>84037</b>
7 x 7/8-5/8-20mm	.210"	8,730	CHDCPH0700	701846 <b>82596</b>
4 x 5/8"-11	.210"	15,000	CHDCPT0400	701846 <b>82586</b>
5 x 5/8"-11	.210"	12,225	CHDCPT0500	701846 <b>84038</b>
7 x 5/8"-11	.210"	8,730	CHDCPT0700	701846 <b>82595</b>

## Accessories

**VACUUM SHROUD KIT**  
The Vacuum Shroud's design creates a cyclonic affect extracting dust and debris from the work surface into the support vacuum. This prolongs the life of the grinding cup and grinder and provides a smoother surface while decreasing the chance of dust particle inhalation.

DESCRIPTION	UPC #
Kit includes: one shroud, five different adapter rings to fit most popular right-angle grinders, and one 7" Norton Clipper Classic single row cup wheel	701846 <b>41039</b>





Core bits are cutting tools used to remove a cylindrically shaped piece of material. A core drill is designed to cut a hole and remove a core sample or to drill a hole without leaving material behind. Diamond core bits have diamond cutting tips and are frequently used for drilling in materials such as concrete, stone, and asphalt.

- Applications:** Used on core drills in materials such as concrete, stone and other hard materials
- Size Range:** 2" – 10"
- Segment Height Range:** .254", .393"
- Abrasive Grain:** Diamond
- Mounting Options:** 1-1/4"-7 threads
- Machines Used:**



## Reinforced Concrete and Harder Building Materials

WET – Hard Aggregates



**PARADIGM** Premium diamond in the turbo segment permits the core to penetrate quickly and efficiently into the toughest cured concrete, for significantly increased performance. The 14" tube length with 1-1/4"-7 threads fits a wide range of core drill mounting arbors.

SIZE IN INCHES	SIZE IN MM	SEGMENT HEIGHT	MAX RPM	PART #	UPC #
2"	51mm	.490"	2,000	PDBIT0200	701846 <b>01410</b>
2-1/2"	64mm	.490"	1,300	PDBIT0250	701846 <b>01411</b>
3"	76mm	.490"	1,300	PDBIT 0300	701846 <b>01412</b>
3-1/2"	89mm	.490"	1,300	PDBIT0350	701846 <b>01413</b>
4"	102mm	.490"	1,000	PDBIT0400	701846 <b>01414</b>
4-1/2"	114mm	.490"	800	PDBIT0450	701846 <b>01415</b>
5"	127mm	.490"	800	PDBIT0500	701846 <b>01416</b>
6"	152mm	.490"	665	PDBIT0600	701846 <b>01417</b>
7"	178mm	.490"	600	PDBIT0700	701846 <b>01418</b>
8"	203mm	.490"	500	PDBIT0800	701846 <b>01419</b>
10"	254mm	.490"	400	PDBIT1000	701846 <b>01706</b>



**CLASSIC** Economical choice for use in harder concrete with heavy reinforcement and masonry materials with good performance.

SIZE IN INCHES	SIZE IN MM	SEGMENT HEIGHT	MAX RPM	PART #	UPC #
2"	51mm	.350"	2,000	CHBIT0200	701846 <b>82762</b>
3"	76mm	.350"	1,300	CHBIT0300	701846 <b>82765</b>
4"	102mm	.350"	1,000	CHBIT0400	701846 <b>82767</b>
6"	152mm	.350"	665	CHBIT0600	701846 <b>82771</b>
8"	203mm	.350"	500	CHBIT0800	701846 <b>82773</b>
10"	254mm	.350"	400	CHBIT1000	701846 <b>82774</b>

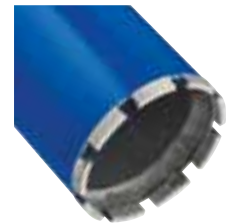

### TECH TIP

Core Bits – Minimum and Maximum Recommended Operating Speeds

BIT DIAMETER	MINIMUM RPM	IDEAL SPEED (RPM)	MAXIMUM RPM
1"	2,400	3,200	4,000
2"	1,200	1,600	2,000
3"	800	1,050	1,300
4"	600	800	1,000
5"	475	640	800
6"	400	530	665
7"	340	450	600
8"	300	400	500
10"	240	320	400

Note: For half inch increments, go to the next larger bit diameter.



It is the user's responsibility to refer to and comply with ANSI B7.1



### High-Speed Gas Saws

No more pre-mixing oil and fuel – the patented iLube option automatically controls mixing for maximum efficiency, and the saw drops to idle speed when the oil is low – eliminating possible machine damage

### Walk-Behind Saws

Proven, robust and functional for ideal user comfort. The professionals' choice for outstanding walk behind cutting performance, wet or dry.

### Masonry Saws

Norton introduced the first masonry saw over 70 years ago and they have become the industry standard for masons worldwide.

For the full line of quality Norton Clipper equipment, please contact your local Norton sales representative

## High-Speed Gas Saws

### CP500 SERIES HIGH-SPEED SAWS

The Norton Clipper CP500 high-speed cut-off saw might be new to the market, but it's destined to be an asset on any crew. It's fully designed with the user in mind to not only cut a smooth, fast track, but it's also fully equipped to handle the everyday performance of any jobsite with unremitting durability and reliability. Select a standard model or upgrade to the world's first patented automatic lubrication system, Norton Clipper iLube.

The patented iLube option automatically controls mixing of oil and fuel for maximum efficiency. An electronic sensor will indicate a low oil level and adjust the engine to idle to prevent engine damage.

DESCRIPTION	SHAFT RPM	PART #	UPC #
12" Standard High-Speed Cut-Off Saw	4,500	CP512-300	701846 <b>47559</b>
12" iLube High-Speed Cut-Off Saw	4,500	CP512-300i iLube	701846 <b>47561</b>
14" Standard High-Speed Cut-Off Saw	4,500	CP514-350	701846 <b>47563</b>
14" iLube High-Speed Cut-Off Saw	4,500	CP514-350i iLube	701846 <b>47565</b>

### ACCESSORIES

High-Speed Saw Wheel Kit	005101 <b>09845</b>
High-Speed Saw Tool Kit	005101 <b>09846</b>



## Walk-Behind Push Saws



### GC55 EARLY ENTRY/GREEN SAW

With a compact, light-weight design backed by the reliable Honda 5HP gasoline engine, the GC55 early entry saw is intended for a variety of applications. From green, cured or decorative concrete cutting to expansion joints, the features of this small push saw are hard to beat in a single saw. The low, wide profile of the frame, along with the front mount blade, contribute to producing a more disciplined cut.

UPC #	MOTOR	WEIGHT	GUARD
701846 <b>30005</b>	Honda GX160	115 lbs	10"



### C1318P GASOLINE SAW

The next generation of 13HP saws. The C1318P features shock-absorbing handle bars. The new sleek design of the water tank, with increased capacity and improved securing, adds an additional 1.5 gallons of water over the cut. And, a newly-designed belt tensioning system helps keep the saw cutting true and true. All these features, coupled with the Honda 13HP engine, make the C1318P the premiere choice for rental and service work.

UPC #	MOTOR	WEIGHT	GUARD
701846 <b>42453</b>	Honda GX390	220 lbs	18"



### C13PE GASOLINE SAW

Rental equipment has to withstand any and all conditions by user and application. For that reason, the Norton Clipper C13PE or CP14PE suits any rental fleet that both the novice and expert will appreciate to hold-up through tough situations. The 18" blade guard, ride-on water system and quick-release blade guard lock all keep safety in mind while the rugged frame, powerful engine and easy-to-use console makes cutting a breeze.

UPC #	MOTOR	WEIGHT	GUARD
701846 <b>47524</b>	Honda GX390	220 lbs	18"

## Large Masonry Saws

### BBL BLOCKBUSTER LARGE MASONRY SAWS

Having introduced the first masonry saw over 70 years ago, the Norton Clipper BBL heavy-duty block saws have become the industry standard for masons worldwide. These models are equipped with single-phase electric motors and come with a blade capacity of 14" or 20". Extended water pan and open back frame allow cutting of larger materials. The balanced cutting head makes for effortless cutting depth positioning. Having a rugged all-steel frame design with forklift brackets allows these saws to resist twisting and damage during transport around a job site. For other sizes and horsepower machines, or for gasoline-powered versions, contact your Norton sales representative.

DESCRIPTION	HP	PART #	UPC #
BBL547 Blockbuster Saw with Baldor electric motor; 14" blade guard capacity	5	BBL547	701846 <b>83211</b>
BBL527 Blockbuster Saw with Baldor electric motor; 20" blade guard capacity	5	BBL527	701846 <b>83150</b>

#### ACCESSORIES

Electric Water Pump – PE-1	701846 <b>68392</b>
Conveyor Cart Replacement for BBL	003100 <b>07390</b>



Electric Water Pump



Conveyor Cart Replacement



## Compact Masonry Saws

### BBC BLOCKBUSTER COMPACT MASONRY SAWS

Combines the performance of a full size masonry saw with the convenience of portability. Also available in gas or electric versions, the BBC saws have a rugged jig-welded frame, durable enough for even the heaviest work load. Standard rear wheel dolly design and removable legs make transport and set-up easy. For other sizes and horsepower machines, or for gasoline-powered versions, contact your Norton sales representative..

DESCRIPTION	HP	PART #	UPC #
BBC157 Blockbuster Saw with Baldor electric motor; 14" blade guard capacity	1.5	BBC157	701846 <b>82488</b>
BBC207 Blockbuster Saw with Baldor electric motor; 14" blade guard capacity	2	BBC207	701846 <b>82501</b>
BBC207 Blockbuster Saw with Baldor electric motor; 20" blade guard capacity	3	BBC307	701846 <b>30011</b>
BBC547 Blockbuster Saw with Honda gasoline motor; 14" blade guard capacity	5.5	BBC547	701846 <b>82175</b>
BBC507 Blockbuster Saw with Honda gasoline motor; 20" blade guard capacity	5.5	BBC507	701846 <b>30012</b>

#### ACCESSORIES

Electric Water Pump – PE-1	701846 <b>68392</b>
Conveyor Cart Replacement for BBC	003100 <b>07367</b>



## Mini Masonry Saws

### BBM BLOCKBUSTER MINI MASONRY SAWS

The innovative design of these small masonry saws has been copied many times due to its compact, all-steel unibody construction, giving the best weight-to-strength distribution. A 14" blade capacity and ergonomically-designed, three-position locking, cutting head provides a safe, clear view of the work area. Whether your choice is the 3HP brush motor or the 1.5HP induction motor for heavier commercial use, both come with features such as overload protection, garden hose connection and a channeled-flow water pan to direct dust and slurry away from the operator.

DESCRIPTION	HP	PART #	UPC #
Blockbuster Mini Masonry Saw with AC universal motor; gear drive	3	BBM307	701846 <b>00684</b>
Blockbuster Mini Masonry Saw with Induction motor; belt drive	2	BBM158	701846 <b>26327</b>

#### ACCESSORIES

Vacuum Adaptor Kit (includes: back splash, adaptor and hardware)	701846 <b>00753</b>
Wet Kit	701846 <b>00704</b>
Stand	701846 <b>00691</b>



Wet Kit



Stand



All saws on this page come equipped with genuine Norton Clipper diamond blades.

get wired  
**FOR SUCCESS**

Our broad wire brush offering includes the shapes, wire configurations and filament materials you'll need for heavy- to light-duty brushing applications.





Our Norton wire brush broad offering includes all the basic shapes and configurations. Informative, attractive packaging clearly explains dimensions, structure, safety and machine usage. All brushes are individually clamshell packaged unless otherwise noted. When using wire brushes, be sure to comply with ANSI B165 "Power-Driven Brushing Tools: Safety Requirement for the Design, Care and Use." and safety documents on [www.nortonabrasives.com](http://www.nortonabrasives.com) website.

**Applications:**

Cleaning rust, scale and dirt; light deburring; edge blending; roughening for adhesion; finishing for appearance; finish preparation prior to plating or painting

**Shapes:**

Cup, saucer cup, wheel, joint/crack, end brush, hand brush

**Wire Design:**

Twist knot, crimped, and stringer bead

**Other:**

Color-coded for easy identification:



**Machine Used:**

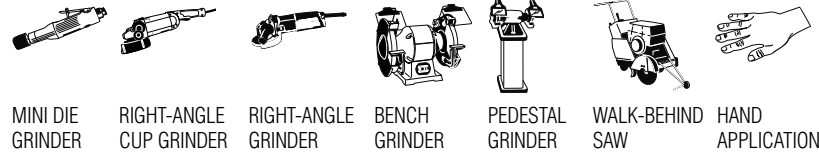

**Why Use Wire Brushes vs. Other Brushes, Coated Abrasive, and Surface-Cleaning Products**

Norton Wire brushes remove rust and oxidations, paint, slag, weld spatter and other unwanted surface contaminants, without removing any base material. Other products can remove base material along with the surface contaminant. Our flexible wire brushes are able to clean hard-to-reach places and conform to irregular surfaces, which more rigid products cannot do.

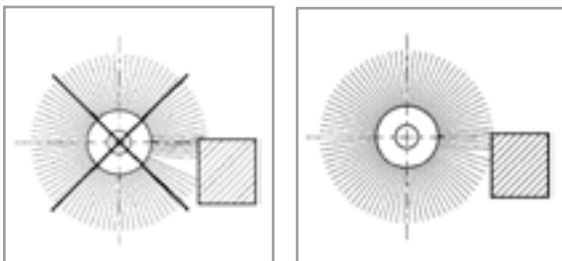

Let the tip of the wire brush do the work – operate the brush with the lightest pressure. If heavy pressure is used, wires will be overstressed, resulting in a wiping action, which, if continued, creates wire fatigue and will shorten brush life. Reversing the rotation periodically sharpens the wire tips for faster cutting action and longer life. Use finest suitable wire size.



Crimped      Standard Twist Knot      Stringer Bead Twist Knot

Workpiece Material To Wire Brush Recommendation Guide

Workpiece Material	Carbon Steel	Stainless Steel	Brass	Nylon
ALUMINUM		■	■	■
BRASS		■	■	■
COPPER		■	■	■
IRON	■		■	■
PLASTIC			■	■
CARBON STEEL/METAL	■		■	■
STAINLESS STEEL		■	■	■
WOOD	■	■	■	■

**TECH TIP**

**When to Use Crimped Wire vs. Standard Twist Knot vs. Stringer Bead Twist Knot Brushes**

**Crimped Wire Brushes**

Crimped wire brushes' individual filaments are supported only by each other – creating extra flexibility.

Ideal for work on irregular surfaces, finer surface finishing, and light- to medium-duty contaminant removal applications.

**Standard Twist Knot Wire Brushes**

Ensuring longer life, making them the choice for more aggressive applications requiring higher-impact action, and a rougher surface finish.

Standard twist knot brushes are made with straight wire filaments that are twisted together to make more rigid rope- or cable-like pieces.

**Stringer Bead Twist Knot Wire Brushes**

Stringer bead twist knots (vs. standard twist knots) are more tightly twisted to the end of the knot, creating a narrower face and highest-impact action.

The choice for tough weld scale cleaning, removing the bead scale that occurs at the initial joining of two sections of pipe, root and hot weld pass cleaning, and the most aggressive brushing applications.

## Wire Diameter

Choose the appropriate wire brush wire diameter for the job

- Very fine to fine wire for light-duty applications
- Medium to coarse wire for heavy-duty applications

Wire	Coarse		Medium to Coarse		Medium		Fine		Very Fine	
DIAMETER IN INCHES	.032	.020	.020	.015	.012	.0104	.010	.008	.006	.005
DIAMETER IN MM	.80	.50	.50	.37	.30	.26	.25	.20	.15	.13

### TECH TIP

#### Trim Length

Choose the appropriate trim length for the job. "Trim Length" equals the amount of usable filament:

- Longer trim lengths are more flexible, making them the choice for irregular surfaces
- Shorter trim lengths are fast acting and more rigid, so better for more severe applications

### TECH TIP

#### Filament Do's and Don'ts

Excessive pressure bends and could break brush filaments. Instead of increasing the pressure applied, consider:

- A more aggressive brush:
  - Increasing wire diameter
  - Shorter trim length
- Different brush type, e.g. twist knot versus crimped wire
- Increasing RPM without exceeding the MAX RPMs marked on the brush



To learn which wire style is the best choice for your job and see what makes Norton Wire Brushes the ultimate power tool accessories visit <https://nortonsga.us/wgazw>



Better choice for deburring, removing rust, paint, corrosion and weld spatter from metal surfaces

## BLUEFIRE WIRE BRUSHES

- Perfect for removing rust, scale, paint, and dirt from metal and other surface
- Available in a variety of brush types and sizes for large flat areas to small, tight spaces
- Durable design provides a uniform finish while offering the longest life



Good choice for removing rust oxidation, paint, slag and weld spatter without removing base material

## GEMINI WIRE BRUSHES

- Ideal low-impact solution for refining surfaces without removing any base material
- Flexible design for cleaning hard-to-reach places and conforming to irregular surfaces, which more rigid products cannot do
- Economically priced yet solid-performing to complement your projects perfectly while bringing real savings to the bottom line



EXPANDED OFFERING

Deburring; roughing; cleaning rust, scale, paint and oxidation; cleaning corners, recesses, and other hard-to-reach areas and removing concrete and large surfaces

## WIRE CUP BRUSHES

- Used on right angle cup grinders
- Twist Knot style for heavy-duty applications
- Crimped cup for light- to medium-duty applications



### Twist Knot Wire Saucer Cup Brushes



TIER:	BETTER	BETTER
TRADENAME:	BLUEFIRE	BLUEFIRE
WIRE TYPE:	CARBON	STAINLESS

SIZE	TRIM LENGTH	MAX. RPM	STD. PKG.	PART #	PART #
<b>Twist Knot Wire Saucer Cup Brushes - Single Row - With Arbor Hole</b>					
4" x 0.020" x 5/8"-11	7/8"	15,000	5	662528 <b>33483</b>	
5" x 0.020" x 5/8"-11	1-1/8"	12,500	10	662528 <b>35585</b>	662528 <b>35586</b>

### Twist Knot Wire Cup Brushes

- Their more rigid structure allows efficient, high-impact cutting and cleaning on more demanding applications.
- Single row construction limits flaring of the brush on corners and angles



TIER:	BETTER	BETTER	BETTER	BETTER	GOOD	GOOD
TRADENAME:	BLUEFIRE	BLUEFIRE	BLUEFIRE	BLUEFIRE	GEMINI	GEMINI
WIRE TYPE:	CARBON	STAINLESS	CARBON	CARBON	CARBON	STAINLESS

SIZE	TRIM LENGTH	MAX. RPM	STD. PKG.	PART #	PART #	PART #	PART #	PART #	PART #
<b>Twist Knot Wire Cup Brushes - Single Row - With Arbor Hole</b>									
2-3/4" x 0.014" x 5/8"-11	3/4"	14,000	1	699573 <b>70106</b>	699573 <b>70107</b>				
2-3/4" x 0.014" x 5/8"-11	7/8"	14,000	5			662528 <b>38870</b>	662528 <b>38871</b>		
2-3/4" x 0.014" x 5/8"-11	1"	14,000	5			662528 <b>39109</b>			
2-3/4" x 0.020" x 5/8"-11	3/4"	14,000	5	699366 <b>53336</b>	699366 <b>53340</b>				
2-3/4" x 0.020" x 5/8"-11	7/8"	14,000	5			662528 <b>38872</b>			
2-3/4" x 0.020" x 5/8"-11	1"	14,000	10			662528 <b>39033</b>	662528 <b>38812</b>		
2-3/4" x 0.020" x 1/2"-13	3/4"	14,000	1	699573 <b>70108</b>					
2-3/4" x 0.020" x 1/2"-24	3/4"	14,000	1	699573 <b>70109</b>					
2-3/4" x 0.020" x M10 x 1.25	3/4"	15,000	5	699366 <b>53338</b>					
3" x 0.020" x 5/8"-11	7/8"	14,000	5			662528 <b>38835</b>	662528 <b>39127</b>		
3" x 0.020" x M10	7/8"	14,000	5			662528 <b>39075</b>			
3-1/2" x 0.020" x 5/8"-11	7/8"	13,000	5			662528 <b>38813</b>			
3-1/2" x 0.020" x 5/8"-11	1-3/8"	13,000	5			662528 <b>38868</b>			
3-1/2" x 0.023" x 5/8"-11	7/8"	13,000	1	699573 <b>70110</b>					
4" x 0.014" x 5/8"-11	1-1/16"	9,000	1	699573 <b>70111</b>					
4" x 0.014" x 5/8"-11	1-1/4"	9,000	5			662528 <b>39060</b>			
4" x 0.020" x 5/8"-11	1-1/8"	9,000	10			662528 <b>39103</b>			
4" x 0.020" x 5/8"-11 with bridle	1-1/16"	9,000	5	699366 <b>53345</b>	662528 <b>33947</b>				
4" x 0.023" x 5/8"-11	1-1/4"	9,000	5			662528 <b>39090</b>			
6" x 0.014" x 5/8"-11	1-3/8"	6,600	1	699573 <b>70112</b>					
6" x 0.014" x 5/8"-11	1-3/8"	6,600	5			662528 <b>39037</b>			
6" x 0.020" x 5/8"-11	1-3/8"	6,000	5	699366 <b>05965</b>	662533 <b>71115</b>	662528 <b>39104</b>	662528 <b>39129</b>		
6" x 0.023" x 5/8"-11	1-3/8"	6,000	5			662528 <b>39091</b>			
6" x 0.035" x 5/8"-11	1-3/8"	6,000	5	699366 <b>02003</b>					
<b>Twist Knot Wire Cup Brushes - Single Row - With Arbor Hole and Protective Guard</b>									
2-3/4" x 0.020" x 5/8"-11	3/4"	15,000	5			662528 <b>33492</b>			
4" x 0.020" x 5/8"-11	1-1/8"	9,000	5			662528 <b>33496</b>			
5" x 0.020" x 5/8"-11	1-1/8"	6,500	5			662528 <b>33497</b>			
<b>Twist Knot Wire Cup Brushes - Double Row - With Arbor Hole</b>									
6" x 0.020" x 5/8"-11	1-3/8"	6,000	5			699366 <b>53346</b>			



### Crimped Wire Cup Brushes

For light- to medium-duty brushing applications on flat or irregular surfaces, and bevel buffing where added flexibility is needed; fast-cutting and flexible, with heavy wire fill

- Machine for cups with arbor holes: right angle cup grinder
- Machine for shank mounted cups: straight in-line grinder, pencil grinder



TIER: **BETTER**  
TRADENAME: **BLUEFIRE**  
WIRE TYPE: **CARBON**

SIZE	TRIM LENGTH	MAX. RPM	STD. PKG.	PART #
<b>High Performance Cable Crimped Wire Cup Brushes - With Arbor Hole and Protective Guard</b>				
3" x (12 x 0.009") x 5/8"-11	7/8"	15,000	5	662528 <b>33493</b>
4" x (12 x 0.009") x 5/8"-11	1-3/16"	9,000	5	662528 <b>33494</b>



TIER: **BETTER**    **BETTER**    **GOOD**  
TRADENAME: **BLUEFIRE**    **BLUEFIRE**    **GEMINI**  
WIRE TYPE: **CARBON**    **STAINLESS**    **CARBON**

SIZE	TRIM LENGTH	MAX. RPM	STD. PKG.	PART #	PART #	PART #
<b>Crimped Wire Cup Brushes – With Arbor Hole</b>						
2-3/4" x 0.014" x 5/8"-11	1"	14,000	5			662528 <b>38856</b>
2-3/4" x 0.020" x 3/8"-24	1"	14,000	5			662528 <b>39080</b>
3" x 0.014" x 5/8"-11	13/16"	14,000	5			662528 <b>39076</b>
3" x 0.014" x 5/8"-11	7/8"	14,000	5	699366 <b>53341</b>	662528 <b>36362</b>	
3" x 0.014" x 5/8"-11	1"	14,000	10			662528 <b>39034</b>
4" x 0.014" x 5/8"-11	1-3/16"	9,000	5	699366 <b>53347</b>		
4" x 0.014" x 5/8"-11	1-1/8"	9,000	10			662528 <b>39121</b>
4" x 0.020" x 5/8"-11	1-3/16"	9,000	5		662528 <b>43844</b>	
5" x 0.014" x 5/8"-11	1-3/8"	8,000	5			662528 <b>39105</b>
6" x 0.014" x 5/8"-11	1-1/8"	6,000	5	699366 <b>53348</b>		
6" x 0.020" x 5/8"-11	1-1/8"	6,000	5	699366 <b>53349</b>		



TIER: **GOOD**    **GOOD**    **GOOD**  
TRADENAME: **GEMINI**    **GEMINI**    **GEMINI**  
WIRE TYPE: **CARBON**    **STAINLESS**    **BRASS**

SIZE	TRIM LENGTH	MAX. RPM	STD. PKG.	PART #	PART #	PART #
<b>Crimped Wire Cup Brushes - Shank Mounted</b>						
5/8" x 0.005" x 1/8"	1/4"	37,000	100			662528 <b>39087</b>
1-3/4" x 0.006" x 1/4"	1/2"	13,000	10	662528 <b>38857</b>		
1-3/4" x 0.012" x 1/4"	1/2"	13,000	10	662528 <b>38858</b>		
1-3/4" x 0.012" x 1/4"	3/4"	13,000	12	662528 <b>39028</b>		
2" x 0.010" x 1/4"	5/8"	10,500	12		662528 <b>38859</b>	
2" x 0.012" x 1/4"	5/8"	13,000	12	662528 <b>39110</b>		
2-1/4" x 0.014" x 1/4"	5/8"	4,500	10	662528 <b>38860</b>		

Applications range from the toughest, more aggressive surface cleaning applications, including removing weld scale, spatter, extra-heavy rust and corrosion, cleaning pipe joints, or surface roughening to light- to medium- duty surface cleaning and contaminant removal



EXPANDED OFFERING

## WIRE WHEEL BRUSHES

- Available in Standard Twist Knot, Stringer Bead Twist Knot, and Crimped
- See specific machines for each wire wheel below

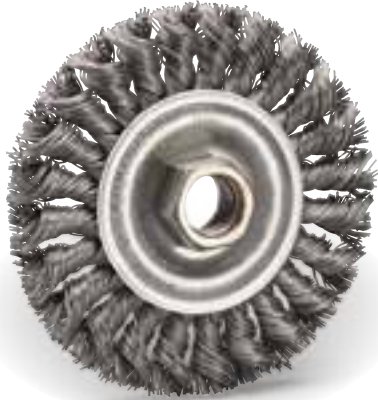

### Standard Twist Knot Wire Wheel Brushes

Our twist knot wire design provides added rigidity for extra cutting and cleaning power, and a rougher surface finish.

- Wheel brushes with arbor holes perform well on more aggressive applications requiring high-impact action: tough welding and metal fabrication applications, including removing weld scale, spatter, extra-heavy rust.
- These shank-mounted wheel brushes are used for small-to-medium-duty jobs requiring some flexibility and lighter brushing action for corrosion, or surface roughing applications. These brushes are used on straight shaft, die, pencil grinders, drills and right angle grinders.



TIER:	BETTER	BETTER	BETTER	GOOD	GOOD
TRADENAME:	BLUEFIRE	BLUEFIRE	BLUEFIRE	GEMINI	GEMINI
WIRE TYPE:	CARBON	STAINLESS	PIPELINE	CARBON	STAINLESS

SIZE	FACE WIDTH	TRIM LENGTH	MAX. RPM	STD. PKG.	PART #	PART #	PART #	PART #	PART #
<b>Standard Twist Knot Wire Wheel Brushes – With Arbor Hole</b>									
3" x 0.15" x 1/2"-3/8"	3/8"	5/8"	20,000	6	699366 <b>53314</b>				
3" x 0.014" x 3/8"	3/8"	5/8"	25,000	1				662528 <b>39021</b>	
4" x 0.014" x 5/8"-11	5-16"	7/8"	20,000	5				662528 <b>39011</b>	
4" x 0.014" x 5/8"-11	1/2"	7/8"	20,000	10				662528 <b>39052</b>	
4" x 0.020" x 5/8"-11	1/4"	3/4"	20,000	10					662528 <b>39132</b>
4" x 0.020" x 5/8"-11	1/2"	3/4"	20,000	5	662528 <b>38300</b>				
4" x 0.020" x 5/8"-11	1/2"	7/8"	20,000	10				662528 <b>39035</b>	662528 <b>39020</b>
4" x 0.020" x 5/8"-11	1/2"	7/8"	20,000	5				662528 <b>39078</b>	
4" x 0.020" x 5/8"-11	9/16"	7/8"	20,000	10				662528 <b>39019</b>	
4-1/2" x 0.020" x 5/8"-11	1/2"	1"	20,000	5	699366 <b>06275</b>				
4-1/2" x 0.020" x 5/8"-11 (black hub)	1/2"	1"	20,000	6			662528 <b>40466</b>		
4-1/2" x 0.020" x 5/8"-11	1/2"	1"	20,000	6	699366 <b>53331</b>				
4-1/2" x 0.020" x 5/8"-11	1/2"	1"	20,000	5		699366 <b>53333</b>			
5" x 0.020" x 5/8"-11	1/2"	1"	12,500	5	662528 <b>33487</b>	662528 <b>33488</b>			
6" x 0.014" x 5/8"-11	1/2"	1-1/2"	12,000	5				662528 <b>39014</b>	
6" x 0.020" x 5/8"-11	1/2"	1-3/8"	12,000	5	699366 <b>53352</b>	662533 <b>71540</b>			
6" x 0.020" x 5/8"-11	5/8"	1-1/4"	12,000	5				662528 <b>39107</b>	662528 <b>39594</b>
6" x 0.020" x 5/8"-11	1/2"	1-3/8"	12,000	5	699366 <b>53327</b>				
6" x 0.025" x 5/8"-11	5/8"	1-1/4"	9,000	5				662528 <b>39593</b>	



TIER:	GOOD
TRADENAME:	GEMINI
WIRE TYPE:	CARBON

SIZE	FACE WIDTH	TRIM LENGTH	MAX. RPM	STD. PKG.	PART #
<b>Standard Twist Knot Wire Wheel Brushes - Shank Mounted</b>					
3" x 0.014" x 1/4"	1/4"	5/8"	25,000	12	662528 <b>39015</b>
3-1/4" x 0.014" x 1/4"	3/8"	5/8"	25,000	10	662528 <b>39031</b>
4" x 0.014" x 1/4"	1/2"	7/8"	25,000	8	662528 <b>39032</b>



### Stringer Bead Twist Knot Wire Wheel Brushes

The choice for toughest weld scale cleaning; removing the bead scale that occurs at the initial joining of two sections of pipe; root, and hot weld pass cleaning, and the most aggressive brushing applications. Stringer Bead Twist Knot Wire Wheel Brushes are best used on right angle grinders for difficult jobs.



TIER:	BETTER	BETTER	BETTER	BETTER	BETTER	GOOD	GOOD
TRADENAME:	BLUEFIRE	BLUEFIRE	BLUEFIRE	BLUEFIRE	BLUEFIRE	GEMINI	GEMINI
WIRE TYPE:	CARBON	CARBON	CARBON	STAINLESS	STAINLESS	CARBON	STAINLESS
OTHER:		Pipeline	Heavy-Duty		Pipeline		

SIZE	FACE WIDTH	TRIM LENGTH	MAX. RPM	STD. PKG.	PART #	PART #	PART #	PART #	PART #	PART #
<b>Stringer Bead Knot Wire Wheel Brushes – With Arbor Hole</b>										
3" x 0.020" x 1/4"	3/8"	1"	20,000	10						662528 <b>39096</b>
4" x 0.020" x 5/8"-11	3/16"	7/8"	20,000	5	699366 <b>06277</b>			699366 <b>06278</b>		
4" x 0.020" x 5/8"-11	3/16"	7/8"	20,000	6	662528 <b>33489</b> *	662528 <b>40467</b> *			662528 <b>42233</b> *	
4" x 0.020" x 5/8"-11	3/16"	7/8"	20,000	10	662533 <b>70022</b> *					662528 <b>39036</b> 662528 <b>39039</b>
4" x 0.020" x 5/8"-11	1/4"	7/8"	20,000	5						662528 <b>38997</b>
4" x 0.020" x 5/8"-11	1/4"	7/8"	20,000	10						662528 <b>38989</b>
4" x 0.020" x 5/8"-11	1/2"	7/8"	20,000	10						662528 <b>39130</b>
4" x 0.020" x 5/8"-11	1/2"	1"	20,000	10						662528 <b>39106</b>
4" x 0.020" x M10	3/16"	7/8"	20,000	6			699573 <b>70144</b>			
4" x 0.020" x M10	3/16"	7/8"	20,000	10						662528 <b>39038</b>
4-1/2" x 0.020" x 5/8"-11	3/16"	3/16"	15,000	5						662528 <b>39111</b>
4-1/2" x 0.020" x 5/8"-11	3/16"	1-1/8"	15,000	6		662528 <b>42299</b> *	662528 <b>44886</b>			
5" x 0.020" x 5/8"-11	3/16"	7/8"	12,500	10	662528 <b>33490</b> *			662528 <b>33491</b> *		
5" x 0.020" x 5/8"-11	1/2"	7/8"	12,500	5						662528 <b>39133</b>
6" x 0.020" x 5/8"-11	3/16"	1-3/8"	9,000	10	699366 <b>53350</b>	662528 <b>40469</b> *	662528 <b>44887</b>	699366 <b>53351</b>		
6-7/8" x 0.020" x 5/8"-11	3/16"	1-1/8"	9,000	5						662528 <b>39026</b>
6-7/8" x 0.020" x 5/8"-11	3/16"	1-1/8"	9,000	10	699366 <b>53329</b> *	662528 <b>40468</b> *	662528 <b>43919</b> *	662533 <b>71116</b> *		
6-7/8" x 0.020" x 5/8"-11	3/16"	1-1/8"	9,000	6	662528 <b>10992</b>					
Double Hub										
9" x 0.020" x 5/8"-11	3/16"	2-1/8"	6,000	6	662528 <b>37993</b>					
<b>Stringer Bead Knot Wire Wheel - With Arbor Hole – For Joint/Crack Cleaning with Walk-Behind Machines</b>										
12" x 0.035" x 1"-DP	3/8"	3-1/4"	4,500	2	699366 <b>06280</b>					

\*Bulk Packed Item



### Radial Wheel

Nylon Radial Wheel Brushes are best used for deburring, surface and light cleaning, adding an edge radius, on ferrous and non-ferrous parts. The long trim length is ideal when used on intricate or irregular parts.

- Machine: Bench and Pedestal, Automated CNC, Inline Grinders



TIER:	GOOD
TRADENAME:	GEMINI
WIRE TYPE:	NYLON

SIZE	FACE WIDTH	TRIM LENGTH	MAX. RPM	STD. PKG.	PART #
<b>Radial Wheel</b>					
3" x 3/8" x 5/8"	3/8"	15/16"	15,000	12	662528 <b>38842</b>



TIER:	<b>BETTER</b>	<b>GOOD</b>	<b>GOOD</b>
TRADENAME:	<b>BLUEFIRE</b>	<b>GEMINI</b>	<b>GEMINI</b>
WIRE TYPE:	<b>CARBON</b>	<b>CARBON</b>	<b>STAINLESS</b>

### Crimped Wire Wheel Brushes

Shank-mounted wheel brushes are used on straight shaft, die, and pencil grinders, and drills. Wheel brushes with arbor holes are used on bench and pedestal grinders. Their extra flexibility and lower impact makes these brushes an excellent choice for cleaning irregular surfaces and finer surface finishing, and light to medium duty surface contaminant removal applications. May be used individually or stacked on a shaft.

- Narrow-faced brushes are ideal for general-purpose brushing of uneven or difficult-to-reach surfaces.
- Medium-faced brushes clean larger surface areas and have longer life.



Crimped Wire Narrow Face - Carbon Steel - with Arbor hole



Crimped Wire - Carbon Steel - Shank Mounted

SIZE	FACE WIDTH	TRIM LENGTH	MAX. RPM	STD. PKG.	PART #	PART #	PART #
<b>Crimped Wire Wheels Brushes with Narrow Face - With Arbor Hole</b>							
1" x 0.008" x 5/16"	5/32"	3/16"	20,000	20		662528	<b>38949</b>
2" x 0.014" x 1/2"	3/8"	1/2"	20,000	12		662528	<b>39023</b>
3" x 0.005" x 1/2"	1/4"	1"	20,000	20			662528 <b>38960</b>
3" x 0.014" x 1/2"	5/8"	1"	20,000	10		662528	<b>39024</b>
4" x 0.014" x 5/8"-11	7/16"	7/8"	15,000	5		662528	<b>39001</b>
6" x 0.014" x 1/2"-2	3/4"	1-1/8"	6,500	5	699366	<b>53306</b>	
6" x 0.014" x 5/8"	3/4"	1-1/8"	6,000	5		662528	<b>39097</b>
6" x 0.014" x 5/8"	3/4"	1-7/16"	6,000	5		662528	<b>39088</b>
8" x 0.014" x 5/8"	3/4"	1-9/16"	4,000	5		662528	<b>39099</b>
8" x 0.014" x 5/8"	3/4"	2-1/16"	6,000	5		662528	<b>39089</b>
8" x 0.014" x 1-1/4"	5/8"	1-1/2"	4,000	5		662528	<b>38978</b>
<b>Crimped Wire Wheels Brushes with Medium Face - With Arbor Hole</b>							
4-1/2" x 0.014" x 5/8"-11		1"	13,000	6	662533	<b>70278</b>	
6" x 0.014" x 1/2"-2	1"	1-1/8"	6,500	5	699366	<b>53324</b>	
6" x 0.014" x 5/8"	1"	1-1/8"	6,500	5			662528 <b>39098</b>
8" x 0.014" x 1/2"-2	1-1/16"	1-5/8"	4,500	5	699366	<b>53326</b>	
8" x 0.014" x 5/8"	1"	1-9/16"	4,000	5			662528 <b>39100</b>
8" x 0.014" x 2"	1"	1-3/8"	4,500	5			662528 <b>39025</b>
10" x 0.014" x 3/4"	1-9/16"	2-1/2"	3,600	1			662528 <b>39102</b>
12" x 0.012" x 2"	2"	3-1/4"	3,600	1			662528 <b>39006</b>



TIER:	<b>GOOD</b>	<b>GOOD</b>	<b>GOOD</b>
TRADENAME:	<b>GEMINI</b>	<b>GEMINI</b>	<b>GEMINI</b>
WIRE TYPE:	<b>CARBON</b>	<b>STAINLESS</b>	<b>BRASS</b>

SIZE	FACE WIDTH	TRIM LENGTH	MAX. RPM	STD. PKG.	PART #	PART #	PART #
<b>Crimped Wire Wheels Brushes with Narrow Face - Shank-Mounted</b>							
3/4" x 0.005" x 3/16"	1/32"	3/16"	37,000	100	662528	<b>39084</b>	
1" x 0.005" x 1/8"	1/8"	5/16"	37,000	100			662528 <b>39085</b>
1-1/2" x 0.008" x 1/4"	1/4"	1/4"	25,000	20	662528	<b>38962</b>	
1-1/2" x 0.0118" x 1/4"	7/16"	3/8"	20,000	12	662528	<b>38999</b>	
1-1/2" x 0.014" x 1/4"	1/4"	1/4"	25,000	20	662528	<b>38963</b>	
2" x 0.006" x 1/4"	3/8"	1/2"	20,000	20	662528	<b>39029</b>	
2" x 0.008" x 1/4"	3/8"	7/16"	25,000	20	662528	<b>38964</b>	
2" x 0.0118" x 1/4"	3/8"	1/2"	20,000	20	662528	<b>39030</b>	
2" x 0.014" x 1/4"	3/8"	7/16"	25,000	12	662528	<b>38965</b>	
2" x 0.020" x 1/4"	3/8"	7/16"	25,000	20	662528	<b>38966</b>	
2-1/2" x 0.008" x 1/4"	7/16"	11/16"	25,000	10	662528	<b>38967</b>	
2-1/2" x 0.014" x 1/4"	7/16"	11/16"	25,000	12	662528	<b>38968</b>	
3" x 0.008" x 1/4"	1/2"	1"	20,000	10	662528	<b>39092</b>	
3" x 0.008" x 1/4"	7/16"	3/4"	25,000	10	662528	<b>38969</b>	
3" x 0.008" x 1/4"	7/16"	3/4"	25,000	12			662528 <b>38972</b>
3" x 0.0118" x 1/4"	1/2"	1"	20,000	10	662528	<b>39093</b>	
3" x 0.014" x 1/4"	3/8"	1/4"	20,000	12	662528	<b>39000</b>	
3" x 0.014" x 1/4"	7/16"	3/4"	25,000	10	662528	<b>38970</b>	
3" x 0.014" x 1/4"	7/16"	3/4"	25,000	12			662528 <b>38973</b>
3" x 0.014" x 1/4"	1/2"	1"	20,000	20			662528 <b>39048</b>
3" x 0.020" x 1/4"	7/16"	3/4"	25,000	12	662528	<b>38971</b>	
3" x 0.020" x 1/4"	1/2"	1"	20,000	12	662528	<b>39096</b>	
4" x 0.014" x 1/4"	1/2"	1"	25,000	12	662528	<b>38974</b>	

Clean and deburr recessed areas or inside diameters of tubes and pipes to proper surface finish; rubber and plastic flash removal; paint and rust removal, and mold and tool polishing



EXPANDED OFFERING

## END BRUSHES

- Used on CNC, Robotic, die grinders, and drill presses
- Twist knot wire end brushes for more aggressive cutting
- Crimped wire end brushes for lighter brushing action and contoured surfaces



### Twist Knot Wire End Brush

Their added wire rigidity makes these brushes the choice for more aggressive cutting.



SIZE	TRIM LENGTH	MAX. RPM	STD. PKG.	TIER:	TIER:	TIER:	TIER:
				BETTER	BETTER	GOOD	GOOD
				TRADENAME:	TRADENAME:	TRADENAME:	TRADENAME:
				WIRE TYPE:	WIRE TYPE:	WIRE TYPE:	WIRE TYPE:
				CARBON	STAINLESS	CARBON	STAINLESS
				PART #	PART #	PART #	PART #
<b>Twist Knot Wire End Brushes – Shank-Mounted</b>							
1/2" x 0.006" x 1/4"	1-1/8"	22,000	20			66252838876	
1/2" x 0.014" x 1/4"	1-1/8"	22,000	20			66252838877	
3/4" x 0.014" x 1/8"	7/8"	22,000	20			66252839056	
3/4" x 0.014" x 1/4"	7/8"	22,000	10	69957370164	69957370165		
3/4" x 0.014" x 1/4"	7/8"	22,000	20			66252838879	
3/4" x 0.020" x 1/4"	7/8"	22,000	10	69936653316*	69957370166		
3/4" x 0.020" x 1/4"	7/8"	22,000	20			66252839057	
3/4" x 0.020" x 1/4"	1"	22,000	20			66252839116	66252839118
3/4" x 0.020" x 1/4"	1-1/8"	22,000	20			66252838878	
1" x 0.006" x 1/4"	1-1/8"	22,000	20				66252838885
1" x 0.010" x 1/4"	1-1/8"	22,000	25				66252838886
1" x 0.014" x 1/4"	7/8"	22,000	10	69936606279*	69957370167		
1" x 0.014" x 1/4"	1"	22,000	20			66252838882	66252838887
1" x 0.020" x 1/4"	7/8"	22,000	10	69936653310*	69957370168		
1" x 0.020" x 1/4"	1"	22,000	20				66252839119
1" x 0.020" x 1/4"	1"	22,000	25			66252839117	

\* Bulk Packed Item



### Insert Circular Flared Crimped Wire End Brush

The flared end configuration facilitates interior side cleaning and will not harm the bottom of the hole.



### Encapsulated Hollow Center Crimped Wire End Brush

Their hollow centers effectively allow these brushes to clean around protrusions and also prevent the wires from meshing together. Encapsulating a portion of the wires' length shortens the free wires, increasing the wires' stiffness, thereby creating greater control of the brush.



SIZE	TRIM LENGTH	MAX. RPM	STD. PKG.	TIER:	TIER:
				BETTER	GOOD
				TRADENAME:	TRADENAME:
				WIRE TYPE:	WIRE TYPE:
				CARBON	CARBON
				PART #	PART #
<b>Insert Circular Flared Crimped End Brushes – Shank-Mounted</b>					
1-1/2" x 0.006" x 1/4"	1/4"	20,000	10	69957370161	
1-1/2" x 0.006" x 1/4"	7/8"	20,000	12		66252839108
1-1/2" x 0.020" x 1/4"	1/4"	15,000	10	69957370160	
1-1/2" x 0.020" x 1/4"	1"	15,000	12		66252838898
2" x 0.010" x 1/4"	1-1/8"	15,000	10		66252838899
2" x 0.0104" x 1/4"	1/2"	15,000	10	69957370162	
3" x 0.008" x 1/4"	7/8"	16,000	12		66252839047
3" x 0.008" x 1/4"	1"	16,000	10	69957370163	



SIZE	TRIM LENGTH	MAX. RPM	STD. PKG.	TIER:
				GOOD
				TRADENAME:
				WIRE TYPE:
				CARBON
				PART #
<b>Encapsulated Hollow Center Crimped Wire End Brush – Shank-Mounted</b>				
1/2" x 0.010" x 1/4"	1"	18,000	20	66252838907



### Crimped Wire End Brushes

Designed to generate lighter brushing action and reach into contoured surfaces.



TIER:	BETTER	BETTER	GOOD	GOOD
TRADENAME:	BLUEFIRE	BLUEFIRE	GEMINI	GEMINI
WIRE TYPE:	CARBON	STAINLESS	CARBON	STAINLESS

SIZE	TRIM LENGTH	MAX. RPM	STD. PKG.	PART #	PART #	PART #	PART #
<b>Crimped Wire End Brushes – Shank-Mounted</b>							
1/4" x 0.005" x 1/8"	7/16"	37,000	12				66252839086
1/2" x 0.005" x 1/4"	1"	25,000	20				66252838902
1/2" x 0.006" x 1/4"	3/8"	25,000	20			66252839040	
1/2" x 0.006" x 1/4"	1"	25,000	20			66252838889	66252839043
1/2" x 0.010" x 1/4"	1"	25,000	20			66252838890	66252839044
1/2" x 0.014" x 1/4"	7/8"	25,000	20			66252839042	
1/2" x 0.014" x 1/4"	1"	25,000	20				66252838888
1/2" x 0.020" x 1/4"	1"	25,000	20			66252838891	
3/4" x 0.006" x 1/4"	1"	22,000	10*		69936606145		
3/4" x 0.010" x 1/4"	3/8"	22,000	20			66252839053	
3/4" x 0.014" x 1/4"	1"	22,000	10*	69936653317			
3/4" x 0.020" x 1/4"	7/8"	22,000	20			66252839112	
3/4" x 0.020" x 1/4"	1"	22,000	20			66252838892	
1" x 0.005" x 1/4"	1"	22,000	20				66252838896
1" x 0.006" x 1/4"	1"	22,000	25			66252839045	66252838838
1" x 0.010" x 1/4"	3/8"	22,000	20			66252839054	
1" x 0.010" x 1/4"	1"	22,000	25				66252839055
1" x 0.010" x 1/4"	1"	22,000	20				66252838897
1" x 0.014" x 1/4"	3/4"	20,000	20			66252839094	
1" x 0.014" x 1/4"	1"	22,000	20			66252839046	
1" x 0.020" x 1/4"	7/8"	22,000	20			66252839095	
1" x 0.020" x 1/4"	1"	22,000	20			66262839113	66252839115
1" x 0.020" x 1/4"	1-3/16"	20,000	10*	69936653309			

\* Bulk Packed Item

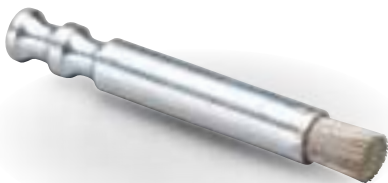

### Pencil Crimped Wire End Brush

These brushes are designed to clean counter bores, slots, blind holes, and small crevices; and light spot facing of aluminum or iron sand castings.



TIER:	GOOD
TRADENAME:	GEMINI
WIRE TYPE:	STAINLESS

SIZE	TRIM LENGTH	MAX. RPM	STD. PKG.	PART #
<b>Pencil Crimped Wire End Brush – Shank-Mounted</b>				
1/4" x 0.010" x 5/16"	3/8"	10,000	12	66252838906



### Pilot End Brush

Specially designed to clean around rivet or bolt holes; the pilot guides the brushes.



TIER:	GOOD
TRADENAME:	GEMINI
WIRE TYPE:	CARBON

SIZE	TRIM LENGTH	MAX. RPM	STD. PKG.	PART #
<b>Pilot Crimped Wire End Brush – Shank-Mounted</b>				
1/2" x 0.004" x 1/4"	3/8"	25,000	20	66252838904

Cleaning, polishing, reaming, finishing and removing debris, burrs, rust, residues, and surface contaminants inside cylindrical items, including tubes, pipes, bottles, smooth-sided and threaded holes, and other industrial components



## TUBE BRUSHES

- Use manually or fastened to portable or fixed machines (including drills, drill presses, and CNC machines)
- Available in single and double stem providing firm support when working internally
- A wide selection of shapes and filament variations to achieve the best results on many different applications

### Single Stem, Single Spiral Tube Brush – With Eye Loop

These spiral brushes have a single layer of filament twisted around a stem wire to create additional strength and higher density fill brushes. This spiral configuration ensures consistent and constant abrasive contact with the tube. Formed eye loop at the end of the stem for convenient hand use.



TIER:	<b>GOOD</b>	<b>GOOD</b>	<b>GOOD</b>	<b>GOOD</b>
TRADENAME:	<b>GEMINI</b>	<b>GEMINI</b>	<b>GEMINI</b>	<b>GEMINI</b>
WIRE TYPE:	<b>CARBON</b>	<b>STAINLESS</b>	<b>BRASS</b>	<b>NYLON</b>

SIZE	TRIM LENGTH	MAX. RPM	STD. PKG.	PART #	PART #	PART #	PART #
<b>Single Stem, Single Spiral Tube Brush – With Eye Loop</b>							
3/16" x 0.003" x 0.094"	1-1/2"	2,000	12	662528 <b>38822</b>			
3/16" x 0.004" x 0.094"	5/64"	3,000	12	662528 <b>38913</b>			
1/4" x 0.003" x 0.094"	1-1/2"	2,000	12	662528 <b>38823</b>	662528 <b>38824</b>	662528 <b>38840</b>	
1/4" x 0.004" x 0.115"	5/64"	3,000	12	662528 <b>38914</b>			
1/4" x 0.006" x 0.115"	5/64"	3,000	12	662528 <b>38915</b>			
3/8" x 0.004" x 0.125"	2"	2,000	12		662528 <b>38825</b>	662528 <b>38826</b>	
3/8" x 0.004" x 0.132"	1/8"	3,000	12	662528 <b>38916</b>			
3/8" x 0.006" x 0.168"	1/8"	3,000	12	662528 <b>38917</b>			
3/8" x 0.006" x 0.168"	1-1/2"	3,000	12		662528 <b>38946</b>		
7/16" x 0.010" x 0.125"	7/64"	3,000	12				662528 <b>38947</b>
1/2" x 0.008" x 0.221"	9/64"	3,000	12	662528 <b>38918</b>			



### Single Stem, Single Spiral Tube Brush

Similar to the single stem, single spiral tube brushes, but without eye loop. These brushes are ideal for complete internal cleaning and deburring of tubes and pipes and intricate area ensuring constant filament to surface contact.

TIER:	<b>GOOD</b>
TRADENAME:	<b>GEMINI</b>
WIRE TYPE:	<b>CARBON</b>

SIZE	TRIM LENGTH	MAX. RPM	STD. PKG.	PART #
<b>Single Stem, Single Spiral Tube Brush</b>				
7/16" x 0.005" x 0.125"	11/64"	3,000	12	662528 <b>38911*</b>
1" x 0.010" x 0.250"	2-1/2"	2,000	12	662528 <b>39074*</b>

\* No eye loop

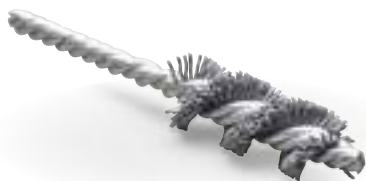

### Double Stem, Single Spiral Tube Brush – with Stem

These brushes have two stem wires. This results in a brush with high strength and one with consistent and constant abrasive contact with the tube.

TIER:	<b>GOOD</b>	<b>GOOD</b>
TRADENAME:	<b>GEMINI</b>	<b>GEMINI</b>
WIRE TYPE:	<b>BRASS</b>	<b>NYLON</b>

SIZE	TRIM LENGTH	MAX. RPM	STD. PKG.	PART #	PART #
<b>Double Stem, Single Spiral Tube Brush – With Stem</b>					
1/2" x 0.006" x 0.188"	2"	2,000	12	662528 <b>38839</b>	
3/4" x 0.040" x 0.238"	3/8"	3,000	12		662528 <b>38850</b>

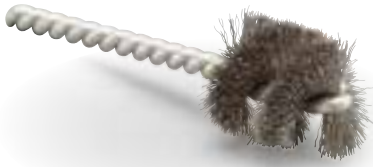

### Power Burr, Single Spiral Tube Brush – with Stem

Power burr brushes are used to remove burrs resulting from previous operations. They are designed to remove burrs without creating secondary burrs or leaving sharp edges.



TIER:	<b>GOOD</b>	<b>GOOD</b>
TRADENAME:	<b>GEMINI</b>	<b>GEMINI</b>
WIRE TYPE:	<b>CARBON</b>	<b>STAINLESS</b>

SIZE	TRIM LENGTH	MAX. RPM	STD. PKG.	PART #	PART #
<b>Power Burr Single Spiral Tube Brushes – With Stem</b>					
1/4" x 0.004" x 0.125"	1"	2,000	12	662528 <b>39061</b>	662528 <b>39081</b>
3/8" x 0.004" x 0.125"	1"	2,000	12	662528 <b>39062</b>	662528 <b>39050</b>
3/8" x 0.005" x 0.125"	9/64"	2,000	12	662528 <b>38910</b>	
1/2" x 0.005" x 0.188"	1"	2,000	12	662528 <b>39063</b>	662528 <b>39051</b>
5/8" x 0.005" x 0.188"	1"	2,000	12	662528 <b>39064</b>	
3/4" x 0.006" x 0.219"	1"	2,000	12	662528 <b>39065</b>	662528 <b>39082</b>
1" x 0.005" x 0.125"	15/32"	2,000	12	662528 <b>38912</b>	
1" x 0.005" x 0.250"	1"	2,000	12	662528 <b>39066</b>	662528 <b>39083</b>

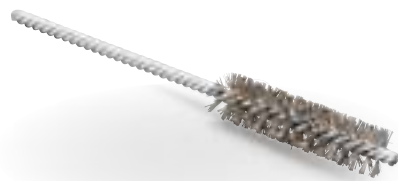

### Double Stem, Double Spiral Tube Brush – With Stem

Brush filaments are twisted between two stem wires with two layers of filament bristles. Each layer is perpendicular to the other with a single stem wire in each of the brush's four sections. This configuration ensures consistent and constant abrasive contact with the tube.



TIER:	<b>GOOD</b>	<b>GOOD</b>
TRADENAME:	<b>GEMINI</b>	<b>GEMINI</b>
WIRE TYPE:	<b>CARBON</b>	<b>STAINLESS</b>

SIZE	BRUSH LENGTH	MAX. RPM	STD. PKG.	PART #	PART #
<b>Double Stem, Double Spiral Tube Brush – With Stem</b>					
3/8" x 0.060" x 0.125"	1-1/2"	2,000	12	662528 <b>38827</b>	
1/2" x 0.004" x 0.156"	2"	2,000	12	662528 <b>38828</b>	
1/2" x 0.004" x 0.187"	5/32"	3,000	12	662528 <b>38919</b>	
1/2" x 0.006" x 0.156"	2"	2,000	12	662528 <b>39067</b>	662528 <b>38829</b>
1/2" x 0.006" x 0.187"	5/32"	3,000	12	662528 <b>38920</b>	
5/8" x 0.005" x 0.187"	2"	2,000	12	662528 <b>39068</b>	
5/8" x 0.006" x 0.208"	2"	3,000	12	662528 <b>38921</b>	
5/8" x 0.008" x 0.219"	2"	2,000	12	662528 <b>38831</b>	
5/8" x 0.010" x 0.208"	13/64"	3,000	12	662528 <b>38922</b>	662528 <b>38930</b>
3/4" x 0.004" x 0.250"	2-1/2"	2,000	12	662528 <b>39072</b>	
3/4" x 0.006" x 0.238"	1/4"	3,000	12	662528 <b>38923</b>	
3/4" x 0.006" x 0.250"	2-1/2"	2,000	12	662528 <b>39069</b>	
3/4" x 0.006" x 0.250"	2-1/2"	2,000	12	662528 <b>38832</b>	
3/4" x 0.010" x 0.238"	1/4"	3,000	12	662528 <b>38924</b>	
7/8" x 0.004" x 0.250"	2-1/2"	2,000	12	662528 <b>39073</b>	
7/8" x 0.006" x 0.238"	2"	3,000	12	662528 <b>38925</b>	
7/8" x 0.006" x 0.250"	2-1/2"	2,000	12	662528 <b>39070</b>	
1" x 0.006" x 0.238"	25/64"	3,000	12	662528 <b>38926</b>	
1" x 0.006" x 0.250"	2-1/2"	2,000	12	662528 <b>39071</b>	
1" x 0.010" x 0.238"	2"	3,000	12	662528 <b>38927</b>	
1-1/4" x 0.004" x 0.250"	2-1/2"	2,000	12	662528 <b>38833</b>	
1-1/4" x 0.010" x 0.238"	1/2"	3,000	12	662528 <b>38928</b>	
2" x 0.010" x 0.238"	7/8"	3,000	12	662528 <b>38929</b>	



### Encapsulated Double Stem, Double Spiral Tube Brush – With Stem

Encapsulating a portion of the wires' length shortens the free wires, increasing their stiffness, thereby creating greater control of the brush and a brush with the highest filament density and highest strength.



TIER:	<b>GOOD</b>
TRADENAME:	<b>GEMINI</b>
WIRE TYPE:	<b>CARBON</b>

SIZE	BRUSH LENGTH	MAX. RPM	STD. PKG.	PART #
<b>Encapsulated Double Stem, Double Spiral Tube Brush – With Stem</b>				
7/8" x 0.010" x 0.250"	2-1/4"	3,000	20	662528 <b>38948</b>





### Flue Double Spiral Tube Brushes – With 1/4" x 2" NPT Pipe Nipple with Stem

These aggressive brushes are designed specifically for efficient pipe and boiler cleaning.



TIER: **GOOD**  
TRADENAME: **GEMINI**  
WIRE TYPE: **CARBON**

SIZE	TRIM ENTH	MAX. RPM	STD. PKG.	PART #
<b>Flue Double Spiral Tube Brushes – With 1/4" x 2" NPT Pipe Nipple – With Stem</b>				
3/4" x 0.010" x 0.238"	1/4"	3,000	12	662528 <b>38931</b>
1" x 0.010" x 0.313"	25/64"	3,000	12	662528 <b>38932</b>
1-1/4" x 0.012" x 0.313"	1/2"	3,000	12	662528 <b>38933</b>
1-3/4" x 0.012" x 0.313"	1/2"	3,000	12	662528 <b>38934</b>
2-1/4" x 0.012" x 0.313"	1/2"	3,000	12	662528 <b>38935</b>
2-3/4" x 0.014" x 0.313"	1/2"	3,000	12	662528 <b>38936</b>



### Side-Action Tube (Burrite) Crimped Wire Tube Brushes – with Stem

Their dense side filament configuration creates increased bristle rigidity with minimal flexing, to aggressively clean the tube without changing its geometry or surface finish.



TIER: **GOOD**  
TRADENAME: **GEMINI**  
WIRE TYPE: **CARBON**

SIZE	TRIM ENTH	MAX. RPM	STD. PKG.	PART #
<b>Side-Action (Burrite) Crimped Wire Tube Brush – With Stem</b>				
1/4" x 0.003" x 0.094"	5/64"	3,000	12	662528 <b>38908</b>
5/16" x 0.005" x 0.094"	9/16"	2,000	10	662528 <b>38834</b>
5/8" x 0.005" x 0.125"	1/4"	3,000	12	662528 <b>38909</b>



### Internal Finishing Crimped Wire Tube Brush

This square-trimmed crimped wire brush is used to clean internal surfaces in a single operation because it can simultaneously brush both the sides and bottom of a hole.



TIER: **GOOD**  
TRADENAME: **GEMINI**  
WIRE TYPE: **CARBON**

SIZE	TRIM LENGTH	FACE WIDTH	MAX. RPM	STD. PKG.	PART #
<b>Internal Finishing Crimped Wire Tube Brushes – With Stem</b>					
1-1/4" x 0.006" x 0.250"	1/2"	3/8"	4,500	10	662528 <b>38945</b>



### Micro Abrasive Single Spiral Nylon Tube Brush – With Stem

Micro brushes are ideal for ultra-fine deburring, cleaning, polishing and finishing applications.



TIER: **GOOD**  
TRADENAME: **GEMINI**  
WIRE TYPE: **NYLON/AO 600 GRIT**

SIZE	TRIM LENGTH	MAX. RPM	STD. PKG.	PART #
<b>Micro Abrasive Single Spiral Nylon Tube Brushes – With Stem</b>				
3/16" x 0.012" x 0.093"	3/64"	3,000	12	662528 <b>38853</b>
0.190" x 0.012" x 0.087"	1"	1,500	12	662528 <b>38814</b>
0.260" x 0.012" x 0.115"	1"	1,500	12	662528 <b>38815</b>
0.325" x 0.012" x 0.115"	1"	1,500	12	662528 <b>38816</b>
0.325" x 0.012" x 0.121"	1"	3,000	12	662528 <b>38854</b>
33/64" x 0.012" x 0.175"	3/16"	3,000	12	662528 <b>38855</b>
33/64" x 0.022" x 0.175"	3/16"	3,000	12	662528 <b>38851</b>
1-1/64" x 0.022" x 0.255"	3/8"	3,000	12	662528 <b>38852</b>



TIER: **GOOD**  
TRADENAME: **GEMINI**  
WIRE TYPE: **NYLON**



### Single Spiral Nylon Hand Tube Brush – With Eye Loop

These brushes are made with larger stem wires to give them the strength and rigidity needed for manual cleaning applications.

SIZE	TRIM LENGTH	MAX. RPM	STD. PKG.	PART #
<b>Single Spiral Nylon Hand Tube Brush – With Eye Loop</b>				
1/4" x 0.005" x 0.094"	9/64"	3,000	12	662528 <b>38937</b>
1/4" x 0.005" x 0.094"	2"	2,000	12	662528 <b>38818</b>
3/8" x 0.005" x 0.094"	2"	2,000	12	662528 <b>38819</b>
3/8" x 0.005" x 0.094"	9/64"	3,000	12	662528 <b>38938</b>
1/2" x 0.008" x 0.094"	3"	3,000	12	662528 <b>38939</b>
1/2" x 0.010" x 0.125"	3"	2,000	12	662528 <b>38820</b>
3/4" x 0.012" x 0.125"	21/64"	3,000	12	662528 <b>38940</b>
3/4" x 0.012" x 0.125"	3"	2,000	12	662528 <b>38821</b>
1" x 0.010" x 0.156"	25/64"	3,000	12	662528 <b>38941</b>
1" x 0.022" x 0.156"	2-1/2"	1,500	12	662528 <b>38817</b>
1-1/4" x 0.010" x 0.156"	1/2"	3,000	12	662528 <b>38942</b>
1-1/4" x 0.010" x 0.219"	1/2"	3,000	12	662528 <b>38943</b>
2" x 0.010" x 0.219"	1/2"	3,000	12	662528 <b>38944</b>

## Hand Brushes

Hand brushes come in a variety of handle and filament shapes and styles for most hand scratching applications. They are favored by many in removing scale, surface coatings, or removing weld debris.

For steel/stainless



## HAND BRUSHES

- Long handle and shoe handle brushes are made with a high-carbon, brass-coated steel; stainless steel is made with a 304L stainless
- Plastic ergonomic handle scratch brush with curved face to access hard-to-reach places. Crimped wire for longer life. Wires are wrapped up and around the metal post so they never come out.
- Narrow brush allows access into tight areas and slots



TIER: **BETTER** **BETTER** **BETTER** **BETTER** **BETTER** **BETTER** **BETTER**  
TRADENAME: **BLUEFIRE** **BLUEFIRE** **BLUEFIRE** **BLUEFIRE** **BLUEFIRE** **BLUEFIRE** **BLUEFIRE**  
WIRE TYPE: **CARBON** **STAINLESS** **CARBON** **STAINLESS** **CARBON** **STAINLESS** **STAINLESS**

SIZE	TRIM LENGTH	MAX. RPM	STD. PKG.	PART #	PART #	PART #	PART #	PART #	PART #	PART #
<b>Hand Scratch Brushes – With Handle</b>										
3" x 19"	1-3/16"	–	12	662528 <b>33948</b>	662528 <b>33950</b>					
4" x 16"	1-3/16"	–	12			662528 <b>33949</b>	662528 <b>33951</b>			
5" x 10"	1-1/8"	–	24					662528 <b>33954</b>	662528 <b>33953</b>	
3" x 7"	1/2"	–	36							662528 <b>33952</b>





When maximum conformability is needed, tough, Norton nylon brushes' flexible nylon filaments embedded with abrasive grain provide exceptional finishing and polishing and eliminate the need for costly and inconsistent hand deburring applications.

Norton nylon brushes are precision-engineered with the highest quality abrasive grains for those markets with the strictest requirements – for easy integration into today's automated machinery, CNC machining centers, transfer lines, robotic cells, and other highly-specialized machinery, as well as hand tools.

- Applications:** Deburring, cleaning, finishing, and polishing
- Brush Configurations:** Radial wheel brushes, narrow face wheel brushes, disc brushes, end brushes, and twisted brushes
- Markets:** Aerospace/aircraft, automotive, construction/utility products, medical, metal finishing, woodworking
- Abrasive Grain:** Ceramic Alumina, Silicon Carbide

### Why Choose Nylon Abrasive Brushes?

- Abrasive grain cutting points are increased as the grain is exposed and cut equally when pressure is applied to the side or tip of the filament
- Uniform distribution of grain throughout the filaments allows cutting and finishing performance levels to remain consistent throughout the life of the brush – making Norton abrasive brushes ideal for automated applications
- Heat- and stress-resistant filaments prolong brush life and allow for superior conformability to irregular surface shapes
- The grain impregnated filaments act as a flexible file to deburr and radius edge profiles with precision, without gouging or affecting the overall geometry of a part
- The filaments bend at various angles to fit contours, creating a less prominent, more uniform surface finish in comparison to wire wheels or coated abrasive products
- Brush conformability allows usage on variety of complex part shapes without the need for ultra-precise programming and fixturing that is required with other deburring and finishing tools

Currently, all Norton Blaze ceramic alumina nylon abrasive brushes are custom-made to your exact requirements. The Norton Blaze Nylon Brushes Brochure #8571 provides technical information and product availability. Your Norton representative would be pleased to review availability, quotations, and lead-times with you.



complementing our  
**ABRASIVES PORTFOLIO**

To help you finish the job, Norton tapes, masking products and micro-fiber cloths let you one-stop shop. Our goal is to get it finished faster, easier and with less hassle of multiple vendors and invoices.





Norton masking tapes feature a special solvent-based, rubber adhesive system and strong holding properties. These tapes adhere and release cleanly while providing clean edges on a variety of flat, contoured, and irregular surfaces. Norton sheetings provides superior solvent, paint, and contaminant penetration resistance. Use them during paint preparation and anywhere you need work area protection. Tear-resistant properties allow movement without ripping.

**Products:**

Attachment Tape, Masking Tape, Masking Film, Sheeting, Masking Paper

**Machine Used:**



HAND  
APPLICATION

**Best choice for general industrial application replacing permanent fastening systems (rivets, welds and liquid adhesives)**

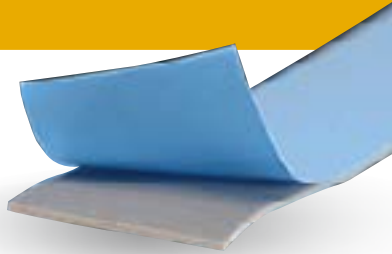

## NORTON ATTACHMENT TAPE

- Double sided, gray foam tape used in bonding performance for many interior and exterior commercial applications.
- Incredible conformability and application stretching
- Weather degradation resistance from UV and high temperatures
- Outstanding static shear adhesion
- Excellent performance in T-Block and dynamic shear
- Durable adhesion at elevated temperature
- High shock and stress absorption

DESCRIPTION	THICKNESS	1/4" x 108"	1/2" x 108"	3/4" x 108"	7/8" X 108"	1" X 108"	1-1/2" X 108"
<b>Blue Liner</b>							
Gray Double-Sided Acrylic Foam Tape	.043" (1.1mm)	636425 <b>06044</b>	636425 <b>06045</b>	636425 <b>06046</b>	636425 <b>06047</b>	662611 <b>75888</b>	662611 <b>51041</b>
Rolls/Case		40/1	20/1	10/1	10/1	10/1	6/1
DESCRIPTION	THICKNESS	1/4" X 20 YDS	1/2" X 20 YDS	7/8" X 20 YDS			
<b>Red Liner</b>							
Gray Double-Sided Acrylic Foam Tape	.043" (1.1mm)	636425 <b>05620</b>	636425 <b>05621</b>	-	636425 <b>05622</b>	-	-
Rolls/Case		12/1	12/1		12/1		
<b>Adhesion Promoter</b>							
Brush-Top Can - 220ml		636415 <b>05623</b>					
Rolls/Case		12					

### Technical Data

Performance tests are run using standard test procedures. The values presented are typical values and should not be used for specification purposes.

THICKNESS in. (mm)	90° PEEL ADHESION <sup>1</sup> (3-DAY DWELL) lb/in (N/cm)				T-BLOCK <sup>2</sup> lb/in (N/cm)	DYNAMIC SHEAR <sup>3</sup> lb/in (N/cm)	STATIC SHEAR <sup>4</sup> 7 Days /1 kg	SERVICE TEMPERATURE
	GLASS	ALUMINUM	S/S	PMMA	ALUMINUM	S/S	S/S	
.043 (1.1)	20 (35)	33 (57)	20 (34)	17 (29)	100 (29)	48 (33)	Pass and Exceeds	-35°F to 200°F (-35°C to 93°C)

<sup>1</sup> Based on ASTM D3330    <sup>2</sup> Based on ASTM D897    <sup>3</sup> Based on ASTM D1002    <sup>4</sup> Based on ASTM D3654



**Best choice for high temperature applications including high-heat curing**

## PREMIUM HIGH TEMPERATURE GREEN MASKING TAPE

- Ideal for conditions that include exposure to the high-heat curing temperatures found in automobile, truck, bus, and other transportation assembly operations, as well as aerospace manufacturing applications
- Superior strength and excellent cornering ability
- Ideal for high temperatures; can be effectively used up to 250°F (120°C) for 30 minutes without any significant loss of properties or adhesive transfer
- Can also be used up to 175°F (80°C) for one hour without leaving residues after exposure
- UV resistance for 2 days
- Can be exposed to wet sanding without adhesive transfer



**Better choice for medium-temperature applications**

## MEDIUM TEMPERATURE MASKING TAPE

- Designed for excellent performance in moderate-temperature applications
- Can be used up to 220 °F (105°C) for 30 minutes and 175°F (80°C) for one hour without any significant loss of properties; removes cleanly without leaving residues after exposure



**Good general-purpose choice**

## GENERAL PURPOSE MASKING TAPE

- Ideal for splicing, holding, packaging, and general purpose masking
- Good adhesion onto a wide variety of surfaces
- Good performance up to 175°F (80°C) for one hour without any significant loss of properties; removes cleanly without leaving residues after exposure



**It delivers very sharp, clean edges on smooth- to moderately-textured surfaces**

## BLUE CORE 14-DAY TAPE

- Our paint masking tape has a specially formulated adhesive system that provides optimum low- to medium-tack adhesion and clean removal from a variety of surfaces, for up to 14 days
- Blue Core masking tape can be used indoors or out
- The crepe paper backing is designed to enable easy unrolling and to minimize slivering



**Better choice for fine line masking needs**

## FINE LINE BLUE MASKING TAPE

- Masking color separation on plastic (TPO and RIM) automotive fascia, trim, and finished metals in high-temperature OEM bake cycles, aircraft and clean room paint operations
- Thermally-stabilized PVC backing with a rubber-based pressure sensitive adhesive
- Highly conformable, waterproof, and solvent-resistant
- Can be used from 40°F (4.4°C) to 280°F (138°C) without any significant loss of properties; removes cleanly without leaving residues after exposure



TIER:	<b>BEST</b>	<b>BETTER</b>	<b>GOOD</b>	<b>GOOD</b>	<b>BETTER</b>
	<b>PREMIUM HIGH TEMP GREEN</b>	<b>MEDIUM TEMPERATURE</b>	<b>GENERAL PURPOSE</b>	<b>BLUECORE 14 DAY TRAPE</b>	<b>FINE LINE BLUE</b>
<b>CAP CODE</b>	<b>C995</b>	<b>C988</b>	<b>C903</b>		
<b>BACKING</b>	Crepe paper	Crepe paper	Crepe paper	Fine Crepe Paper	PVC
<b>ADHESIVE</b>	Solvent-based rubber	Solvent-based rubber	Solvent-based rubber	Synthetic Rubber	Natural Rubber
<b>TENSILE STRENGTH</b>	3.0 kgf/cm, 29 N/10mm	2.6 kgf/cm, 25 N/10mm	2.5 kgf/cm, 25 N/10mm	23 lbs/in (101 N/25mm)	15 lb/in. of width, 65.6N/25mm
<b>ELONGATION AT BREAK</b>	8.50%	7.0%	7.0%	11%	150%
<b>PEEL ADHESION AT 180° ANGLE</b>	400 gf/cm, 3.9 N/10mm	370 gf/cm, 3.6 N/10mm	300 gf/cm, 2.9 N/10mm		23 oz./in. of width, 6.3N/25mm
<b>TOTAL THICKNESS</b>	120 microns (0.120mm)	110 microns (0.110mm)	100 microns (0.100mm)	5.5 mils (0.14mm)	5.4mils (.14mm)
<b>TEMPERATURE</b>	250°F (120°C) for 30 min. 175°F (80°C) for 1 hour	220°F (105°C) for 30 min. 175°F (80°C) for 1 hour	175°F (80°C) for 1 hour		40°F (4.4°C) to 280°F (138°C)

METRIC	IMPERIAL	ROLLS/CASE	PART #
<b>Premium High-Temp Green Tape</b>			
12mm x 50m	0.47 inches x 54.7 yards	72	699573 <b>10320</b>
18mm x 50m	0.71 inches x 54.7 yards	48	666233 <b>09768</b>
24mm x 50m	0.94 inches x 54.7 yards	36	666233 <b>27752</b>
36mm x 50m	1.42 inches x 54.7 yards	24	699573 <b>10323</b>
48mm x 50m	1.89 inches x 54.7 yards	20	666233 <b>09770</b>
72mm x 50m	2.83 inches x 54.7 yards	12	699573 <b>10325</b>
100mm x 50m	3.93 inches x 54.7 yards	8	699573 <b>45060</b>
200mm x 50m	7.87 inches x 54.7 yards	4	699573 <b>45063</b>
<b>Medium-Temperature Tape</b>			
12mm x 50m	0.47 inches x 54.7 yards	72	699573 <b>10326</b>
18mm x 50m	0.71 inches x 54.7 yards	48	055395 <b>44799</b>
24mm x 50m	0.94 inches x 54.7 yards	36	699573 <b>10327</b>
36mm x 50m	1.42 inches x 54.7 yards	24	662610 <b>70829</b>
48mm x 50m	1.89 inches x 54.7 yards	20	055395 <b>44800</b>
<b>General-Purpose Tape</b>			
18mm x 40m	0.71 inches x 43.7 yards	48	662611 <b>03314</b>
24mm x 40m	0.94 inches x 43.7 yards	36	662611 <b>03315</b>
36mm x 40m	1.42 inches x 43.7 yards	24	699573 <b>45064</b>
48mm x 40m	1.89 inches x 43.7 yards	20	662611 <b>03317</b>
72mm x 40m	2.83 inches x 43.7 yards	12	699573 <b>45065</b>
<b>Blue Core 14-Day Tape</b>			
36mm x 54.8m	1-1/2" x 60 yards	24	076607 <b>21954</b>
48mm x 54.8m	2" x 60 yards	24	076607 <b>21955</b>
<i>Bulk packed as individual rolls</i>			
<b>Fine Line Blue Tape</b>			
3.17mm x 32.9m	1/8 inches x 36 yards	360*	662611 <b>82688</b>
6.35mm x 32.9m	1/4 inches x 36 yards	168*	662611 <b>82686</b>
12.7mm x 32.9m	1/2 inches x 36 yards	78*	662611 <b>82685</b>

\* Master case quantity



Good masking choice for multiple transportation applications

## ANCHOR BRAND HAND MASK

- IPG's Anchor® brand Hand Mask is a pre-folded, high density polyethylene masking film designed for multiple transportation applications
- The thick and durable 12 micron film is corona treated to resist overspray flaking during paint applications
- This special film is designed with a reinforced top edge formulated to prevent the underlying film from sticking
- Designed to work with multiple hand dispensers and the 1" core fits most masking machines.

	<b>54.8M (60YD) ROLL</b>	<b>90' ROLL</b>	<b>180' ROLL</b>
<b>WIDTH</b>	<b>ROLL HEIGHT</b>	<b>PART #</b>	<b>PART #</b>
24"	5.35"	–	087143 <b>00214</b>
48"	8.78"	–	087143 <b>00216</b>
72"	9.57"	087143 <b>00217</b>	–
99"	13.0"	087143 <b>00218</b>	–
<i>Case</i>		12	12



Good multi-purpose choice provides durability and excellent protection

## HIGH DENSITY SHEETING (HDPE)

Our multi-purpose painters' plastic sheeting protects virtually any area from sanding dust and paint overspray with ease – even after repositioning. Our High Density Plastic Sheeting (HDPE) is designed to be one of the strongest most durable products on the market.

- Resists tearing and solvent bleed-through with light weight .31 mil High Density Polyethylene plastic (HDPE)
- Holds in place as it clings to horizontal or vertical surfaces during taping with its natural electrostatic properties
- Attracts and holds sanding debris for a dust-free finish
- Drapes easily over furniture

<b>SIZE</b>	<b>THICKNESS</b>	<b>COLOR</b>	<b>QTY/PACK</b>	<b>PACKS/CASE</b>	<b>PART #</b>
9' x 400'	.31 mil	Clear	1	1	076607 <b>68142</b>
12' x 400'	.31 mil	Clear	1	1	076607 <b>68143</b>

*Also available by the pallet.*



Good choice for all of your masking needs

## GREEN MASKING PAPER

- Made from recyclable virgin wood pulp fiber, recycled fiber, or a combination of the two
- These fibers provide a machine finish kraft paper with non-contaminating cleanliness, sustainability, and superior strength properties
- Smooth paper surface ensures no fiber linting leading to rework
- Flexible, easy to work with and shape; conforms to uneven surfaces

<b>SIZE</b>	<b>3"</b>	<b>6"</b>	<b>12"</b>	<b>18"</b>	<b>20"</b>	<b>24"</b>	<b>36"</b>	<b>46"</b>	<b>69"</b>
<b>DESCRIPTION</b>	<b>PART #</b>	<b>PART #</b>	<b>PART #</b>	<b>PART #</b>	<b>PART #</b>	<b>PART #</b>	<b>PART #</b>	<b>PART #</b>	<b>PART #</b>
(750' boxed)	699573 <b>13146</b>	699573 <b>13147</b>	699573 <b>13148</b>	699573 <b>13149</b>	699573 <b>13151</b>	699573 <b>13152</b>	699573 <b>13153</b>	699573 <b>13154</b>	699573 <b>13155</b>
<i>Logs/Case</i>	12/1	6/1	3/1	2/1	1/1	1/1	1/1	1/1	1/1

*Order per number of logs:*

*Each "log" is a total of 36" wide – comprised of the width of the individual roll in inches x the number of rolls/box, e.g. 6" roll x 6 rolls in the box = one 36" wide log; 12" roll x 3 rolls in the box = one 36" wide log, etc., except for the 24" and 36" rolls which are single logs.*





A micro-fiber is a single fiber with a thickness less than a human hair that has been split 16 times and woven into various products. The surface area of a micro-fiber product is increased over 15 times, creating millions of spaces between the fibers which trap dirt, grime or liquids, making this product one of the most absorbent materials. These cloths save you labor, time, and additional costs of multiple cleaning products and chemicals.

**Applications:**

**Cleaning Cloth:** Used for general-purpose wet or dry applications. Works best when sprayed with a light water mist to deep clean.

**Dry Tack Cloth:** This woven terry cloth has a low profile to resist snagging and help pick up embedded debris.

**Polishing Cloth:** Streak-free cleaning of mirrors, optical lens and highly-polished items.

**Other:**

Color-coded for easy identification

Cleaning Cloth: Blue

Dry Tack Cloth: Red

Polishing Cloth: Yellow

**Machine Used:**



HAND  
APPLICATION

**TECH TIP**

- Use these micro-fiber cloths dry for general cleaning
- To remove spills, stains or grime, lightly dampen the cloth for best results
- All micro-fiber cloths can be used with or without chemicals
- Micro-fiber cloths can be washed up to 300+ times without losing cleaning and trapping abilities
- Clean often for best results



It is the user's responsibility to refer to and comply with all safety regulations.



DESCRIPTION	COLOR	STD. PKG.	PART #
<b>Micro-Fiber Cleaning Cloth</b> 16" x 16"	Blue	20	076607 <b>05300</b>
<b>Micro-Fiber Dry Tack Cloth</b> 16" x 16"	Red	20	076607 <b>04025</b>
<b>Micro-Fiber Polishing Cloth</b> 16" x 16"	Yellow	20	076607 <b>05301</b>

## 100 Years of Safety Leadership

The year 2016 marked the 100-year anniversary of the leadership of the former Norton Company in the creation of the first ever safety code for abrasives.

In 1916, following more than a decade of safety research, advocacy, and leadership by the Norton Company (now Norton | Saint-Gobain Abrasives), "The Safety Code for the Use and Care of Abrasive Wheels" was published. This 13-page booklet, containing an unprecedented set of safety device recommendations and procedures, was the spark that changed the entire future of the abrasives industry.

In the 1970s, this code received the ultimate endorsement when selected by OSHA as the basis of new federal regulations concerning abrasive wheel machinery. Today, the ever-evolving "Safety Requirements for the Use, Care and Protection of Abrasive Wheels" (commonly known as the ANSI B7.1 standard) continues to mirror the latest technologies and remains the global authoritative abrasives safety standard.

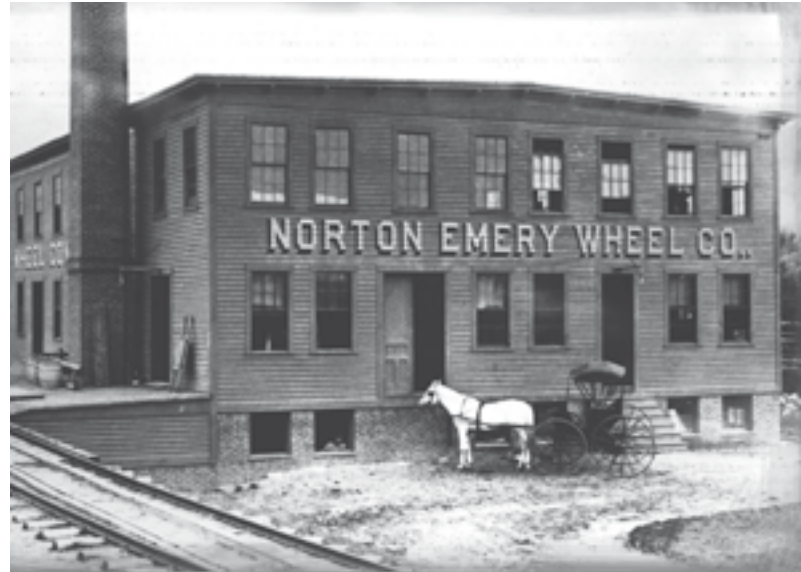

## Breakages/Personal Injury

In the event of on-machine breakage of Norton abrasive products, call your local Norton distributor immediately. Whether involving personal injury or not, the abrasive user should leave the equipment and other evidence undisturbed until a Norton sales representative has been notified and conducts an investigation. Prompt action on the part of abrasive users, distributor, and Norton sales personnel is important to ensure swift determination of the breakage cause and to guard against recurrence.



It is the user's responsibility to refer to and comply with ANSI B7.1 and B7.7 – Contact us for a free copy.



### Safety Poster

(Form # 7868-English, 7868-French, 7868-Spanish)

To order this poster for your shop,  
<mailto:nortonliterature@saint-gobain.com>

## Abrasive Safety References



### Safety Information on the Web

Norton website [nortonsga.us/safety](http://nortonsga.us/safety)

UAMA (United Abrasives Manufacturers Association) website at  
<http://www.safety.uama.org>

## YouTube

### Safety Videos

Watch our videos on: [YouTube.com/NortonAbrasives](https://www.youtube.com/NortonAbrasives)

- Safety, It's The Smart Thing To Do (Safety information for portable grinding and cutting wheels)
- Foundry Safety
- First in Precision Grinding Safety
- Proper Grinding Wheel Mounting
- Railroad Abrasive Safety
- Coated Abrasive Belt and Disc Safety













## UAMA Approved Safety Icons

The UAMA has approved a new set of standardized icons to be used throughout the Abrasive industry to convey safety information to the users. Below are the approved icon types and their definitions.

ICON TYPES	EXAMPLE
<p><b>Safety Icon:</b> A pictorial whose purpose is to relay safety related information to the user.</p>	
<p><b>Hazard Alert Icon:</b> This type of safety icon conveys information primarily related to the nature of a hazard. It contains a graphical depiction of the hazard drawn within a yellow equilateral triangle.</p>	
<p><b>Prohibition Icon:</b> This type of safety icon conveys actions that should not be taken. It consists of a red circular band with a 45° diagonal red band from upper left to lower right. The icon contains a black depiction of what should not be done within the red band on a white background.</p>	
<p><b>Mandatory Action Icon:</b> This type of safety icon conveys actions that should be taken to avoid hazards. It consists of a white image within a solid blue or black circular surround shape.</p>	
<p><b>Proper Machine Use Icon:</b> This type of icon is designed to show the use of the wheel on a proper machine. The icon can be a bit more realistic to show components such as a safety guard and an auxiliary handle. The recommended angle of use may also be depicted.</p>	

ICON	MEANING	ICON	MEANING
	Improper use may break wheel and cause serious injury or death.		Always use wheel guard for angle grinder.
	No side grinding. Cutting only.		Always use wheel guard for non-portable machine.
	No side grinding. Cutting only		Protect your eyes.
	No cutting. Side grinding only.		Protect your face.
	No cutting. Side grinding only, grouped icon.		Protect your lungs against dust.

## UAMA Approved Safety Icons *continued*

ICON	MEANING	ICON	MEANING
	Do not use a damaged wheel.		Protect your hearing.
	Do not use on High Speed Gas Saws.		Protect your eyes and face.
	Do not use on Angle Grinders.		Protect your eyes and hearing. Combined icon.
	Do not use on die grinders		Protect your eyes, ears and lungs.
	Warning alert symbol.		Protect your hands.
	Read OSHA and ANSI B7.1.		Use matched diameter, relieved flanges.
	Read OSHA and ANSI B7.1. Visit the industry safety page: <a href="http://www.safety.UAMA.org">www.safety.UAMA.org</a>		

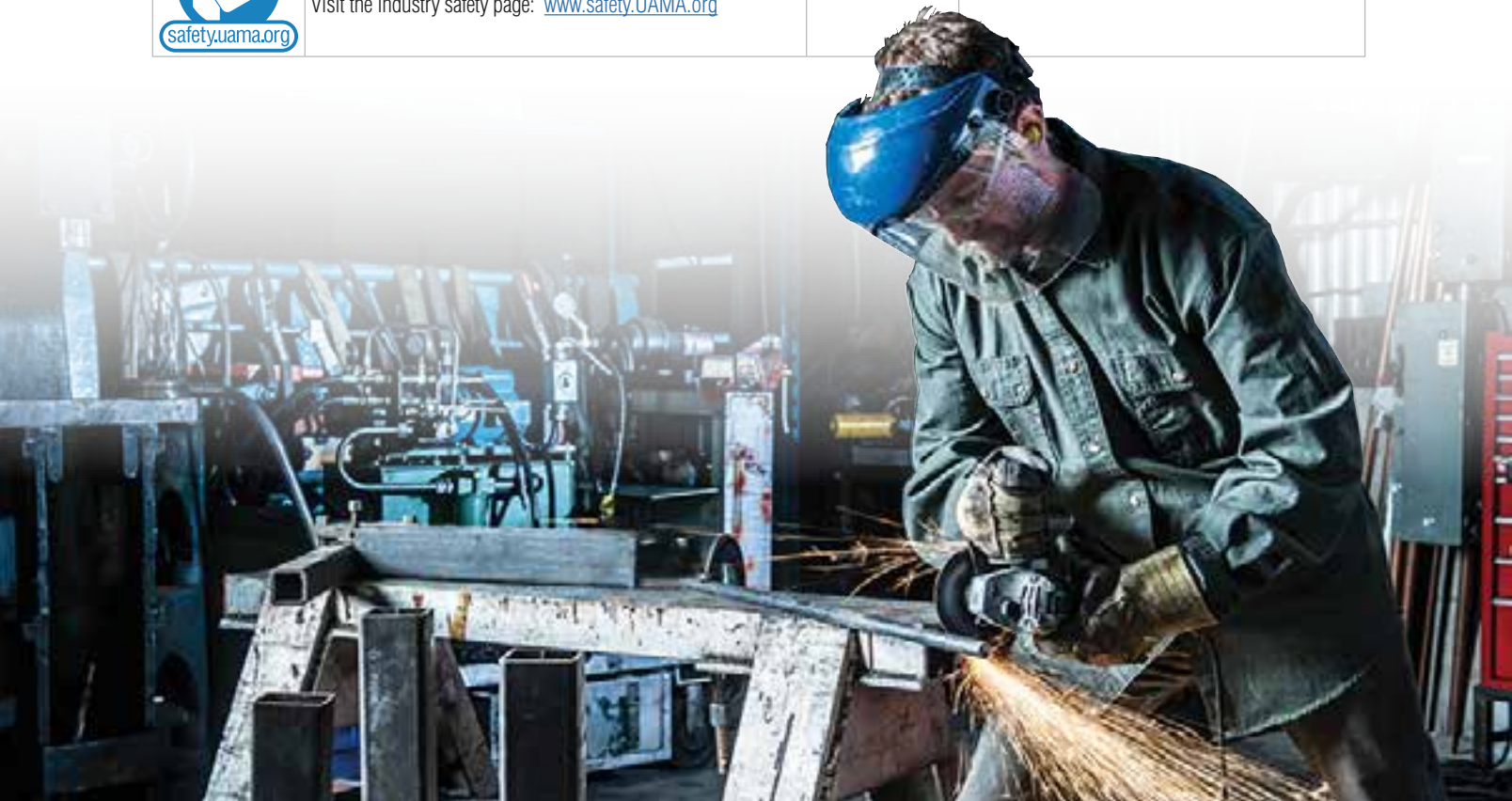

# Coated Abrasive Do's and Don'ts

## Coated Abrasive Disc and Wheel Safety Do's and Don'ts

### Warning







Improper use may cause wheel breakage and serious injury. Comply with ANSI B7.7, OSHA and safety guide provided with the package. Always follow all manufacturer's recommended procedures and safety instructions. Never exceed tool manufacturer's maximum operating speed.

Exposure to DUST generated from workpiece and/or abrasive materials can result in lung damage and/or other physical injury. Use dust capture or local exhaust as stated in the SDS. Wear government-approved respiratory protection and eye and skin protection. Failure to follow this warning can result in serious lung damage and/or physical injury.

Lead Poisoning can develop as a result of inhalation and/or ingestion of the dust generated from sanding any product containing lead, including lead based paint. Lead Poisoning is an illness which can permanently damage the body's physical, neurological and/or reproductive systems. Care must be taken to avoid the inhalation and/or ingestion of dust containing lead

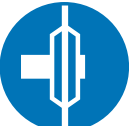
	DO'S	DON'TS
<b>INSPECT / STORAGE / SPEED</b>  	<ul style="list-style-type: none"> <li>• <b>DO</b> read all manuals, operating instructions and warnings</li> <li>• <b>DO</b> read SDS for the disc/wheel and the work-piece material.</li> <li>• <b>DO</b> check all products for damage before mounting.</li> <li>• <b>DO</b> make sure the machine speed does not exceed the speed marked on the package or back up pad.</li> <li>• <b>DO</b> store products prior to use at 35 – 50% relative humidity and 60 – 80°F.</li> </ul>	<ul style="list-style-type: none"> <li>• <b>DON'T</b> use products that have been dropped or damaged.</li> <li>• <b>DON'T</b> use on machines that do not show a MAX RPM speed.</li> </ul>
<b>MOUNT / GUARD</b>  	<ul style="list-style-type: none"> <li>• <b>DO</b> use the wheel guard provided with machine. Position it so it protects the operator and covers the wheel.</li> <li>• <b>DO</b> use recommended back up pad or mandrel for the product.</li> <li>• <b>DO</b> run wheels ONLY in direction of directional arrow stenciled on wheel and in core (except Unified Wheels, which can be run in either direction).</li> <li>• <b>DO</b> run discs/wheels in a protected area for one minute before grinding.</li> </ul>	<ul style="list-style-type: none"> <li>• <b>DON'T</b> remove or modify any guard. ALWAYS use a proper guard.</li> <li>• <b>DON'T</b> use excessive pressure when mounting a wheel. Tighten enough only to hold wheel firmly.</li> </ul>
<b>PROTECT</b>  	<ul style="list-style-type: none"> <li>• <b>DO</b> wear ANSI Z87+ safety glasses and face protection, if required.</li> <li>• <b>DO</b> wear safety shoes, arm guards, leather gloves and aprons.</li> <li>• <b>DO</b> employ dust controls and/or protective measures appropriate to the material being ground.</li> </ul>	<ul style="list-style-type: none"> <li>• <b>DON'T</b> use products near bystanders if they are not wearing protective equipment.</li> </ul>
<b>OPERATE</b> 	<ul style="list-style-type: none"> <li>• <b>DO</b> support work-piece firmly.</li> <li>• <b>DO</b> hold machine firmly in two hands.</li> <li>• <b>DO</b> stop the equipment at once if chattering or vibration occurs during use. Determine cause of the problem and correct before remounting.</li> <li>• <b>DO</b> ease the disc into the work piece at a 5-10o angle to the work piece surface.</li> </ul>	<ul style="list-style-type: none"> <li>• <b>DON'T</b> allow untrained people to handle, store, mount or use discs/wheels.</li> <li>• <b>DON'T</b> twist, jam or bend any wheel.</li> <li>• <b>DON'T</b> force or bump wheel so that the tool motor stalls.</li> <li>• <b>DON'T</b> use discs/wheels in the presence of combustible materials.</li> <li>• <b>DON'T</b> use disc/wheel for applications other than for which they were designed. Refer to ANSI B7.7.</li> </ul>

## Portable Grinding Safety Do's and Don'ts

	DO'S	DON'TS
<b>INSPECT / SPEED</b>  	<ul style="list-style-type: none"> <li>• <b>DO</b> read all manuals, operating instructions and warnings.</li> <li>• <b>DO</b> read SDS for the wheel and workpiece material.</li> <li>• <b>DO</b> check all wheels for cracks or other damage before mounting.</li> <li>• <b>DO</b> make sure the machine does not exceed the maximum operating speed marked on the wheel.</li> <li>• <b>DO</b> store according to ANSI B7.1.</li> </ul>	<ul style="list-style-type: none"> <li>• <b>DON'T</b> use wheels that have been dropped or damaged.</li> <li>• <b>DON'T</b> use on grinders that do not show a MAX RPM.</li> </ul>
<b>MOUNT / GUARD</b>  	<ul style="list-style-type: none"> <li>• <b>DO</b> use an ANSI B7.1 wheel guard. Position it so it protects the operator.</li> <li>• <b>DO</b> be sure wheel hole or threads fit machine properly and that the flanges are clean, flat, undamaged and the proper type.</li> <li>• <b>DO</b> run wheel in a protected area for one minute before grinding.</li> </ul>	<ul style="list-style-type: none"> <li>• <b>DON'T</b> remove or modify any guard. ALWAYS use a proper guard.</li> <li>• <b>DON'T</b> alter a wheel or force it on to the spindle.</li> <li>• <b>DON'T</b> mount more than one wheel on an arbor.</li> <li>• <b>DON'T</b> use excessive pressure when mounting a wheel. Tighten enough only to hold wheel firmly.</li> </ul>
<b>PROTECT</b>  	<ul style="list-style-type: none"> <li>• <b>DO</b> wear ANSI Z87+ safety glasses and face protection, if required.</li> <li>• <b>DO</b> wear gloves, hearing and body protection.</li> <li>• <b>DO</b> employ dust controls and/or protective measures appropriate to the material being ground.</li> <li>• <b>DO</b> comply with OSHA regulations 29 CFR 1926.1153 when working on materials containing crystalline silica such as concrete.</li> </ul>	<ul style="list-style-type: none"> <li>• <b>DON'T</b> use wheels near bystanders if they are not wearing protective equipment.</li> </ul>
<b>OPERATE</b> 	<ul style="list-style-type: none"> <li>• <b>DO</b> support work-piece firmly.</li> <li>• <b>DO</b> hold grinder firmly with two hands.</li> </ul>	<ul style="list-style-type: none"> <li>• <b>DON'T</b> allow untrained people to handle, store, mount or use wheels.</li> <li>• <b>DON'T</b> use grinding wheels or cutting wheels on pistol grip air Sanders.</li> <li>• <b>DON'T</b> use any cutting wheel for grinding nor apply side pressure on a cutting wheel. Use for CUTTING ONLY.</li> <li>• <b>DON'T</b> use a cutting wheel to cut curves. Cut in straight lines only.</li> <li>• <b>DON'T</b> twist, bend or jam any wheel.</li> <li>• <b>DON'T</b> force or bump wheel so that the tool motor slows or stalls.</li> <li>• <b>DON'T</b> use wheels in the presence of combustible materials.</li> <li>• <b>DON'T</b> use wheels for applications other than for which they were designed.</li> </ul>

### Dangerous Pairing: Die Grinders and Cut-off Wheels

While die grinders and portable cut-off tools may look similar, they are by no means interchangeable. Several crucial differences exist between the two handheld machines.

#### GUARD

Cut-off wheels must be used on guarded machines for the safety of the operator and bystanders.

#### SPEED

Cut-off wheels must be used at or below their maximum operating speed, marked clearly on the side of the wheel. Excessive speed can result in breakage and serious personal injury.

Die grinders often operate above 25,000 rpm and therefore are too fast for abrasive wheels. The speed hazard is increased by the absence of a guard. Portable cut-off tools, however, rotate at speeds compatible with the abrasive wheels for which they are designed. And, their guards prevent use of an oversize wheel.

#### MOUNTING

Cut-off wheels must be mounted between proper flanges, as described in the national safety standard for abrasive wheels, ANSI B7.1. Die grinders make use of a collet for mounting

Portable cut-off tools use flanges for mounting, flanges designed according to the ANSI B7.1 safety standard.

Now that you have learned the three crucial differences between die grinders and portable cut-off tools – GUARD, SPEED and MOUNTING – be on watch for the dangerous pairing of cut-off wheels and die grinders, and warn your friends and colleagues of the same.

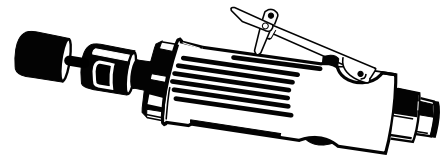

Die Grinder

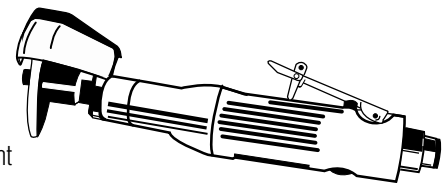

Portable Cut-off Tool

# Starting a Grinding Wheel / Ring Test



Pistol Grip Air Sander

## A Deadly Equation

Pistol Grip Air Sander + Grinding Wheel = Certain Injury!

- Never use a high-speed air sander as a portable grinder
- Use only sanding discs specifically designed for sanders
- Because the speed of these sanders far exceeds the maximum rated speeds for grinding wheels, a potentially lethal wheel breakage might occur

## Starting a Grinding Wheel

### ANSI's Procedure for Starting an Abrasive Wheel

This article is designed to remind users of the proper procedure when starting a machine with a new abrasive wheel mounted on it, starting a machine after the machine and wheel have been stored for a period of time, or remounting a wheel. ANSI B7.1 requires the following procedure when starting a newly mounted grinding wheel.

### 9.8 Starting the Wheel (Requirements)

All abrasive wheels shall be run at operating speeds with the safety guard in place or in a protected enclosure for at least one minute before applying work. During this time no one shall stand in front of or in line with the wheel. (See section 4, for safety guard requirements.) This provision shall apply each time one of the following conditions occur: a) a new wheel has been mounted; or b) a used wheel has been remounted.

### E 9.8 Starting the Wheel (Explanatory Information)

An abrasive wheel may be damaged in shipment or storage, or the wheel may be subjected to improper, excessive stresses during mounting. Wheels which have been damaged or are under excessive stress, are likely to fracture within the first minute of rotation at operating speed. While this procedure is most important at the time when an abrasive wheel is mounted or remounted, damage may also occur to a wheel during a shut down of the machine on which it is mounted. The user should evaluate the circumstances and length of machine shut down to determine additional times that the operating rule should be followed.

Improper wheel mounting is a major cause of wheel breakages. Always use proper mounting procedures as outlined in ANSI B7.1, machine manufacturer's instructions and those supplied with the abrasive wheel. Be safe, know and follow the rules!



## How to Perform a Ring Test on a Grinding Wheel

One method of grinding wheel inspection is called ring testing. OSHA, ANSI and the grinding wheel manufacturers require this method of grinding wheel inspection. It must be performed BEFORE the wheel is mounted on a grinding machine. Ring testing depends on the damping characteristics of a cracked wheel to alter the sound emitted when the wheel is tapped lightly. It is subject to interpretation by the inspector and is primarily applicable to vitrified bonded wheels. To perform the ring test, wheels should be tapped gently with a light nonmetallic implement, such as the handle of a screw driver for light wheels, or a wooden mallet for heavier wheels.

- Tap wheels about 45 degrees each side of the vertical line and about 1" or 2" from the periphery. Rotate the wheel 45 degrees and repeat the test.
- Large and thick wheels may be given the ring test by striking the wheel on the periphery rather than the side of the wheel.
- A sound and undamaged wheel will give a clear tone. If cracked, there will be a dead sound and not a clear ring and the wheel should not be used.
- Wheels must be dry and free of sawdust when applying the ring test, otherwise the sound may be deadened. The ring test is not applicable to certain wheels because of their size, shape or composition.

# Wheel Speed Conversion Table

## Conversion Table – Wheel Speeds

REVOLUTIONS PER MINUTE FOR VARIOUS DIAMETERS OF GRINDING WHEELS TO GIVE SURFACE SPEED IN FEET PER MINUTE AS INDICATED (FOR WHEEL MARKING PURPOSES THE CALCULATED RPM FIGURES LISTED BELOW ARE ROUNDED OFF TO THE NEXT 5)

Surface Speed in Feet Per Minute (SFPM)

Diameter of Wheel in Inches	Revolutions Per Minute (RPM)															
	6,500	7,000	7,500	8,000	8,500	9,000	9,500	10,000	12,000	12,500	14,200	16,000	16,500	17,000	19,685	20,000
1	24,828	26,737	28,647	30,558	32,467	34,377	36,287	38,196	45,836	47,745	54,240	61,116	63,025	64,935	75,190	76,395
2	12,414	13,368	14,328	15,278	16,238	17,188	18,143	19,098	22,918	23,875	27,120	30,558	31,510	32,465	37,595	38,195
3	8,276	8,913	9,549	10,186	10,822	11,459	12,096	12,732	15,278	15,915	18,080	20,372	21,010	21,645	25,065	25,465
4	6,207	6,685	7,162	7,640	8,116	8,595	9,072	9,549	11,459	11,940	13,560	15,278	15,755	16,235	18,800	19,100
5	4,966	5,348	5,730	6,112	6,494	6,876	7,258	7,640	9,168	9,550	10,850	12,224	12,605	12,985	15,040	15,280
6	4,138	4,456	4,775	5,092	5,411	5,729	6,048	6,366	7,639	7,960	9,040	10,186	10,505	10,820	12,530	12,730
7	3,547	3,820	4,092	4,366	4,638	4,911	5,183	5,456	6,548	6,820	7,750	8,732	9,005	9,275	10,740	10,915
8	3,103	3,342	3,580	3,820	4,058	4,297	4,535	4,775	5,729	5,970	6,780	7,640	7,880	8,115	9,400	9,550
9	2,758	2,970	3,182	3,396	3,606	3,820	4,032	4,244	5,092	5,305	6,030	6,792	7,000	7,215	8,355	8,490
10	2,483	2,674	2,865	3,056	3,247	3,438	3,629	3,820	4,584	4,775	5,425	6,112	6,300	6,495	7,520	7,640
12	2,069	2,228	2,386	2,546	2,705	2,864	3,023	3,183	3,820	3,980	4,520	5,092	5,250	5,410	6,265	6,365
14	1,773	1,910	2,046	2,182	2,319	2,455	2,592	2,728	3,274	3,410	3,875	4,366	4,500	4,640	5,370	5,455
16	1,552	1,672	1,791	1,910	2,029	2,149	2,268	2,387	2,865	2,985	3,390	3,820	3,940	4,060	4,700	4,775
18	1,379	1,485	1,591	1,698	1,803	1,910	2,016	2,122	2,546	2,655	3,015	3,396	3,500	3,605	4,175	4,245
20	1,241	1,337	1,432	1,528	1,623	1,719	1,814	1,910	2,292	2,390	2,715	3,056	3,150	3,245	3,760	3,820
22	1,128	1,215	1,302	1,388	1,476	1,562	1,649	1,736	2,084	2,170	2,465	2,776	2,865	2,950	3,420	3,470
24	1,034	1,115	1,194	1,274	1,353	1,433	1,512	1,591	1,910	1,990	2,260	2,546	2,625	2,705	3,135	3,185
26	955	1,028	1,101	1,176	1,248	1,322	1,395	1,468	1,762	1,840	2,090	2,352	2,425	2,495	2,890	2,940
28	887	955	1,023	1,092	1,159	1,228	1,296	1,364	1,637	1,705	1,940	2,182	2,250	2,320	2,685	2,730
30	828	891	955	1,018	1,082	1,146	1,210	1,274	1,528	1,595	1,810	2,056	2,100	2,165	2,505	2,545
32	776	836	895	954	1,014	1,074	1,134	1,194	1,432	1,495	1,695	1,910	1,970	2,030	2,350	2,385
34	730	786	843	898	955	1,011	1,067	1,124	1,348	1,405	1,595	1,796	1,855	1,910	2,210	2,245
36	690	742	795	848	902	954	1,007	1,061	1,273	1,330	1,510	1,698	1,750	1,805	2,090	2,120
38	653	704	754	804	854	904	955	1,006	1,206	1,260	1,430	1,608	1,660	1,710	1,980	2,010
40	620	669	716	764	812	860	908	956	1,146	1,195	1,355	1,528	1,575	1,625	1,880	1,910
42	591	636	682	732	775	818	863	908	1,090	1,140	1,295	1,464	1,500	1,545	1,790	1,820

For intermediate diameters not listed use the formula listed in Section 1.2.10 of ANSI B7.1

SFPM = .262 x wheel diameter in inches x RPM.

To convert meters per second (m/s) to SFPM: m/s x 196.85 = SFPM

To convert SFPM to m/s: SFPM/196.85 = m/s.

To convert RPM to SFPM: Wheel Diameter x RPM x 0.262 = SFPM



## Silica and What You Need to Know

### Background and Health impacts

Silica (SiO<sub>2</sub>) is one of the most common minerals in the earth's crust. Glass, beach sand, silicone and granite are all "silica" materials. Products containing silica have been used for thousands of years in building and is a key ingredient in many products we use every day. There are two forms of silica; crystalline and non-crystalline. Crystalline silica is a mineral that occurs in several forms. Quartz, the most common form, is a component of sand, stone, rock concrete, brick, block and mortar. Non-crystalline silica is found in glass, silicon carbide and silicone.

When rocks containing crystalline silica are cut, crushed, ground, drill or used in similar industrial processes, dust particles are produced. These particles are very fine, at least 100 times smaller than ordinary beach sand – known as respirable crystalline silica or RCS. Inhaling very small or respirable crystalline silica particles is most hazardous and may cause multiple diseases such as silicosis, followed in severe cases by lung cancer.

### Who is at risk from exposure to crystalline silica?

It is estimated that 2.3 million workers are exposed to crystalline silica on the job. The majority of the workers, about 2 million, are in the construction industry. The hazard exists when specific activities create respirable dust that is released into the air.

### The New OSHA Standard

OSHA's recently implemented silica standards for Construction "29 CFR 1926.1153" and General Industry "29 CFR 1910.1053" suggests procedures applicable for work in these environments. This new standard affects all activities that generate silica dust on a jobsite. Trades involving brick, stone, concrete and other materials that are difficult to replace must comply with the standard. This is a change around "process", not specific products.

### Impacts on Industry

Industries affected by this regulation include Construction, Glass manufacturing, Pottery products, Structural clay products, Concrete products, Foundries, Cut stone and Stone products, Railroads, Refractory products and Asphalt products manufacturing to name a few. Always read the Safety Data Sheet for the workpiece and abrasive before use.

The Occupational Safety and Health Administration (OSHA) has a number of available resources to help companies understand the general information and requirements to explain the new regulations including:

OSHA's Crystalline Silica Rule: Construction

<https://www.osha.gov/Publications/OSHA3681.pdf>

OSHA Fact Sheet

<https://www.osha.gov/publications/OSHA3682.pdf>

Small Entity Compliance Guide for Respirable Crystalline Silica Standard for Construction

<https://www.osha.gov/publications/OSHA3902.pdf>

Small Entity Compliance Guide for Respirable Crystalline Silica Standard for General Industry and Maritime

<https://www.osha.gov/publications/OSHA3911.pdf>

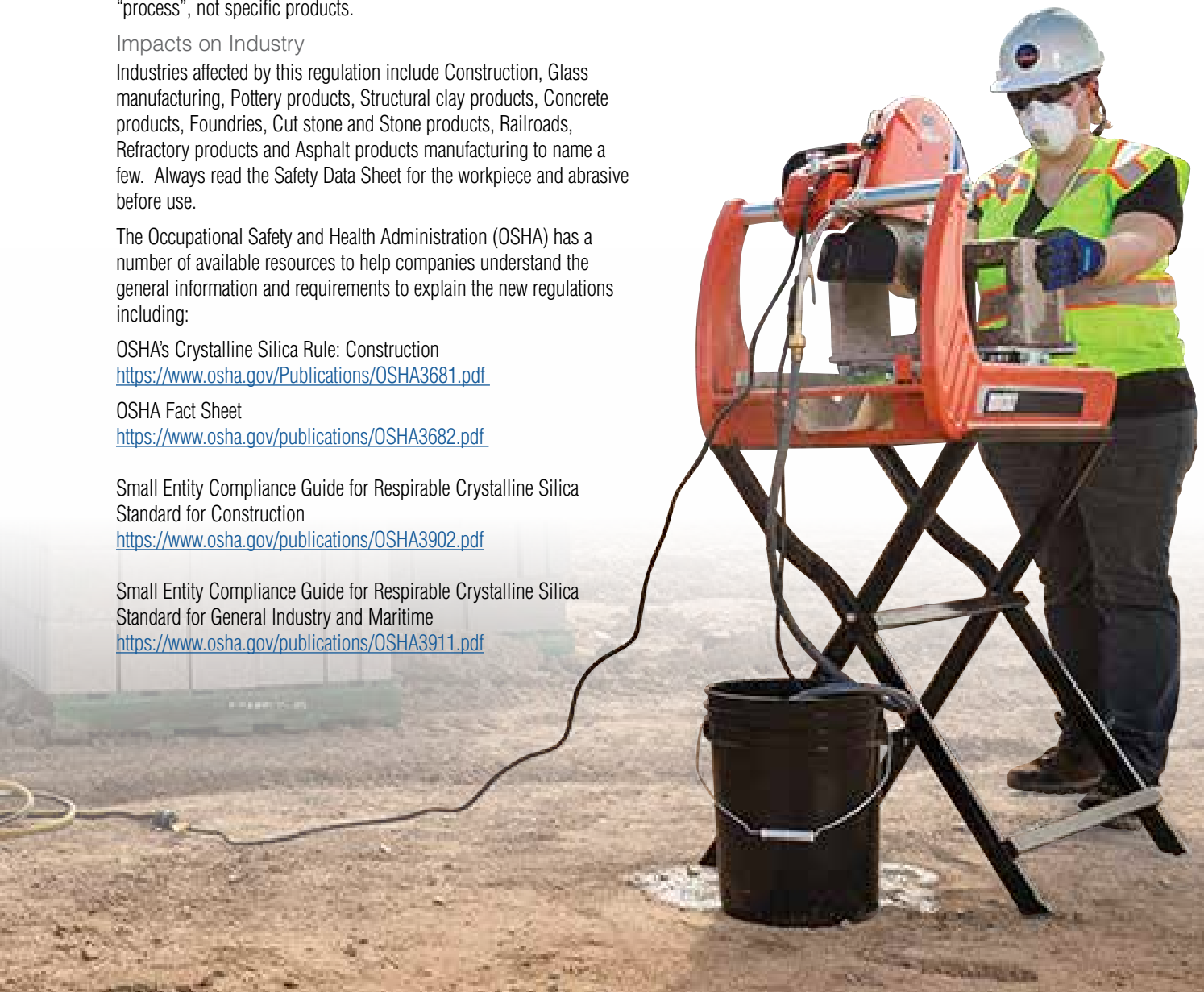

## Product Warranty

WARRANTY – Saint-Gobain Abrasives warrants the products in this catalog to be free from defects in material or workmanship for a period of one year from the date of purchase. Saint-Gobain Abrasives' sole obligation under this warranty shall be to repair or replace, at Saint-Gobain Abrasives' option, any product which is non-conforming provided any such product failure was not caused by a subsequent modification of the product, misuse or a failure to follow any applicable instructions for the product.

EXCEPT FOR THE FOREGOING, SAINT-GOBAIN ABRASIVES EXPRESSLY DISCLAIMS ALL OTHER GUARANTIES AND/OR WARRANTIES, EXPRESS OR IMPLIED, INCLUDING THE WARRANTIES OF MERCHANTABILITY AND FITNESS FOR A PARTICULAR PURPOSE.

## Liability Limitation

SAINT-GOBAIN'S LIABILITY FOR ANY LOSS OR DAMAGE ARISING OUT OF OR RESULTING FROM THE USE OF THE PRODUCT SHALL NOT EXCEED THE PURCHASE PRICE THEREOF, REGARDLESS OF WHETHER SUCH LIABILITY ARISES IN CONTRACT, TORT (INCLUDING WITHOUT LIMITATION NEGLIGENCE OR STRICT LIABILITY), OR OTHERWISE, AND IN NO EVENT SHALL SAINT-GOBAIN BE LIABLE FOR INDIRECT, SPECIAL, INCIDENTAL OR CONSEQUENTIAL DAMAGES OF ANY KIND. NO REPRESENTATIVE OF SAINT-GOBAIN, NOR ANY OF SAINT-GOBAIN'S DISTRIBUTORS OR DEALERS, IS AUTHORIZED TO MODIFY THIS WARRANTY OR ISSUE ANY WARRANTY REGARDING THE PRODUCTS IN THIS CATALOG.

## Product Quality Complaints

All product quality complaints should be submitted to your local Norton Distributor.

## Trademarks

All trademarks used in these pages are trademarks of Saint-Gobain Abrasives unless otherwise indicated.

A275 Original Performance™	Fast Cut™	NorGrip®	Reshaping the World of Precision Grinding™
Abrasive Connection Express®	FastTrack™	NorKut™	Reshaping Your World®
Adalox®	FlexDrum™	NorPor®	RightCut®
Alundum®	FlexEdge™	Norton®	Sand-O-Flex™
AVOS®	Foundry X™	Norton Clipper™	Screen-Bak®
Aztec®	Furioso™	Norton Design® (Parallelogram)	SoftTouch®
Bear-Tex®	Gemini®	Norton Design® (Triple Stripe Design)	Speed-Change™
Because Right Choices Matter™	G-Force™	Norton SG®	Speed-Grip®
Black Ice®	India®	NorZon®	Speed-Lok®
Blaze®	JobPack™	NorZon Plus®	Stick & Sand®
Blue-Bak™	Liquid Ice®	Onyx™	Targa®
Blue-Core™	Long Life™	Pacesetter™	Thin Flex™
BlueFire®	Merit®	Paradigm®	TufBak®
BPR™	MeshPower™	Plyweld®	U-Dex-It™
Century45®	Metalite®	ProSand™	Univel®
Charger™	Mini-Dex™	Pure Ice™	USB™
Classic™	MSL®	QuadroFlex™	Vitrium3®
Clean Bond®	Multi-Air Cyclonic®	Quantum™	Vortex®
Clipper®	Multi-Oilstone®	Rail Cut™	Winter®
Crystolon®	MultiSand™	Rapid Blend®	and others
DiaLast™	The Muscle Behind The Machine®	Rapid Cut™	
Dry Ice®	NEX™	Rapid Finish®	
Duo®	No-Fil®	Rapid Prep™	
Duo Evo™	NORaX®	Rapid Strip®	
Durite®	NorBide®	Red Heat®	

## GET ACCESS TO THE INDUSTRY'S BEST SELECTION OF ABRASIVE SOLUTIONS!

### Contact Us

To place an order, contact our customer service support center with:

- Customer number and contact name
- Any special shipping needs
- Complete product information:
  - » 11-digit Part Number
  - » Product description
  - » Quantity and unit of measure
  - » Price by unit of measure



U.S. Phone: **800-551-4413** Fax: **800-551-4416**

CDN. Phone: **800-263-6565** Fax: **800-561-9490**

Email: [nacustomerservice@saint-gobain.com](mailto:nacustomerservice@saint-gobain.com)



To ensure minimal errors and faster turnaround, using electronic media is preferred for placing orders. For assistance with [www.abrasiveconnection.com](http://www.abrasiveconnection.com) or EDI setup, contact us at:

Email: [abrasive.connection@saint-gobain.com](mailto:abrasive.connection@saint-gobain.com)

Phone: 888-383-2236

### Boost your knowledge and add selling confidence

Sign up for industry leading training from a world leader in abrasives manufacturing. Visit [www.nortonabrasives.com/en-us/norton-tech](http://www.nortonabrasives.com/en-us/norton-tech) to find out more about our Norton Tech online training.

**NORTON** **TECH**  
School of Abrasives



### Put our NEW merchandizing displays to work for you

We offer a complete set of Norton branded merchandising displays and point of sale graphics that can be tailored to your requirements, and support your sales growth for industrial, commercial MRO, and welding distributors. Contact your local Norton sales representative to find out more!



## NORTON

SAINT-GOBAIN

The world leader in abrasives for more than 130 years, the Norton brand offers the widest portfolio of grinding, cutting, blending, finishing and polishing solutions which deliver the highest productivity and cost performance ratio in both stock and made-to-order solutions.

## NORTON

SAINT-GOBAIN

# clipper®

For 80 years, the Clipper brand has been a trusted equipment source on the jobsite. Now, the Norton Clipper brand will cut a new path for future growth with an industry-leading line of diamond products, abrasives, and light equipment to tackle even the toughest construction environment.

## NORTON

SAINT-GOBAIN

# MERIT®

The Norton Merit brand offers a comprehensive portfolio of specialty abrasive products for offhand and portable power tools. From quick-change discs and cartridge rolls to flap wheels - feel the power behind Norton Merit.

## NORTON

SAINT-GOBAIN

# WINTER

The world's leading brand for high-quality, innovative diamond and cBN precision grinding products for the automotive, aerospace, bearing, tools and electronics industries. Norton Winter is quality and precision at its finest.

### BEST

Highest Productivity Lowest Total Cost

### BETTER

Excellent Blend of Performance and Price

### GOOD

Consistent Performance – Low Initial Price

[www.facebook.com/NortonAbrasivesNA](http://www.facebook.com/NortonAbrasivesNA) | [www.youtube.com/NortonAbrasives](http://www.youtube.com/NortonAbrasives) | [www.nortonabrasives.com](http://www.nortonabrasives.com)

#### USA CUSTOMER SERVICE:

Toll Free Phone: 1 (800) 551-4413  
Toll Free Fax: 1 (800) 551-4416

#### CANADA CUSTOMER SERVICE:

Toll Free Phone: 1 (800) 263-6565  
Toll Free Fax: 1 (800) 561-9490

FORM #7362 REV. 05/19

© Saint-Gobain May 2019.

Norton, Bear-Tex, Clipper, Merit, and Winter are registered trademarks of Saint-Gobain Abrasives.



NO-RISK TEST

